

# Models 3508 and 3504 Process Controller

## User Manual

Part No HA027988\_17

Date December 2015



**Eurotherm**<sup>®</sup>

by **Schneider** Electric



This page is intentionally blank

# 3508 and 3504 Process Controllers

## User Manual

### List of Sections

<b>Warning Battery Life</b> .....	<b>10</b>
<b>1. CHAPTER 1 INSTALLATION AND OPERATION</b> .....	<b>12</b>
1.1 What Instrument Do I Have?.....	12
1.1.1 Contents of Package.....	12
1.1.2 Orderable Accessories.....	12
1.2 3504 and 3508 Ordering Code.....	13
1.2.1 Input and Output Modules.....	13
1.3 Configuration Code (Quick Start Code).....	14
1.4 How to Install the Controller.....	16
1.4.1 Dimensions.....	16
1.4.2 To Install the Controller.....	17
1.4.3 Unplugging the Controller.....	17
1.5 Electrical Connections.....	18
1.5.1 Wire Sizes.....	18
1.6 Standard Connections.....	19
1.6.1 PV Input (Measuring Input).....	19
1.6.2 Digital I/O.....	20
1.6.3 Digital (Logic) Outputs.....	20
1.6.4 Digital (Logic) Outputs used to power a remote 2 wire transmitter.....	20
1.6.5 Digital (Logic) Outputs used to power a remote 3 wire transmitter.....	20
1.6.6 Digital (Logic) Outputs used to power a remote 4 wire transmitter.....	20
1.6.7 Relay Output.....	21
1.6.8 Power Supply Connections.....	21
1.7 Plug in I/O Module Connections.....	22
1.7.1 Relay (2 pin) and Dual Relay Module.....	22
1.7.2 Change Over Relay.....	22
1.7.3 Triple Logic and Single Isolated Logic Output.....	22
1.7.4 Triac and Dual Triac.....	22
1.7.5 DC Control.....	23
1.7.6 DC Retransmission.....	23
1.7.7 Dual DC Output.....	23
1.7.8 High Resolution DC Retransmission & Transmitter Power Supply.....	23
1.7.9 Triple Logic Input.....	23
1.7.10 Triple Contact Input.....	23
1.7.11 24V Transmitter Supply.....	24
1.7.12 Potentiometer input.....	24
1.7.13 Transducer Power Supply.....	24
1.7.14 Analogue Input (T/C, RTD, V, mA, mV).....	25
1.7.15 Analogue Input (Zirconia Probe).....	25
1.7.16 Zirconia Probe Construction.....	26
1.7.17 Zirconia Probe Screening Connections.....	26
1.8 Digital Communications Connections.....	27
1.8.1 Modbus (H or J Module), EIBisynch, Broadcast and Modbus Master.....	27
1.8.2 DeviceNet Wiring.....	28
1.8.3 Example DeviceNet Wiring Diagram.....	28
1.8.4 Profibus.....	29
1.8.5 Ethernet (ModBus TCP).....	30
1.8.6 I/O Expander.....	31
1.8.7 IO Expander Connections.....	31
1.8.8 Example Wiring Diagram.....	32
1.8.9 Snubbers.....	32
<b>2. CHAPTER 2 GETTING STARTED</b> .....	<b>33</b>
2.1 Quick Start - New Controller (Unconfigured).....	33
2.1.1 To Configure Parameters in Quick Start Mode.....	34
2.1.2 Quick Start Parameters.....	34
2.2 To Re-enter Quick Start Mode.....	39
2.2.1 Power up After a Quick Start Configuration.....	39
2.2.2 Power up After a Full Configuration.....	39
2.3 Normal Operation.....	40
2.3.1 Beacon Display and Description.....	40
2.4 The Operator Buttons.....	41

2.5	To Set the Required Temperature (Setpoint) .....	42
2.6	To Select Auto/Manual Operation .....	43
2.6.1	Bumpless Transfer .....	43
2.7	Alarm Indication .....	44
2.7.1	To Acknowledge an Alarm Press  and  (Ack) together .....	44
2.7.2	Sensor Break Indication .....	44
2.8	Message Centre .....	45
2.8.1	Summary Pages .....	45
2.8.2	How to Edit Parameters .....	47
2.8.3	Program Status Page .....	48
2.8.4	Control Summary Page .....	53
<b>3.</b>	<b>CHAPTER 3 ACCESS TO FURTHER PARAMETERS .....</b>	<b>54</b>
3.1	Level 3 .....	54
3.2	Configuration Level .....	54
3.3	To Select Different Levels of Access .....	55
3.4	Access Parameter List .....	56
<b>4.</b>	<b>CHAPTER 4 FUNCTION BLOCKS .....</b>	<b>58</b>
4.1	To Access a Function Block .....	59
4.1.1	Sub-Lists or Instances .....	59
4.1.2	To Access a Parameters in a Function Block .....	59
4.1.3	To Change the Value of a Parameter .....	60
4.2	Navigation Diagram .....	61
<b>5.</b>	<b>CHAPTER 5 FUNCTION BLOCK WIRING .....</b>	<b>62</b>
5.1	Soft Wiring .....	63
5.1.1	Wiring Example .....	63
5.1.2	Wiring Through the Operator Interface .....	64
5.1.3	To Remove a Wire .....	65
5.1.4	Wiring a Parameter to Multiple Inputs .....	66
5.1.5	Wiring Using iTools .....	66
5.1.6	Wiring Floats with Status Information .....	67
5.1.7	Edge Wires .....	69
5.1.8	Operation of Booleans and Rounding .....	70
<b>6.</b>	<b>CHAPTER 6 INSTRUMENT CONFIGURATION .....</b>	<b>71</b>
6.1	What Is Instrument Configuration? .....	71
6.2	To Select Instrument Configuration .....	71
6.3	Function Block Options .....	71
6.3.1	To Enable Function Blocks .....	72
6.4	Instrument Options .....	74
6.5	Display Formatting .....	75
6.5.1	To Customise the Display .....	75
6.5.2	Bar Graph (3504 Only) .....	77
6.6	Instrument information .....	78
6.7	Instrument Diagnostics .....	79
<b>7.</b>	<b>CHAPTER 7 PROCESS INPUT .....</b>	<b>81</b>
7.1	To select PV Input .....	81
7.2	Process Input Parameters .....	81
7.2.1	Input Types and Ranges .....	83
7.2.2	CJC Type .....	84
7.2.3	Display Units .....	85
7.2.4	Sensor Break Value .....	85
7.2.5	Fallback .....	85
7.2.6	PV Input Scaling .....	86
7.2.7	PV Offset .....	87
7.2.8	Two Point Offset .....	88
<b>8.</b>	<b>CHAPTER 8 LOGIC INPUT/OUTPUT .....</b>	<b>89</b>
8.1	To select Logic IO list .....	89
8.2	Logic IO Parameters .....	89
8.2.1	Output State When the Controller is in Standby .....	92
8.2.2	Cycle Time and Minimum OnTime Algorithms .....	92
8.2.3	Example: To Configure a Time Proportioning Logic Output .....	93
8.2.4	Example: To Calibrate a VP Output .....	93
8.2.5	Logic Output Scaling .....	94
8.2.6	Example: To Scale a Proportioning Logic Output .....	94



<b>9. CHAPTER 9 AA RELAY OUTPUT .....</b>	<b>95</b>
9.1 To Select AA Relay List.....	95
9.2 AA Relay Parameters .....	95
9.2.1 Example: To Wire the AA Relay to an Alarm .....	97
9.2.2 Relay Output Scaling .....	97
<b>10. CHAPTER 10 MODULE CONFIGURATION.....</b>	<b>98</b>
10.1 To Fit a New Module .....	99
10.2 Module Identification.....	100
10.3 Module Types .....	100
10.3.1 Relay, Logic or Triac Outputs.....	100
10.3.2 Single Isolated Logic Output .....	103
10.3.3 DC Control, Dual DC Control, or DC Retransmission Output.....	104
10.3.4 High Resolution DC Output.....	105
10.3.5 Analogue Input.....	106
10.3.6 Input Types and Ranges .....	108
10.3.7 Display Units.....	108
10.3.8 Triple Logic Input and Triple Contact Input .....	109
10.3.9 Potentiometer Input.....	109
10.3.10 Transmitter Power Supply .....	110
10.3.11 Transducer Power Supply .....	111
10.4 Module Scaling .....	112
10.4.1 Analogue Input Scaling and Offset.....	112
10.4.2 Two Point Offset .....	113
10.4.3 Relay, Logic or Triac Output Scaling.....	113
10.4.4 Analogue Output Scaling .....	113
10.4.5 Potentiometer Input Scaling.....	114
<b>11. CHAPTER 11 IO EXPANDER.....</b>	<b>115</b>
11.1 To Configure the IO Expander.....	116
11.1.1 IO Expander Parameters .....	116
<b>12. CHAPTER 12 ALARMS .....</b>	<b>117</b>
12.1 Further Alarm Definitions.....	117
12.2 Analogue Alarms .....	118
12.2.1 Analogue Alarm Types.....	118
12.3 Digital Alarms .....	119
12.3.1 Digital Alarm Types.....	119
12.3.2 Alarm Relay Output.....	119
12.3.3 How Alarms are Indicated .....	120
12.3.4 To Acknowledge an Alarm .....	120
12.4 Analogue Alarm Parameters .....	121
12.4.1 Example: To Configure Alarm 1 .....	123
12.5 Digital Alarm Parameters.....	124
12.6 Diagnostic Alarms.....	125
12.7 To Set Up Alarms Using iTools .....	125
<b>13. CHAPTER 13 BCD INPUT .....</b>	<b>126</b>
13.1 BCD Parameters .....	126
13.1.1 Example: To wire a BCD Input.....	127
<b>14. CHAPTER 14 DIGITAL COMMUNICATIONS .....</b>	<b>128</b>
14.1.1 EIA232 .....	129
14.1.2 EIA485 .....	129
14.2 Configuration Ports.....	130
14.2.1 IR Clip .....	130
14.2.2 CFG Clip .....	130
14.2.3 USB CPI Clip .....	130
14.2.4 Cloning of Configuration Port Settings .....	131
14.3 Digital Communications Parameters .....	131
14.3.1 Communications Identity.....	133
14.3.2 Protocol.....	133
14.3.3 Baud Rate .....	134
14.3.4 Parity.....	134
14.3.5 Communication Address .....	134
14.3.6 Comms Delay .....	134
14.3.7 818, 902/3/4 Style Programmer .....	135
14.3.8 Status Words .....	135
14.4 Ethernet Protocol.....	136
14.4.1 Ethernet Parameters.....	136
14.4.2 Instrument setup .....	136
14.4.3 MAC address display .....	137

14.4.4	DHCP Settings .....	137
14.4.5	Network Connection .....	137
14.4.6	Dynamic IP Addressing .....	137
14.4.7	Fixed IP Addressing .....	137
14.4.8	Additional notes .....	137
14.4.9	iTools Setup .....	138
14.4.10	Unit Ident Enable .....	138
14.5	Profibus Protocol .....	139
14.5.1	Profibus Parameters .....	139
14.5.2	I/O Data Exchange .....	140
14.5.3	Network Configuration .....	140
14.5.4	To Install the Eurotherm GSD Editor .....	141
14.5.5	Launch the GSD Editor .....	142
14.5.6	Demand Data .....	143
14.6	DeviceNet Protocol .....	151
14.6.1	Devicenet Parameters .....	151
14.7	Comms Indirection Table .....	152
14.8	Broadcast Communications .....	153
14.8.1	3500 Broadcast Master .....	153
14.8.2	Wiring Connections - Broadcast Communications .....	154
14.8.3	Example: To Send SP from the Master to SP in a Slave .....	154
14.9	Modbus Master Communications .....	155
14.9.1	Wiring connections .....	155
14.9.2	Modbus Master Parameters .....	155
14.9.3	Set Up Example .....	158
14.10	Packbit .....	159
14.10.1	Packbit Parameters .....	159
14.11	Unpackbit .....	160
14.11.1	Unpackbit Parameters .....	160
<b>15.</b>	<b>CHAPTER 15 COUNTERS, TIMERS, TOTALISERS, REAL TIME CLOCK.....</b>	<b>161</b>
15.1	Counters .....	161
15.1.1	Counter Parameters .....	162
15.2	Timers .....	163
15.2.1	Timer Types .....	163
15.2.2	On Pulse Timer Mode .....	163
15.2.3	On Delay Timer Mode .....	164
15.2.4	One Shot Timer Mode .....	165
15.2.5	Compressor or Minimum On Timer Mode .....	166
15.2.6	Timer Parameters .....	167
15.3	Totalisers .....	168
15.3.1	Totaliser Parameters .....	169
15.4	Real Time Clock .....	170
15.4.1	Real Time Clock Parameters .....	170
<b>16.</b>	<b>CHAPTER 16 APPLICATION SPECIFIC .....</b>	<b>171</b>
16.1	Humidity Control .....	171
16.1.1	Example of Humidity Controller Connections .....	171
16.1.2	Temperature Control Of An Environmental Chamber .....	172
16.1.3	Humidity Control Of An Environmental Chamber .....	172
16.2	Humidity Parameters .....	172
16.3	Zirconia (Carbon Potential) Control .....	173
16.3.1	Temperature Control .....	173
16.3.2	Carbon Potential Control .....	173
16.3.3	Sooting Alarm .....	173
16.3.4	Automatic Probe Cleaning .....	173
16.3.5	Endothermic Gas Correction .....	173
16.3.6	Clean Probe .....	173
16.3.7	Probe Status .....	173
16.4	Zirconia Parameters .....	174
16.5	Example of Carbon Potential Control Connections .....	181
<b>17.</b>	<b>CHAPTER 17 INPUT MONITOR .....</b>	<b>182</b>
17.1	Maximum Detect .....	182
17.2	Minimum Detect .....	182
17.3	Time Above Threshold .....	182
17.4	Input Monitor Parameters .....	183

<b>18. CHAPTER 18 LOGIC MATHS AND MULTI OPERATORS.....</b>	<b>184</b>
18.1 Logic Operators .....	184
18.1.1 Logic 8 .....	184
18.1.2 Logic Operations.....	185
18.1.3 Logic Operator Parameters.....	186
18.2 Eight Input Logic Operators.....	187
18.2.1 Eight Input Logic Operator Parameters.....	187
18.3 Maths Operators .....	188
18.3.1 Math Operations .....	189
18.3.2 Math Operator Parameters .....	190
18.3.3 Sample and Hold Operation.....	191
18.4 Eight Input Analog Multiplexers.....	192
18.4.1 Multiple Input Operator Parameters.....	192
18.4.2 Fallback.....	192
18.5 Multi Input Operator.....	193
18.5.1 Number of Inputs .....	193
18.5.2 Input Status.....	193
18.5.3 Number of Valid Inputs .....	193
18.5.4 Cascaded Operation .....	194
18.5.5 Fallback Strategy for Multi Input Block.....	194
18.5.6 Multi Operator Parameters.....	195
<b>19. CHAPTER 19 INPUT CHARACTERISATION .....</b>	<b>196</b>
19.1 Input Linearisation .....	196
19.1.1 Compensation for Sensor Non-Linearities .....	197
19.1.2 Input Linearisation Parameters .....	198
19.2 Polynomial .....	199
<b>20. CHAPTER 20 LOAD.....</b>	<b>201</b>
20.1 Load Parameters .....	201
<b>21. CHAPTER 21 CONTROL LOOP SET UP.....</b>	<b>203</b>
21.1 What is a Control Loop? .....	203
21.2 Control Loop Function Blocks.....	203
21.3 Main Function Block .....	204
21.3.1 Loop Parameters - Main .....	204
21.3.2 Auto/Manual.....	205
21.4 Loop Set Up Function Block .....	206
21.4.1 Types of Control Loop.....	206
21.4.2 Loop Parameters - Set up.....	208
21.5 PID Function Block.....	209
21.5.1 Loop Parameters - PID .....	209
21.5.2 Proportional Band .....	211
21.5.3 Integral Term.....	211
21.5.4 Derivative Term.....	212
21.5.5 Relative Cool Gain .....	212
21.5.6 High and Low Cutback.....	213
21.5.7 Manual Reset.....	213
21.5.8 Integral Hold.....	213
21.5.9 Integral De-bump .....	214
21.5.10 Loop Break .....	214
21.5.11 Gain Scheduling .....	215
21.6 Tuning Function Block .....	216
21.6.1 Loop Response.....	216
21.6.2 Initial Settings.....	216
21.6.3 Automatic Tuning .....	217
21.6.4 Loop Parameters - Auto-Tune.....	218
21.6.5 To Auto Tune a Loop - Initial Settings.....	219
21.6.6 To Start Autotune.....	219
21.6.7 Autotune and Sensor Break.....	219
21.6.8 Autotune and Inhibit or Manual .....	219
21.6.9 Autotune and Gain Scheduling .....	219
21.6.10 Autotune from Below SP – Heat/Cool.....	220
21.6.11 Autotune From Below SP – Heat Only .....	221
21.6.12 Autotune at Setpoint – Heat/Cool .....	222
21.6.13 Failure Modes.....	223
21.6.14 Relative Cool Gain in Well Lagged Processes .....	224
21.6.15 Manual Tuning.....	225
21.6.16 Manually Setting Relative Cool Gain .....	225
21.6.17 Manually Setting the Cutback Values .....	226

21.7	Setpoint Function Block .....	227
21.7.1	Loop Parameters - Setpoint .....	228
21.7.2	Setpoint Limits .....	230
21.7.3	Setpoint Rate Limit.....	230
21.7.4	Setpoint Tracking .....	231
21.7.5	Manual Tracking .....	231
21.8	Output Function Block .....	232
21.8.1	Loop Parameters - Output.....	232
21.8.2	Output Limits.....	236
21.8.3	Output Rate Limit.....	237
21.8.4	Sensor Break Mode .....	237
21.8.5	Forced Output.....	237
21.8.6	Power Feed Forward.....	238
21.8.7	Cooling Algorithm.....	238
21.8.8	Feedforward.....	239
21.8.9	Nudge Raise/Lower .....	239
21.8.10	Effect of Control Action, Hysteresis and Deadband .....	240
21.9	Diagnostics Function Block.....	241
<b>22.</b>	<b>CHAPTER 22 SETPOINT PROGRAMMER .....</b>	<b>242</b>
22.1	Dual Programmer Modes.....	243
22.1.1	SyncStart Programmer.....	243
22.1.2	SyncAll Programmer.....	243
22.1.3	Single Channel Programmer.....	243
22.2	Programmer Types .....	244
22.2.1	Time to Target Programmer.....	244
22.2.2	Ramp Rate Programmer .....	244
22.3	Segment Types.....	245
22.3.1	Rate .....	245
22.3.2	Dwell .....	245
22.3.3	Step.....	245
22.3.4	Time.....	245
22.3.5	GoBack .....	245
22.3.6	Wait.....	246
22.3.7	Call.....	247
22.3.8	End.....	247
22.4	Event Outputs .....	248
22.4.1	PV Event.....	248
22.4.2	Time Event.....	248
22.4.3	User Values .....	250
22.5	Holdback.....	251
22.5.1	Guaranteed Soak.....	251
22.6	PID Select .....	252
22.7	Sync Point – ‘Goback’ Interaction.....	252
22.8	PrgIn1 and PrgIn2.....	253
22.9	Program Cycles .....	253
22.10	Servo.....	253
22.11	Power Fail Recovery.....	254
22.11.1	Ramp back (Power fail during Dwell segments.) .....	254
22.11.2	Ramp back (power fail during Ramp segments).....	254
22.12	Ramp back (power fail during Time-to-target segments) .....	254
22.13	Sensor Break Recovery.....	254
22.14	Operating a Program .....	255
22.14.1	Run .....	255
22.14.2	Reset.....	255
22.14.3	Hold .....	255
22.14.4	Skip Segment .....	255
22.14.5	Advance Segment .....	255
22.14.6	Fast.....	255
22.14.7	Run/Hold/Reset Digital Inputs.....	256
22.15	PV Start.....	257
22.15.1	Example: To Run, Hold or Reset a Program .....	258
22.16	Program Set Up .....	259
22.17	Program Edit .....	263
22.17.1	To Edit a SyncAll Programmer .....	263
22.17.2	To Edit a Syncstart Programmer .....	267
22.17.3	Summary of Parameters which appear for different Segment Types .....	271
22.17.4	To Edit a Single Channel Programmer .....	272
22.17.5	Examples Showing How to Set up and Run Dual Programmers .....	275

22.18	Alternative Ways to Edit a Program .....	277
22.19	Appendix to Chapter 22: Single Programmer Earlier Versions .....	278
22.19.1	Creating or Editing a Single Program .....	278
22.19.2	Sync mode.....	280
<b>23.</b>	<b>CHAPTER 23 SWITCH OVER .....</b>	<b>281</b>
23.1.1	Example: To Set the Switch Over Levels.....	281
23.1.2	Switch Over Parameters .....	282
<b>24.</b>	<b>CHAPTER 24 TRANSDUCER SCALING .....</b>	<b>283</b>
24.1	Auto-Tare Calibration .....	283
24.2	Transducer Summary Page.....	284
24.2.1	Tare Calibration .....	284
24.3	Strain Gauge .....	285
24.3.1	Calibration Using the Calibration Resistor Mounted in the Transducer.....	285
24.3.2	Configure Parameters for Strain Gauge Calibration.....	286
24.3.3	Configuration Examples.....	287
24.3.4	Strain Gauge Calibration.....	289
24.3.5	Calibration Using the Internal Calibration Resistor.....	289
24.4	Load Cell.....	290
24.4.1	To Calibrate a Load Cell .....	290
24.4.2	Configure Parameters.....	291
24.4.3	Configuration Examples.....	292
24.4.4	Load Cell Calibration.....	293
24.5	Comparison .....	295
24.5.1	Physical Wiring .....	295
24.5.2	Configure Parameters.....	295
24.5.3	Comparison Calibration .....	296
24.6	Transducer Scaling Parameters .....	297
24.6.1	Parameter Notes.....	298
<b>25.</b>	<b>CHAPTER 25 USER VALUES .....</b>	<b>299</b>
25.1	User Value Parameters .....	299
<b>26.</b>	<b>CHAPTER 26 CALIBRATION.....</b>	<b>300</b>
26.1	To Check Input Calibration .....	300
26.1.1	Precautions.....	300
26.1.2	To Check mV Input Calibration .....	300
26.1.3	To Check Thermocouple Input Calibration.....	301
26.1.4	To Check RTD Input Calibration .....	301
26.2	Input Calibration .....	302
26.3	Precautions.....	302
26.3.1	To Calibrate mV Range .....	302
26.3.2	To Save the New Calibration Data.....	303
26.3.3	To Return to Factory Calibration.....	303
26.3.4	Thermocouple Calibration .....	304
26.3.5	RTD Calibration .....	305
26.4	Calibration Parameters.....	306
26.5	Valve Position Output Calibration.....	307
26.6	DC Output and Retransmission Calibration .....	308
<b>27.</b>	<b>CHAPTER 27 CONFIGURATION USING ITOOLS .....</b>	<b>309</b>
27.1	Features.....	309
27.2	On-Line/Off-line Editing .....	309
27.3	Connecting a PC to the Controller.....	310
27.4	To Scan for Connected Instruments.....	310
27.5	Parameter Set Up.....	311
27.6	Device Panel .....	312
27.7	User Pages Editor .....	313
27.7.1	To Create a User Page .....	314
27.7.2	Style Examples .....	315
27.7.3	Immediate Programmer Setpoint .....	317
27.8	Recipe Editor .....	318
27.8.1	To Set Up a Recipe.....	318
27.8.2	Recipe Menu Commands.....	319
27.8.3	Watch Recipe.....	319
27.9	To Set up Alarms.....	320
27.9.1	Example: To Customise Analogue Alarm Messages .....	320
27.9.2	Alarm Summary Page.....	321
27.9.3	To Customise Digital Alarm Messages .....	322

27.10	Graphical Wiring Editor.....	323
27.10.1	Graphical Wiring Toolbar.....	323
27.10.2	Terminology.....	324
27.10.3	Using Function Blocks.....	324
27.10.4	Tooltips.....	325
27.10.5	Series 3000 Instruments.....	326
27.10.6	Using Wires.....	327
27.10.7	Using Comments.....	328
27.10.8	Using Monitors.....	329
27.10.9	Downloading To Series 3000 Instruments.....	329
27.10.10	Selections.....	329
27.10.11	Colours.....	330
27.11	Diagram Context Menu.....	330
27.11.1	Other Examples of Graphical Wiring.....	331
27.12	Program Editor.....	334
27.12.1	Analog View.....	334
27.12.2	The Spreadsheet.....	335
27.12.3	Event Outputs.....	335
27.12.4	Menu Entries and Tool Buttons.....	335
27.12.5	The Context Menu.....	335
27.12.6	Naming Programs.....	336
27.12.7	Entering a Program.....	336
27.12.8	Making Changes to a Program.....	336
27.12.9	Saving Programs.....	336
27.12.10	Moving Programs Around.....	336
27.12.11	Printing a Program.....	336
27.12.12	To Copy a Program.....	337
27.12.13	To Copy a Segment of a Program.....	337
27.12.14	To Name a User Value.....	337
27.13	Cloning.....	338
27.13.1	Save to File.....	338
27.13.2	To Clone a New Controller.....	338
27.13.3	To Clone Directly from One Controller to Another.....	338
27.14	Clone of Comms Port Settings.....	339
27.15	User Text.....	339
27.16	To Enable User Text.....	340
27.17	Loop Naming.....	341
27.18	Example 1: To Configure Lgc2 Operator 1.....	342
27.18.1	Example 2: Configure User Text Block 1.....	342
27.19	To Name a User Switch.....	343
27.20	Master Communications Configuration Example.....	344
<b>28.</b>	<b>CHAPTER 28 OEM SECURITY.....</b>	<b>349</b>
28.1	Introduction.....	349
28.2	Using OEM Security.....	349
28.3	Step 1 – View iTools OPC Server.....	350
28.4	Step 2 – Create Custom Tags.....	351
28.5	Step 3 – Activate OEM Security.....	353
28.6	Step 4 – Deactivate OEM Security.....	354
28.7	Erasing Memory.....	354
<b>29.</b>	<b>CHAPTER 29 USER SWITCHES.....</b>	<b>355</b>
29.1	User Switch Parameters.....	355
29.2	To Configure User Switches.....	355
<b>30.</b>	<b>CHAPTER 30 MODBUS SCADA TABLE.....</b>	<b>356</b>
30.1	Comms Table.....	356
30.2	SCADA Addresses.....	356
30.3	SCADA Table and Profibus Tag Addresses.....	357
30.4	Dual Programmers via SCADA Comms and Profibus Tag Addresses.....	372
30.4.1	Parameter Tables.....	372
30.4.2	Example Programmer 1/2 Setup Parameters.....	373
30.4.3	Programmer Segment Address Assignment.....	374
30.4.4	Parameters Available in Every Segment of a Programmer.....	376
30.4.5	Example: Programmer 1/2 Segment 1 Parameters.....	376
30.5	Synchronous Programmers.....	377
30.6	Asynchronous Programmers.....	378

<b>31. CHAPTER 31 EI-BISYNCH PARAMETERS.....</b>	<b>379</b>
31.1.1 (SW) Status Word .....	381
31.1.2 (OS) Optional Status word .....	381
31.1.3 (XS) Extended Status Word .....	382
31.1.4 Digital Output Status Word1 (01) .....	382
31.1.5 Digital Output Status Word2 (02) .....	382
31.1.6 Digital Output Status Word1 (03) .....	383
31.1.7 Digital Output Status Word2 (04) .....	383
31.1.8 Digital Output Status Word1 (05) .....	383
31.1.9 Digital Output Status Word2 (06) .....	383
31.1.10 Additional mnemonics, typically from 2400.....	384
<b>32. APPENDIX A SAFETY AND EMC INFORMATION.....</b>	<b>387</b>
32.1 GENERAL.....	387
32.2 Service and repair .....	387
32.3 Installation Safety Requirements.....	388
32.4 Installation requirements for EMC .....	389
<b>33. APPENDIX B TECHNICAL SPECIFICATION .....</b>	<b>390</b>
<b>34. APPENDIX C PARAMETER INDEX .....</b>	<b>397</b>

## Associated Documents

HA030143	Installation and Operation Guide (supplied with the controller)
HA025464	EMC Booklet
HA026230	Digital Communications Handbook
HA026290	Profibus Communications Handbook
HA027506	Devicenet Communications Handbook
HA026893	IO Expander
HA028838	iTools Help Manual



**Note:** These handbooks may be downloaded from [www.eurotherm.co.uk](http://www.eurotherm.co.uk).  
Whenever the symbol ☺ appears in this handbook it indicates a helpful hint.

## Issue Status of this Handbook

**Issue 3.0** of this manual applies to software version 1.2.

**Issue 4** of this manual applies to software version 2

The following enhancements now include:-

- Second control loop
- Dual programmer with the facility to synchronise the two programmers at the start or at every segment
- Programmer enhancements including PV events, guaranteed soak, timed event, wait segments, Go Back segments, PID set selector, analogue output values, 500 segments
- SCADA set up for programmer
- Quick Start changes and Quick Start code
- Configurable Modbus SCADA table
- EI Bisynch compatibility with 818, and 900 series controllers
- Default custom page templates
- Two point calibration on fixed and analogue input modules
- Multi input function block
- Summary screens for loop1/loop2/both loops/programmer. Parameter promotion to summary screen.

**Issue 5** applies to software versions 2.30+ and includes:-

Dual Analogue Output module, Profibus D type connector option, 'ImmSP?' parameter added to the Options list, User Text and Loop Naming.

**Issue 6** also applies to software versions 2.30+ and includes:-

Changes to Technical Specification Electromagnetic compatibility section when Devicenet module fitted

Addition of calibration check to Chapter 26

Improved descriptions of Strain Gauge Calibration Chapter 24

Improved descriptions of autotuning and parameters in PID Chapter 21

**Issue 7** applies to firmware versions 2.60+ and includes:-

Addition of Chapter 28 OEM Security.

Correction to Cal State parameter, section 10.3.9. – 'Repeat for minimum' should read 'Repeat for maximum'.

**Issue 8** applies to firmware version 2.70+ and includes new function block - User Switches, High Resolution Retransmission module and additional parameters (Cycle time, Wdog Flag, Wdog Action, Wdog Timeout, Wdog Recy, Servo to PV, Manual Startup).

**Issue 9** applies to firmware version 2.80+ with the following changes. Add more Zirconia block parameters. Clarify wording of Power Feedback in Diagnostics section 6.7. Correct Fahrenheit ranges section 7.2.1. Add Calibration procedure for DC outputs.

**Issue 10** applies to firmware version 2.90+ includes new sections Modbus Master Communications, section 14.9; Packbit and Unpackbit section 14.10; Master Communications Configuration Example in iTools, section 27.20; Cycle Time and Minimum On Time parameters section 8.2.2; changes to Broadcast Communications, section 14.8; additional description of 'ImmSP?', section 6.4; additional description of Nudge Raise/lower, section 21.8.9.

**Issue 11 makes the following changes:**

Section 1.3. Dual 4-20mA/TxPSU added to order code. Dual triac codes changed from \_VT to \_VH and \_VR to \_VC.

Section 14.3.2.1. Changes to final paragraph.

Section 16.1.1. Corrections to connections for humidity control

Section 16.5. Power supply removed from connection diagram and a note added.

Technical Specification. Correct calibration resistor value in Transducer Power Supply module to 30.1KΩ.

Section 18.4.2. improved description of Fallback.

**Issue 12 makes the following changes:**

Section 27.20. Change the wording in the note to say the master comms block is disabled when in configuration mode and not needs to be disabled.

Section 35. Update Declaration of Conformity.

**Issue 13** applies to firmware version 3.30. Parameter 'Tune RG2' is added to the Tune list; program cycles increased to 9999; counter direction alterable in L3. Issue 13 also includes a further description of Profibus in section 14.

**Issue 14** adds further description of Profibus and changes to Modbus address list to include tag addresses, and adds the following warning on battery life.

**Issue 15** corrects the output rate limit from seconds to minutes and clarifies upscale and downscale fallback

**Issue 16** changes NEMA4 to NEMA12

**Issue 17** adds a note to section 19.1.1 and a description of the Access drop down in section 27.7



**Warning: Back up Battery.**

This instrument is fitted with a battery designed to retain configuration and other settings in the event of a failure of the instrument power supply.

This battery has an expected life of 10 years minimum at a nominal ambient working temperature (e.g. 25°C).

The battery life may be reduced if it is consistently operated in an elevated ambient temperature environment.

**Maintenance Schedule**

A battery failure is only evident following a failure of the instrument power supply.

The battery should be replaced at regular intervals. Between 6 and 10 years is recommended depending on usage and operating temperature. The battery is not user serviceable, contact your local service centre to make suitable arrangements.

On older instruments contact your supplier to have the battery replaced prior to failure.

The age of the instrument is shown on the side label. This contains a serial number, where the last four characters either show the week number and year of manufacture WW YY, or a date in the format UK YYWW.

**It is important to maintain a record of instrument configurations or use Eurotherm iTools to make clone copies of fully working instruments. This is described in section 27.13. Store this securely as a back up to be used to restore the configuration.**

# 1. Chapter 1 Installation and Operation

## 1.1 What Instrument Do I Have?

Thank you for choosing this Controller.

The 3508 controller is supplied in the standard 1/8 DIN size (48 x 96mm front panel). The 3504 controller is supplied in the standard ¼ DIN size (96 x 96mm front panel). They are intended for indoor use only and for permanent installation in an electrical panel which encloses the rear housing, terminals and wiring on the back. They are designed to control industrial and laboratory processes via input sensors which measure the process variables and output actuators which adjust the process conditions.

### 1.1.1 Contents of Package

When unpacking your controller please check that the following items have been included.

#### 1.1.1.1 3508 or 3504 Controller Mounted in its Sleeve

The 3504 contains up to six plug-in hardware modules; the 3508 has up to three. Additionally digital communications modules can be fitted in two positions.

The modules provide an interface to a wide range of plant devices and those fitted are identified by an ordering code printed on a label fixed to the side of the instrument. Check this against the description of the code given in section 1.2 to ensure that you have the correct modules for your application. This code also defines the basic functionality of the instrument which may be:-

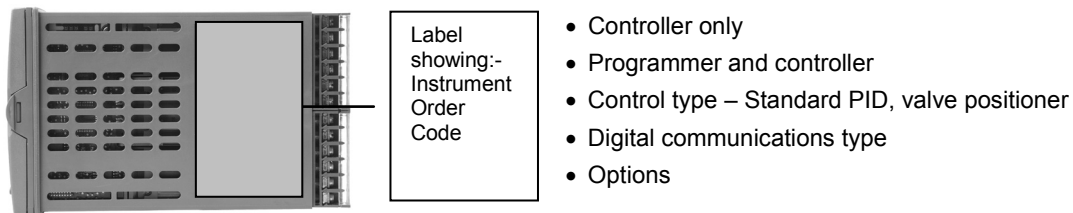

#### 1.1.1.2 Panel Retaining Clips

Two clips are required to secure the instrument sleeve in the panel. These are supplied fitted to the sleeve.

#### 1.1.1.3 Accessories Pack

For each input a 2.49Ω resistor is supplied for mA measurement. This will need to be fitted across the respective input terminals

#### 1.1.1.4 User Guide

Issue 6 of the guide applies to instrument software versions, V2.3+, and explains:-

- How to install the controller
- Physical wiring to the plant devices
- First switch on - 'out of the box'.
- Principle of operation using the front panel buttons
- Introduction to configuration through iTools PC software
- Ethernet adaptor if Ethernet communications has been ordered

### 1.1.2 Orderable Accessories

The following accessories may be ordered:-

User Manual This may also be downloaded from <a href="http://www.eurotherm.co.uk">www.eurotherm.co.uk</a>	HA027988
2.49Ω Precision resistor	SUB35/ACCESS/249R.1
Configuration IR Clip	ITools/None/30000IR
Configuration Clip	ITools/None/30000CK
10In,10Out IO Expander	2000IO/VL/10LR/XXXX
20In,20Out IO Expander	2000IO/VL/10LR/10LR

## 1.2 3504 and 3508 Ordering Code

The controller may have been ordered in accordance with the hardware code listed below. Alternatively, it may have been ordered by quoting the 'Quick Code' listed in section 1.3. If ordered to the quick code the controller will be configured in the factory. If it is not ordered using the quick code then it will be necessary to configure the controller when it is first switched on. This is described in Chapter 2.

### Hardware Coding

Model Number	Function	Supply Voltage	Number of Loops	Application	Programs	Recipes	Toolkits	Fascia

Model Number		Supply Voltage		Programs		Toolkit Wires	
3504	3504 Standard	VH	100-230Vac	X	No programs	XXX	Std 30 wires
3508	3508 Standard	VL	20-29Vac/dc	1	1 prog 20 segments	60	60 wires
				10	10 prog 500 segments	120	120 wires
				25	25 prog 500 segments	250	250 wires
				50	50 prog 500 segments		

Function		Loops	
CC	Standard	1	One loop
F	Profibus	2	Two loops

Application		Recipes	
XX	Standard	X	No recipe
ZC	Zirconia	1	1 recipe
VP	Dual Valve Position (1)	4	4 recipes
		8	8 recipes

Fascia	
G	Eurotherm green
S	Silver

(1) Provides Valve Position option in Heat/Cool applications. Single channel VP included as standard.

### Example (order code)

3504/CC/VH/2/XX/50/X/S/R2/D4/AM/XX/XX/XX/A2/XX/XX/ENG/ENG/XXXXX/XXXXX

This code describes a two loop 3504 with 50 programs. Additional modules for dual relay, analogue control, analogue input and EIA232 communications. English language and manuals with silver fascia.

### 1.2.1 Input and Output Modules

I/O Slot 1	I/O Slot 2	I/O Slot 3	I/O Slot 4 (2)	I/O Slot 5 (2)	I/O Slot 6 (2)	H Comms Slot	J Comms Slot	Config Tools	Product Language	Manuals Language	Warranty	Calibration Certificate

IO Slots 1, 2, 3, 4 (2), 5 (2), 6 (2)	
XX	None fitted
R4	Change over relay
R2	2 pin relay
RR	Dual relay
T2	Triac
TT	Dual triac
D4	DC control
DO	Dual DC output 4-20mA OP/24Vdc. Slots 1, 2 and 4 only
AM	Analogue input (not slot 2 or 5)
D6	DC retransmission
TL	Triple logic input
TK	Triple contact input
TP	Triple logic output
VU	Potentiometer input
MS	24Vdc transmitter PSU
G3	Transducer PSU 5 or 10Vdc
HR	High resolution DC retrans & 24Vdc Slots 1, 2 and 4 only
LO	Isolated single logic output

H Comms Slot	
XX	Not Fitted
A2	232 Modbus
Y2	2-wire 485 Modbus
F2	4-wire 485 Modbus
AE	232 EI-Bisynch
YE	2-wire 485 EI-Bisynch
FE	4-wire 485 EI-Bisynch
M1	232 Modbus Master
M2	2-wire 485 Modbus master
M3	4-wire 485 Modbus master
ET	Ethernet 10base
PB	Profibus (3)
PD	Profibus with D type connector (3)
DN	Devicenet

J Comms Slot	
XX	Not Fitted
A2	232 Modbus
Y2	2-wire 485 Modbus
F2	4-wire 485 Modbus
AE	4-wire 485 Modbus
YE	232 EI-Bisynch
FE	2-wire 485 EI-Bisynch
M1	4-wire 485 EI-Bisynch
M2	232 Modbus Master
M3	2-wire 485 Modbus Amaster
EX	4-wire 485 Modbus Amaster

Manuals Language	
ENG	English
FRA	French
GER	German
SPA	Spanish
ITA	Italian
XXX	None

Warranty	
XXXXX	Standard
WL005	Extended 5 year

Calibration Certificate	
XXXXX	None
CERT1	Cert of conformity
CERT2	Factory calibration certificate

Config Tools	
XX	None
IT	Standard iTools (CD only)

Product Language	
ENG	English
FRA	French
GER	German
SPA	Spanish
ITA	Italian

Custom Labels	
F1234	Special No.
XXXXX	None

Non Standard Option	
EU1234	Special No.
EC1234	Custom curve
EE1234	Custom config.
ES1234	Custom software

- (2). I/O slots 4, 5 and 6 are only available on the 3504
- (3). Only available with the Profibus Controller. No other comms module may be fitted.

### 1.3 Configuration Code (Quick Start Code)

#### Loop 1

Config	Loop 1 Units	Loop 1 Function	Loop 1 PV	Loop 1 Range Lo	Loop 1 Range Hi

Config	
STD	Standard config (1)
CFG	Factory configured

Loop 1 units	
C	Centigrade
F	Fahrenheit
%	Percent
H	%RH
P	PSI
B	Bar
M	mBar
X	None

Loop 1 Function	
PX	Single Chan. PID
FX	Single Chan. VP with Feedback
VX	Single Chan. VP without Feedback
NX	Single Chan. On/Off
PP	Dual Chan. PID
PN	Dual Chan. PID/OnOff
FF	Dual Chan. VP with Feedback
VV	Dual Chan. VP without Feedback
PF	Dual Chan. PID/VP with Feedback
PV	Dual Chan. PID/VP without feedback

Loop 1 PV	
X	Unconfigured
J	J Thermocouple
K	K Thermocouple
T	T Thermocouple
L	L Thermocouple
N	N Thermocouple
R	R Thermocouple
S	S Thermocouple
B	B Thermocouple
P	Platinell II
C	C Thermocouple
Z	Pt 100
A	4-20mA Linear
Y	0-20mA Linear
W	0-5Vdc Linear
G	1-5Vdc Linear
V	0-10Vdc Linear
Q	Custom Curve

Loop 1 Range Low	
XXXXX	Enter value with decimal point

Loop 1 Range High	
XXXXX	Enter value with decimal point

If standard config is selected an instrument without configuration will be supplied.

#### Loop 2

Loop 2 Units	Loop 2 Function	Loop 2 PV	Loop 2 Range Lo	Loop 2 Range Hi

Loop 2 Units	
C	Centigrade (2)
F	Fahrenheit (2)
%	Percent
H	%RH
P	PSI
B	Bar
M	mBar
X	None

Loop 2 Function	
XX	Single Loop Only
PX	Single Chan. PID
FX	Single Chan. VP with Feedback
VX	Single Chan. VP without Feedback
NX	Single Chan. On/Off
PP	Dual Chan. PID
PN	Dual Chan. PID/OnOff
FF	Dual Chan. VP with Feedback
VV	Dual Chan. VP without Feedback
PF	Dual Chan. PID/VP with Feedback
PV	Dual Chan. PID/VP without

Loop 2 PV	
X	Unconfigured
J	J Thermocouple
K	K Thermocouple
T	T Thermocouple
L	L Thermocouple
N	N Thermocouple
R	R Thermocouple
S	S Thermocouple
B	B Thermocouple
P	Platinell II
C	C Thermocouple
Z	Pt 100
A	4-20mA Linear
Y	0-20mA Linear
W	0-5Vdc Linear
G	1-5Vdc Linear
V	0-10Vdc Linear
Q	Custom Curve

Loop 2 Range Low	
XXXXX	Enter value with decimal point

Loop 2 Range High	
XXXXX	Enter value with decimal point

(2). If C or F units are selected they must be the same for both loops.  
If C or F are not selected for Loop 1 they cannot be selected for Loop 2

**Alarms and Input/Outputs**

Alarm 1	Alarm 2	Alarm 3	Alarm 4	Logic LA	Logic LB	Relay AA	I/O Slot 1	I/O Slot 2	I/O Slot 3	I/O Slot 4 (3)	I/O Slot 5 (3)	I/O Slot 6 (3)

Alarm 1		Alarm 3		Logic LA		Logic LB		Relay AA	
XXX	Unconfigured	XXX	Unconfigured	XX	Unconfigured	XX	Unconfigured	XX	Unconfigured
1__	Loop 1	1__	Loop 1	1_	Loop 1	1_	Loop 1	1_	Loop 1
2__	Loop 2	2__	Loop 2	2_	Loop 2	2_	Loop 2	2_	Loop 2
_FH	Full scale high	_FH	Full scale high	_B	Sensor Break	_B	Sensor Break	_H	Control Ch1 OP
_FL	Full scale low	_FL	Full scale low	_M	Manual Select	_M	Manual Select	_C	Control Ch2 OP
_DH	Deviation high	_DH	Deviation high	_H	Control Ch1 OP	_H	Ch1 OP	_B	Sensor Break
_DL	Deviation low	_DL	Deviation low	_C	Control Ch2 OP	_C	Ch2 OP	SB	Sensor Break (any loop)
_DB	Deviation band	_DB	Deviation band	_R	Remote SP	_R	Remote SP	A_	Alarm
				_S	Setpoint 2 Enable	_S	Setpoint 2 Enable	_A	Any Alarm Active
				A_	Alarm	A_	Alarm	_N	New Alarm Active
				_A	Acknowledge All Alarms	_A	Acknowledge All Alarms	_1	Alarm 1 OP
				_1	Alarm 1 OP	_1	Alarm 1 OP	_2	Alarm 2 OP
				_2	Alarm 2 OP	_2	Alarm 2 OP	P_	Programmer
				P_	Programmer	P_	Programmer	_1	Prg Event 1
				_R	Run	_R	Run	_2	Prg Event 2
				_H	Hold	_H	Hold		
				_A	Reset	_A	Reset		
				_1	Prg Ch1 Event 1	_1	Prg Event 1		
				_2	Prg Ch1 Event 2	_2	Prg Event 2		

(3). I/O slots 4, 5 and 6 are only available on the 3504.

Slot Functions 1 – 6 CH1 = Heat, CH2 = Cool

XXX	Unconfigured	HHX	Ch1 OP for loops 1 & 2	<b>Potentiometer Input *</b>		<b>Triple Logic OP</b>	
1__	Loop 1	CCX	Ch2 OP for loops 1 & 2	_RS	Remote SP	---	Select function below for each channel
2__	Loop 2	SBR	Sensor Break both loops	_VF	VP Feedback Ch1	X	Unconfigured
<b>Changeover Relay</b>		<b>Dual Triac</b>		_VG	VP Feedback Ch2	F	Loop 1 Ch1 OP
_HX	Control Ch1 OP	_HC	Ch1 OP & Ch2	<b>Triple Logic Input</b>		G	Loop 1 Ch2 OP
_CX	Control Ch2 OP	_VH	VP Ch1	---	Select function below for each channel	K	Loop 2 Ch1 OP
_BX	Sensor Break	_VC	VP Ch2	X	Unconfigured	L	Loop 2 Control Ch2 OP
<b>2-Pin Relay</b>		P12	Prg Ch1 Event 1 & 2	M	Loop 1 Manual	A	Alarm 1 OP
_HX	Control Ch1 OP	P34	Prg Ch1 Event 3 & 3	N	Loop 2 Manual	B	Alarm 2 OP
_CX	Control Ch2 OP	P56	Prg Ch1 Event 5 & 6	Q	Loop 1 Remote SP	C	Alarm 3 OP
_BX	Sensor Break	P78	Prg Ch1 Event 7 & 8	V	Loop 2 Remote SP	D	Alarm 4 OP
<b>Single Logic</b>		A12	Alarm 1 & 2 OP	S	Loop 1 Setpoint 2	1	Program Event 1
_HX	Control Ch1 OP	A34	Alarm 3 & 4 OP	T	Loop 2 Setpoint 2	2	Program Event 2
_CX	Control Ch2 OP	HHX	Ch1 OP for loops 1 & 2	E	Acknowledge All Alarms	3	Program Event 3
<b>Single Triac</b>		CCX	Ch2 OP for loops 1 & 2	P	Program Run	4	Program Event 4
_HX	Control Ch1 OP	<b>DC Control</b>		R	Program Reset	5	Program Event 5
_CX	Control Ch2 OP	_H_	Ch1 OP	H	Program Hold	6	Program Event 6
<b>Dual Relay</b>		_C_	Ch2 OP	<b>Dual 4-20mA/TxPSU</b>		7	Program Event 7
_HC	Ch1 OP & Ch2	<b>DC Retransmission *</b>		_HC	Ch1 OP (heat) & Ch2 OP (cool)	8	Program Event 8
_VT	VP Ch1	_T_	PV Retransmission	_HT	Ch1 OP (heat) loop 1, TxPSU		
_VR	VP Ch2	_S_	SP Retransmission	HHX	Ch1 OP (heat) loops 1 & 2		
P12	Prg Event 1 & 2	<b>Analogue Input *</b>		TTX	Both channels TxPSU		
P34	Prg Event 3 & 3	2PV	Loop 2 PV				
P56	Prg Event 5 & 6	_R_	Remote SP				
P78	Prg Event 7 & 8						
A12	Alarm 1 & 2 OP						
A34	Alarm 3 & 4 OP						

\* For range, select from Table 1 below

Table 1	
A	4-20mA Linear
Y	0-20mA Linear
W	0-5Vdc Linear
G	1-5Vdc Linear
V	0-10Vdc Linear

### 1.4 How to Install the Controller

This instrument is intended for permanent installation, for indoor use only, and to be enclosed in an electrical panel.

Select a location where minimum vibrations are present and the ambient temperature is within 0 and 50°C (32 and 122°F).

The instrument can be mounted on a panel up to 15mm thick.

To assure IP65 and NEMA 12 front protection, use a panel with smooth surface texture.

Please read the safety information, at the end of this guide, before proceeding and refer to the EMC Booklet part number HA025464 for further information. This and other relevant manuals may be downloaded from [www.eurotherm.co.uk](http://www.eurotherm.co.uk).

#### 1.4.1 Dimensions

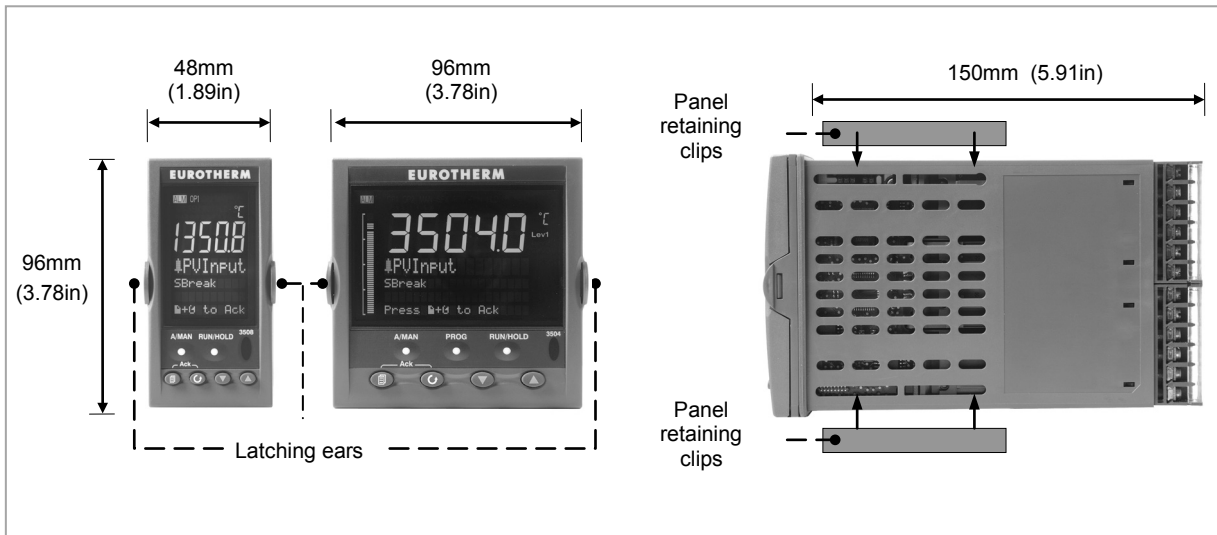

Figure 1-1: Controller Dimensions

## 1.4.2 To Install the Controller

### 1.4.2.1 Panel Cut-out

1. Prepare the panel cut-out to the size shown in the diagram
2. Insert the controller through the cut-out.
3. Spring the panel retaining clips into place. Secure the controller in position by holding it level and pushing both retaining clips forward.
4. Peel off the protective cover from the display

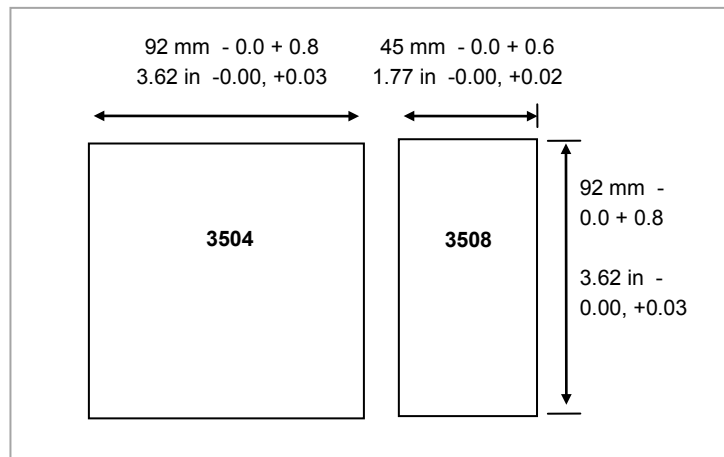

Figure 1-2: Panel Cut out Dimensions

### 1.4.2.2 Recommended Minimum Spacing

The recommended minimum spacing between controllers shown here should not be reduced to allow sufficient natural air flow

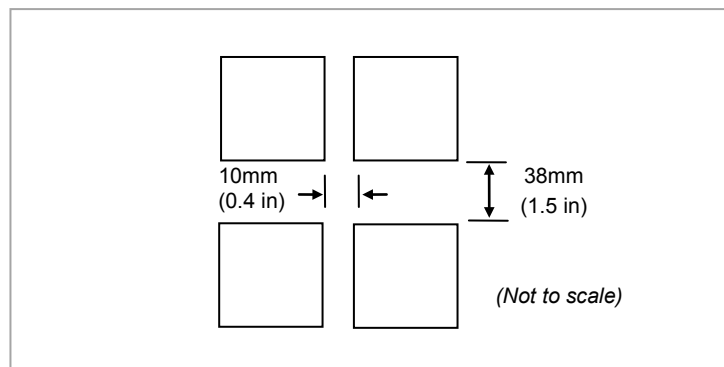

Figure 1-3: Minimum Spacing Between Controllers

### 1.4.3 Unplugging the Controller

The controller can be unplugged from its sleeve by easing the latching ears outwards and pulling it forward out of the sleeve. When plugging it back into its sleeve, ensure that the latching ears click back into place to maintain the IP65 sealing.

1.5 Electrical Connections

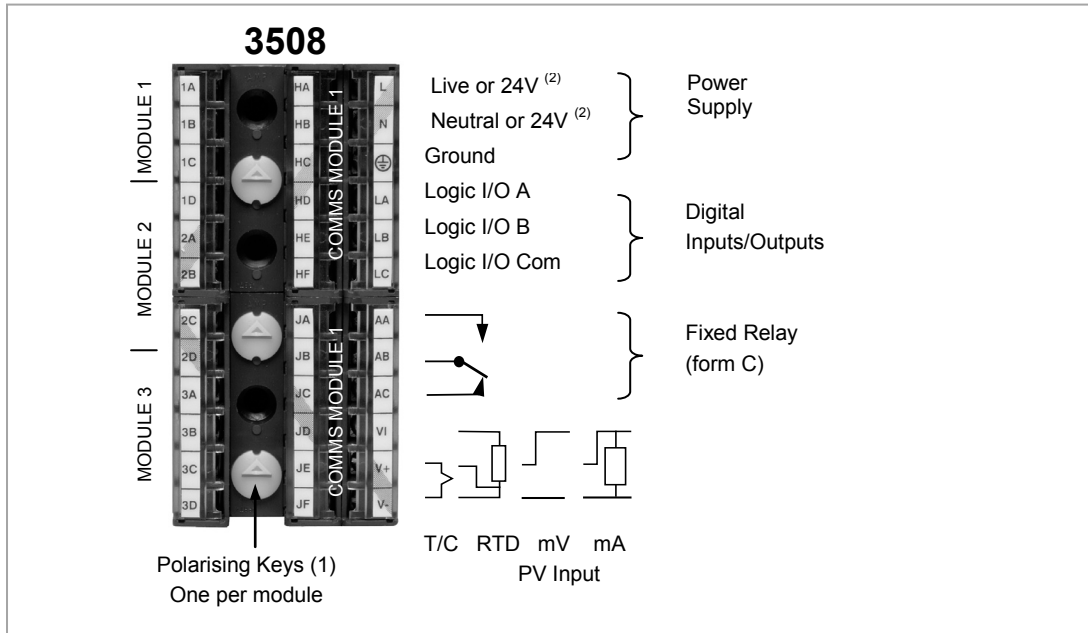

Figure 1-4: Rear Terminal View – 3508 Controller

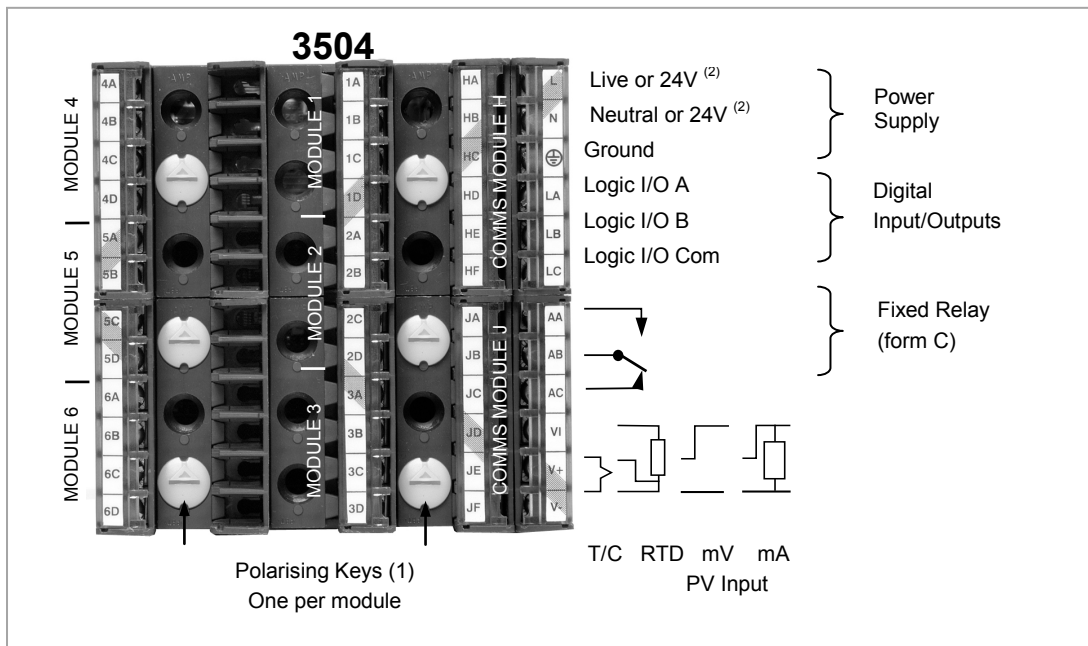

Figure 1-5: Rear Terminal View – 3504 Controller

(1) Polarising keys are intended to prevent modules which are not supported in this controller from being fitted into the controller. An example might be an unisolated module (coloured red) from a 2400 controller series. When pointing towards the top, as shown, the key prevents a controller, fitted with an unsupported module, from being plugged into a sleeve which has been previously wired for isolated modules. If an unisolated module is to be fitted, it is the users responsibility to ensure that it is safe to install the controller in the particular application. When this has been verified the polarising key may be adjusted with a screwdriver to point in the down direction.

(2) High or low voltage versions are orderable. Ensure you have the correct version

1.5.1 Wire Sizes

The screw terminals accept wire sizes from 0.5 to 1.5 mm (16 to 22AWG). Hinged covers prevent hands or metal making accidental contact with live wires. The rear terminal screws should be tightened to 0.4Nm (3.5lb in).



## 1.6 Standard Connections

These are connections which are common to all instruments in the range.

### 1.6.1 PV Input (Measuring Input)



- Caution:**
1. Do not run input wires together with power cables
  2. When shielded cable is used, it should be grounded at one point only
  3. Any external components (such as zener barriers, etc) connected between sensor and input terminals may cause errors in measurement due to excessive and/or un-balanced line resistance or possible leakage currents
  4. Not isolated from logic I/O A and logic I/O B

#### 1.6.1.1 Thermocouple or Pyrometer Input

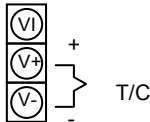

- Use the correct type of thermocouple compensating cable, preferably shielded, to extend wiring
- It is not recommended to connect two or more instruments to one thermocouple

#### 1.6.1.2 RTD Input

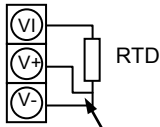

For 2-wire this is a local link

- The resistance of the three wires must be the same
- The line resistance may cause errors if it is greater than  $22\Omega$



**Note:** the RTD wiring is not the same as 2400 series instruments. It is the same as 26/2700 series

#### 1.6.1.3 Linear Input V, mV and High Impedance V

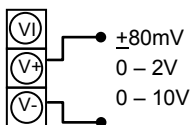

- mV range  $\pm 40\text{mV}$  or  $\pm 80\text{mV}$
- High level range 0 – 10V
- High Impedance mid level range 0 – 2V
- A line resistance for voltage inputs may cause measurement errors

#### 1.6.1.4 Linear Input mA

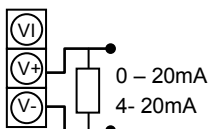

- Connect the supplied load resistor equal to  $2.49\Omega$  for mA input  
The resistor supplied is 1% accuracy 50ppm  
A resistor 0.1% accuracy 15ppm resistor can be ordered as a separate item

**1.6.2 Digital I/O**

These terminals may be configured as logic inputs, contact inputs or logic outputs in any combination. It is possible to have one input and one output on either channel.

**X Warning:** The Digital IO is not isolated from the PV input.

**1.6.2.1 Logic Inputs**

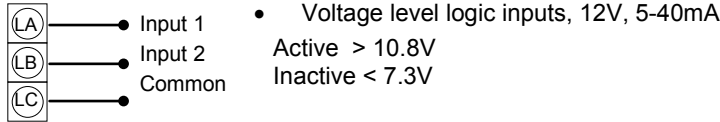

**1.6.2.2 Contact Closure Inputs**

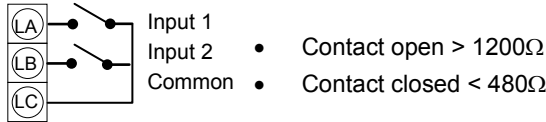

**1.6.3 Digital (Logic) Outputs**

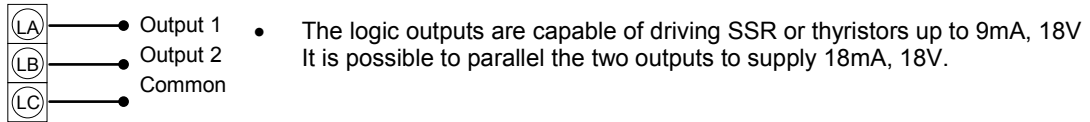

**X Warning:** The Digital IO terminals are not isolated from the PV.

The fixed digital logic outputs may be used to power remote 2 wire transmitters. The fixed digital I/O are, however, not isolated from the PV input circuit, so this does not allow the use of 3 or 4 wire transmitters. An isolated module must be used for the 3 and 4 wire types.

**1.6.4 Digital (Logic) Outputs used to power a remote 2 wire transmitter.**

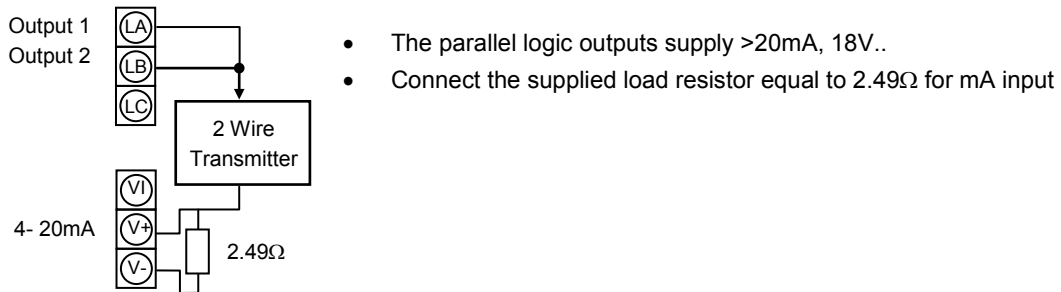

**X Warning:** The Digital IO terminals are not isolated from the PV.

**1.6.5 Digital (Logic) Outputs used to power a remote 3 wire transmitter.**

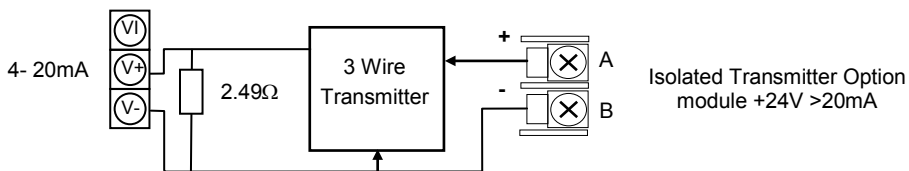

**1.6.6 Digital (Logic) Outputs used to power a remote 4 wire transmitter.**

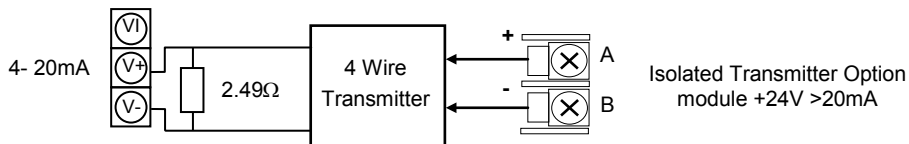

### 1.6.7 Relay Output

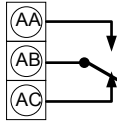

- Relay rating, min: 1V, 1mAdc. Max: 264Vac 2A resistive
- Relay shown in de-energised state
- Isolated output 240Vac CATII

#### 1.6.7.1 General Note About Inductive Loads

High voltage transients may occur when switching inductive loads such as some contactors or solenoid valves.

For this type of load it is recommended that a 'snubber' is connected across the contact of the relay switching the load. The snubber typically consists of a 15nF capacitor connected in series with a 100Ω resistor and will also prolong the life of the relay contacts.



**Warning:** When the relay contact is open and it is connected to a load, the snubber passes a current (typically 0.6mA at 110Vac and 1.2mA at 240Vac. It is the responsibility of the installer to ensure that this current does not hold on the power to an electrical load. If the load is of this type the snubber should not be connected.

See also section 1.8.9.

### 1.6.8 Power Supply Connections

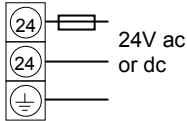
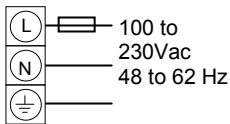

1. Before connecting the instrument to the power line, make sure that the line voltage corresponds to the description on the identification label
2. For supply connections use 16AWG or larger wires rated for at least 75°C
3. Use copper conductors only
4. For 24V the polarity is not important
5. It is the Users responsibility to provide an external fuse or circuit breaker.  
For 24 V ac/dc fuse type T rated 4A 250V  
For 100/240Vac fuse type T rated 1A 250V

Safety requirements for permanently connected equipment state:

- a switch or circuit breaker shall be included in the building installation
- it shall be in close proximity to the equipment and within easy reach of the operator
- it shall be marked as the disconnecting device for the equipment



**Note:** A single switch or circuit breaker can supply more than one instrument

### 1.7 Plug in I/O Module Connections

Plug in I/O modules can be fitted in three positions in the 3508 and six positions in 3504. The positions are marked Module 1, 2, 3, 4, 5, 6. With the exception of the Analogue Input module, any other module listed in this section, can be fitted in any of these positions. To find out which modules are fitted check the ordering code printed on a label on the side of the instrument. If modules have been added, removed or changed it is recommended that this is recorded on the instrument code label.

The function of the connections varies depending on the type of module fitted in each position and this is shown below. All modules are isolated.



**Note:** The order code and terminal number is pre-fixed by the module number. For example, Module 1 is connected to terminals 1A, 1B, 1C, 1D; module 2 to 2A, 2B, 2C, 2D, etc.

#### 1.7.1 Relay (2 pin) and Dual Relay Module

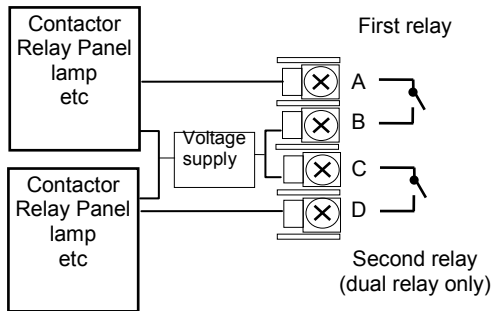

- Hardware Code: R2 and RR
- Relays Rating: 2A, 264Vac max or 1mA, 1V min
- Typical usage: Heating, cooling, alarm, program event, valve raise, valve lower
- Isolated output 240Vac CATII

#### 1.7.2 Change Over Relay

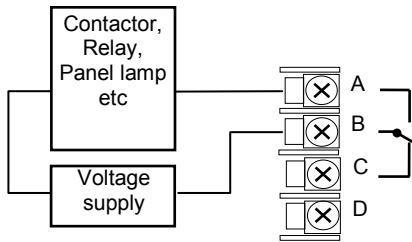

- Hardware Code: R4
- Relay Rating: 2A, 264Vac max or 1mA, 1V min
- Typical usage: Heating, cooling, alarm, program event, valve raise, valve lower.
- Isolated output 240Vac CATII

#### 1.7.3 Triple Logic and Single Isolated Logic Output

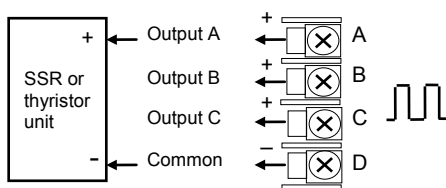

- Hardware Code: TP and LO
- Outputs Rating - Single: (12Vdc at 24mA max.)
- Outputs Rating - Triple: (12Vdc at 9mA max.)
- Typical usage: Heating, cooling, program events.
- No channel isolation. 264Vac insulation from other modules and system
- Single Logic Output connections are:-  
D – Common  
A – Logic Output

#### 1.7.4 Triac and Dual Triac

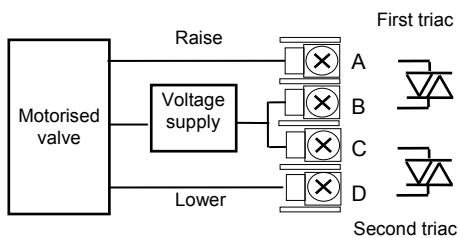

- Hardware Code: T2 and TT
- Combined Output Rating: 0.7A, 30 to 264Vac
- Typical usage: Heating, cooling, valve raise, valve lower.
- Isolated output 240Vac CATII
- Dual relay modules may be used in place of dual triac.
- **The combined current rating for the two triacs must not exceed 0.7A**

**1.7.5 DC Control**

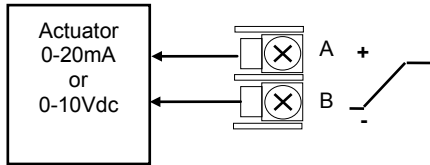

- Hardware Code: D4
- Output Rating: (10Vdc, 20mA max)
- Typical Usage: Heating, cooling e.g. to a 4-20mA process actuator
- Isolated output 240Vac CATII

**1.7.6 DC Retransmission**

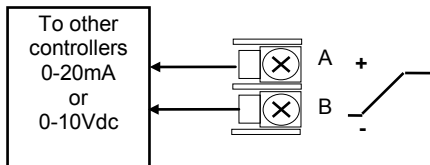

- Hardware Code: D6
- Output Rating: (10Vdc, 20mA max)
- Typical Usage: Logging of PV, SP, output power, etc., (0 to 10Vdc or 0 to 20mA)
- Isolated output 240Vac CATII

**1.7.7 Dual DC Output  
Slots 1, 2 and 4 only**

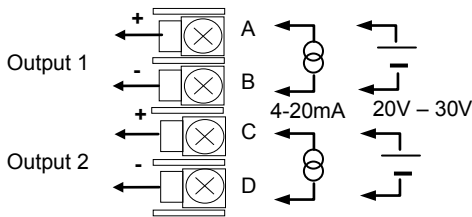

- Hardware Code: DO
- Output Rating: each channel can be 4-20mA or 24Vdc power supply)
- Typical Usage: Control output 12 bit resolution

**1.7.8 High Resolution DC Retransmission & Transmitter Power Supply  
Slots 1, 2 and 4 only**

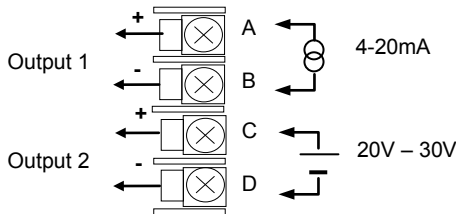

- Hardware Code: HR
- Output Rating: Channel 1 (15 bit 4-20mA). Channel 2 (24Vdc)
- Typical Usage: Retransmission Channel 1. Transmitter power supply Channel 2

**1.7.9 Triple Logic Input**

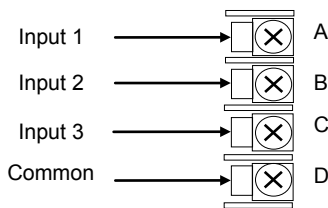

- Hardware Code: TL
- Input Ratings: Logic inputs <5V OFF >10.8V ON Limits: -3V, +30V
- Typical Usage: Events e.g. Program Run, Reset, Hold
- Isolated output 240Vac CATII

**1.7.10 Triple Contact Input**

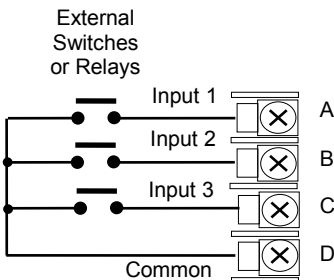

- Hardware Code: TK
- Input Ratings: Logic inputs >28KΩ OFF <100Ω ON
- Typical Usage: Events e.g. Program Run, Reset, Hold
- Isolated output 240Vac CATII

**1.7.11 24V Transmitter Supply**

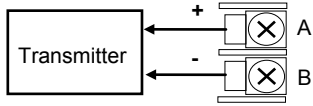

- Hardware Code: MS
- Output Rating: 24Vdc 20mA
- Typical Usage: To power an external transmitter
- Isolated output 240Vac CATII

**1.7.12 Potentiometer input**

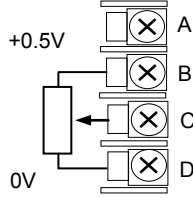

- Hardware Code: VU
- Rating: 100Ω to 15KΩ
- Typical Usage: Valve position feedback  
Remote setpoint
- Isolated output 240Vac CATII

**1.7.13 Transducer Power Supply**

**Transducer with Internal Calibration Resistor**

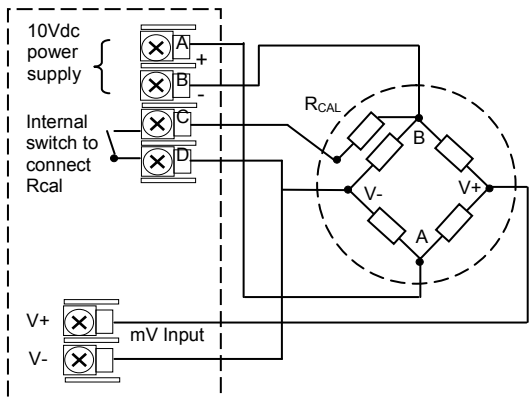

- Hardware Code: G3
- Rating: Configurable 5V or 10Vdc. Minimum load resistance 300Ω
- Typical Usage: Strain Gauge transducer power and measurement
- Isolated output 240Vac CATII

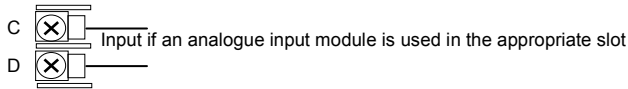

**Transducer with External Calibration Resistor**

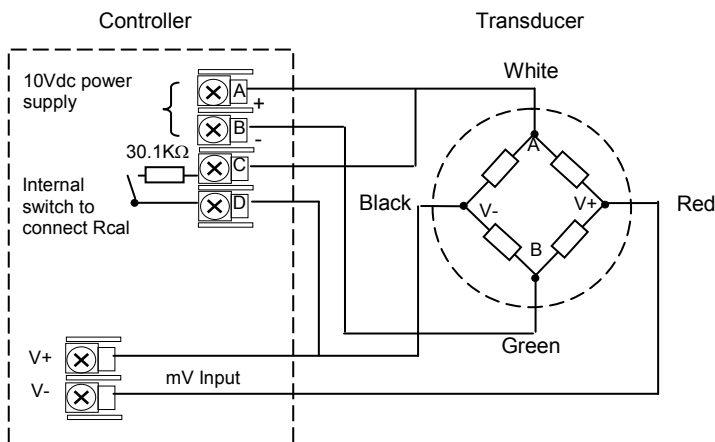

**1.7.14 Analogue Input (T/C, RTD, V, mA, mV)  
Slots 1, 3, 4 & 6 only**

- Hardware Code: AM
- Typical Usage: Second PV input, Remote setpoint
- Isolated 240Vac CATII

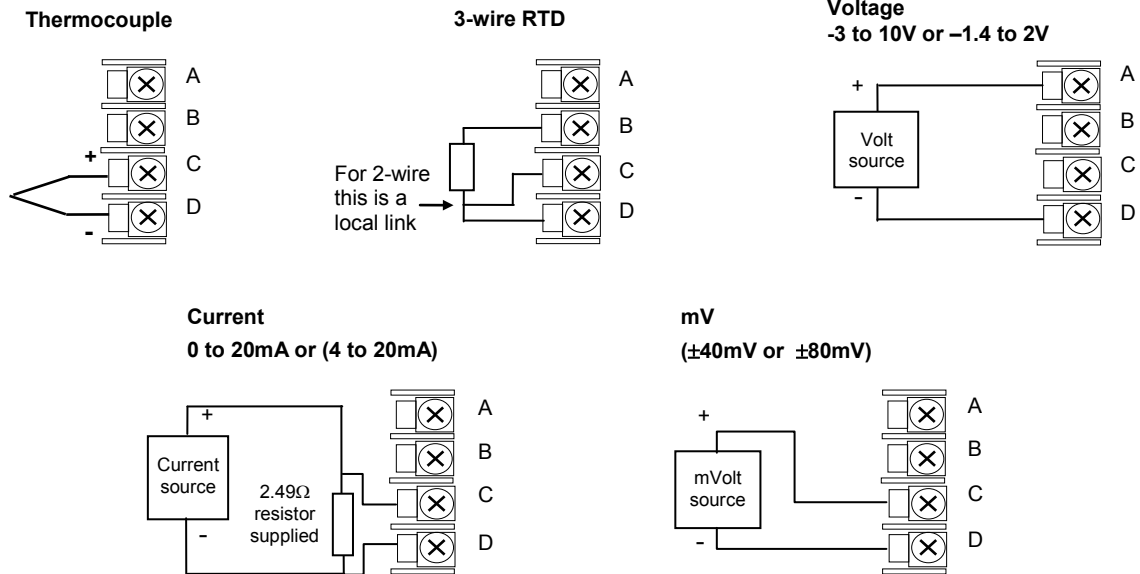

**1.7.15 Analogue Input (Zirconia Probe)**

- The temperature sensor of the zirconia probe can be connected to the Fixed PV input, terminals V+ and V-, or to an Analogue Input module, terminals C & D. The Volt Source connected to an Analogue Input module, terminals A & D.

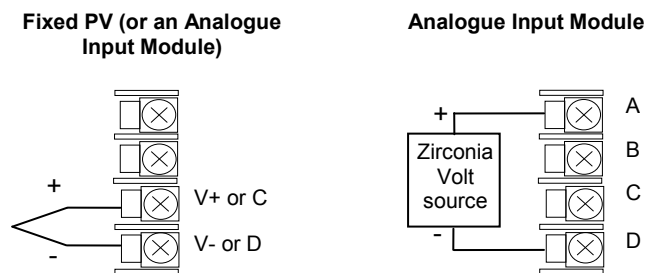

**1.7.16 Zirconia Probe Construction**

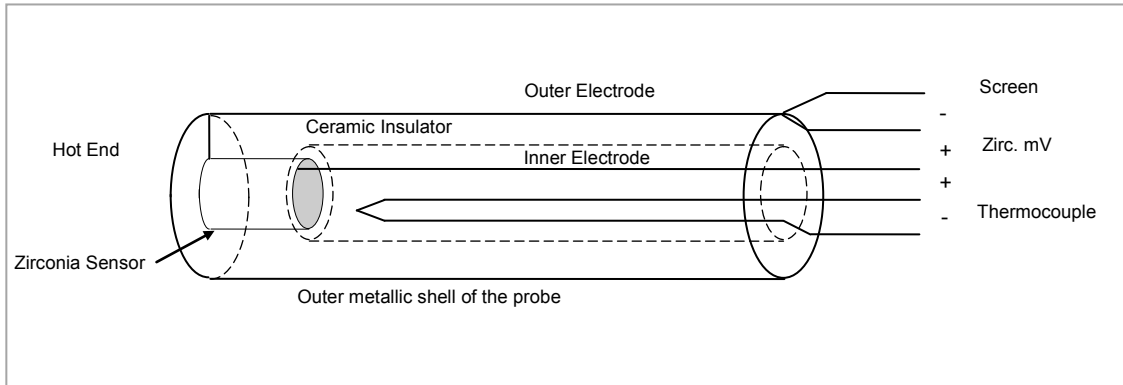

**Figure 1-6: Schematic of Zirconia Probe**

**1.7.17 Zirconia Probe Screening Connections**

The zirconia sensor wires should be screened and connected to the outer shell of the probe if it is situated in an area of high interference.

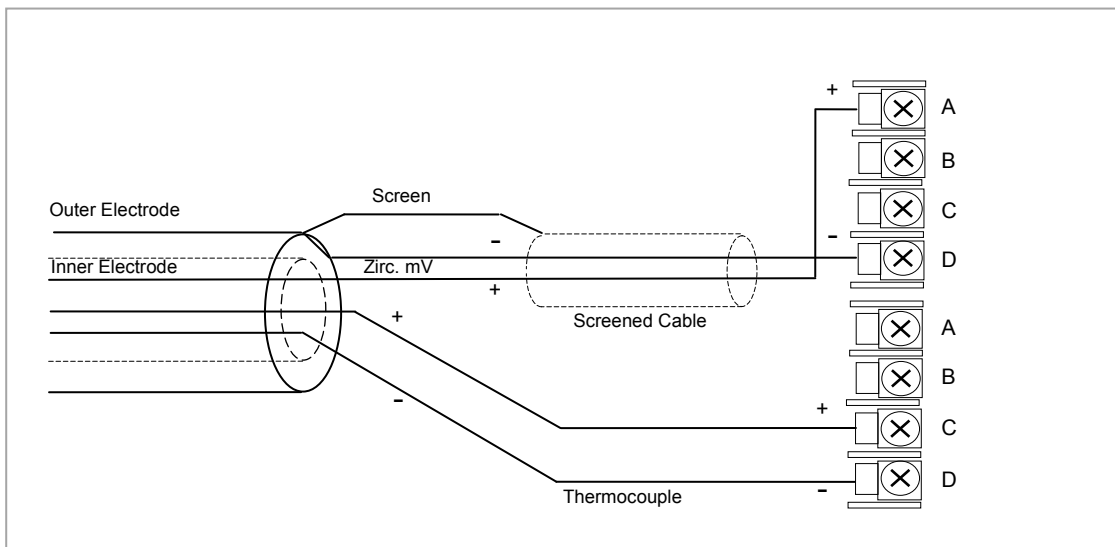

**Figure 1-7: Zirconia Probe Wiring**



### 1.8 Digital Communications Connections

Digital Communications modules can be fitted in two positions in both 3508 and 3504 controllers. The connections being available on HA to HF and JA to JF depending on the position in which the module is fitted. The two positions could be used, for example, to communicate with 'iTools' configuration package on one position, and to a PC running a supervisory package on the second position. Communications protocols may be ModBus, EIBisynch, DeviceNet, Profibus or ModBus TCP.

**Note:** In order to reduce the effects of RF interference the transmission line should be grounded at both ends of the screened cable. However, if such a course is taken care must be taken to ensure that differences in the earth potentials do not allow circulating currents to flow, as these can induce common mode signals in the data lines. Where doubt exists it is recommended that the Screen (shield) be grounded at only one section of the network as shown in all of the following diagrams

**Note:** EIA is sometimes referred to as RS (eg EIA232). 3-Wire and 5-Wire is sometimes referred to as 2-Wire and 4-Wire.

#### 1.8.1 Modbus (H or J Module), EIBisynch, Broadcast and Modbus Master

A further description of ModBus and EIBisynch communications is given in 2000 series Communications Handbook, Part No. HA026230, which can be downloaded from [www.eurotherm.co.uk](http://www.eurotherm.co.uk).

See also section 14.8.2 for further details when wiring Broadcast and Modbus Master.

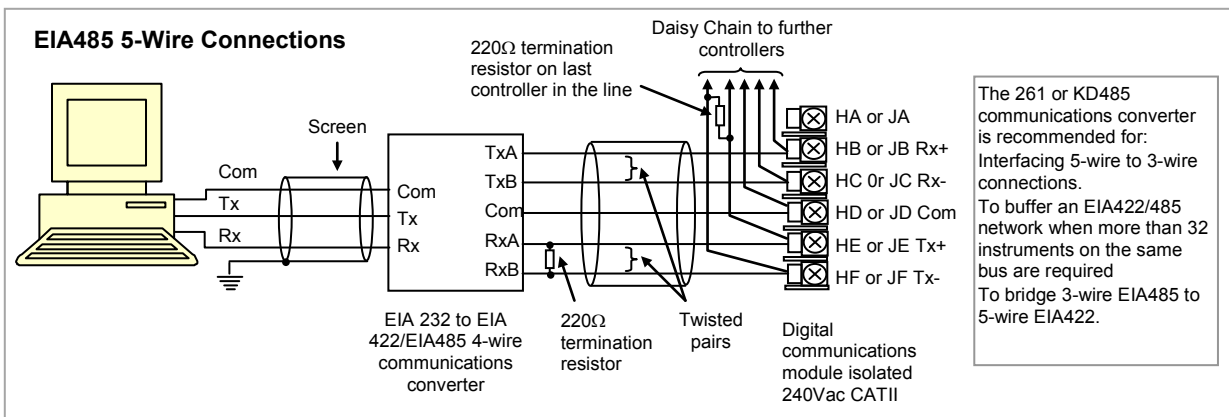
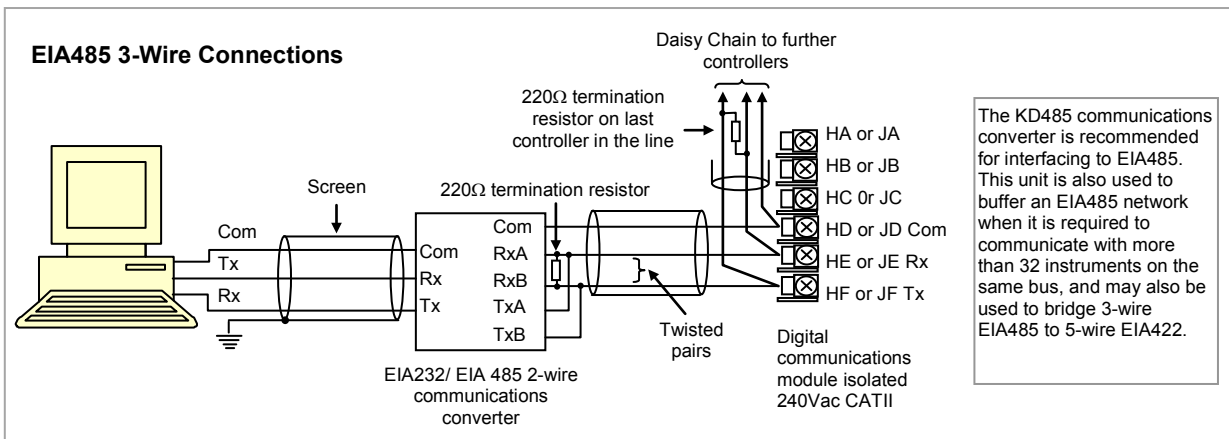
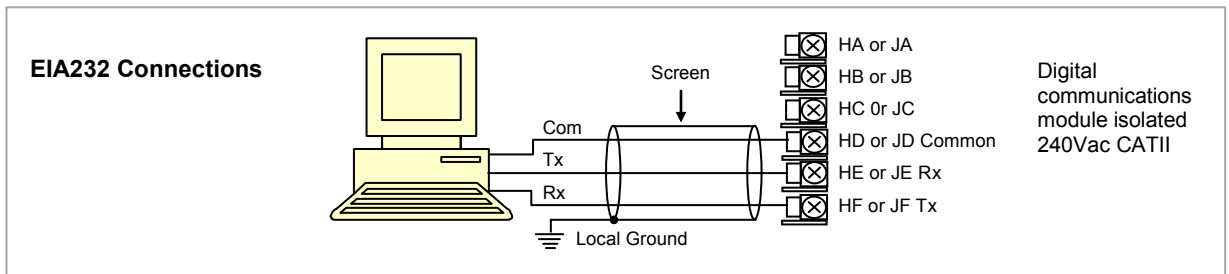

Figure 1-8: EIA232 and EIA485 Connections

**1.8.2 DeviceNet Wiring**

It is not within the scope of this manual to describe the DeviceNet standard. For this please refer to the DeviceNet specification which may be found at [www.odva.org](http://www.odva.org).

In practice it is envisaged that 3500 series controllers will be added to an existing DeviceNet network. This section, therefore, is designed to provide general guidelines to connect 3500 series controllers to this network. Further information is also available in the DeviceNet Communications Handbook Part No HA027506 which can be downloaded from [www.eurotherm.com](http://www.eurotherm.com).

According to the DeviceNet standard two types of cable may be used. These are known as Thick Trunk and Thin Trunk. For long trunk lines it is normal to use Thick trunk cable. For drop lines thin trunk cable is generally more convenient being easier to install. The table below shows the relationship between cable type, length and baud rate.

Network length	Varies with speed. Up to 400m possible with repeaters		
Baud Rate Mb/s	125	250	500
Thick trunk	500m (1,640ft)	200m (656ft)	75m (246ft)
Thin trunk	100m (328ft)	100m (328ft)	100m (328ft)

This table shows standard cable connections.

Terminal Reference	CAN Label	Color Chip	Description
HA	V+	Red	DeviceNet network power positive terminal. Connect the red wire of the DeviceNet cable here. If the DeviceNet network does not supply the power, connect to the positive terminal of an external 11-25 Vdc power supply.
HB	CAN_H	White	DeviceNet CAN_H data bus terminal. Connect the white wire of the DeviceNet cable here.
HC	SHIELD	None	Shield/Drain wire connection. Connect the DeviceNet cable shield here. To prevent ground loops, the DeviceNet network should be grounded in only one location.
HD	CAN_L	Blue	DeviceNet CAN_L data bus terminal. Connect the blue wire of the DeviceNet cable here.
HE	V-	Black	DeviceNet network power negative terminal. Connect the black wire of the DeviceNet cable here. If the DeviceNet network does not supply the power, connect to the negative terminal of an external 11-25 Vdc power supply.
HF			Connect to instrument earth

**1.8.3 Example DeviceNet Wiring Diagram**

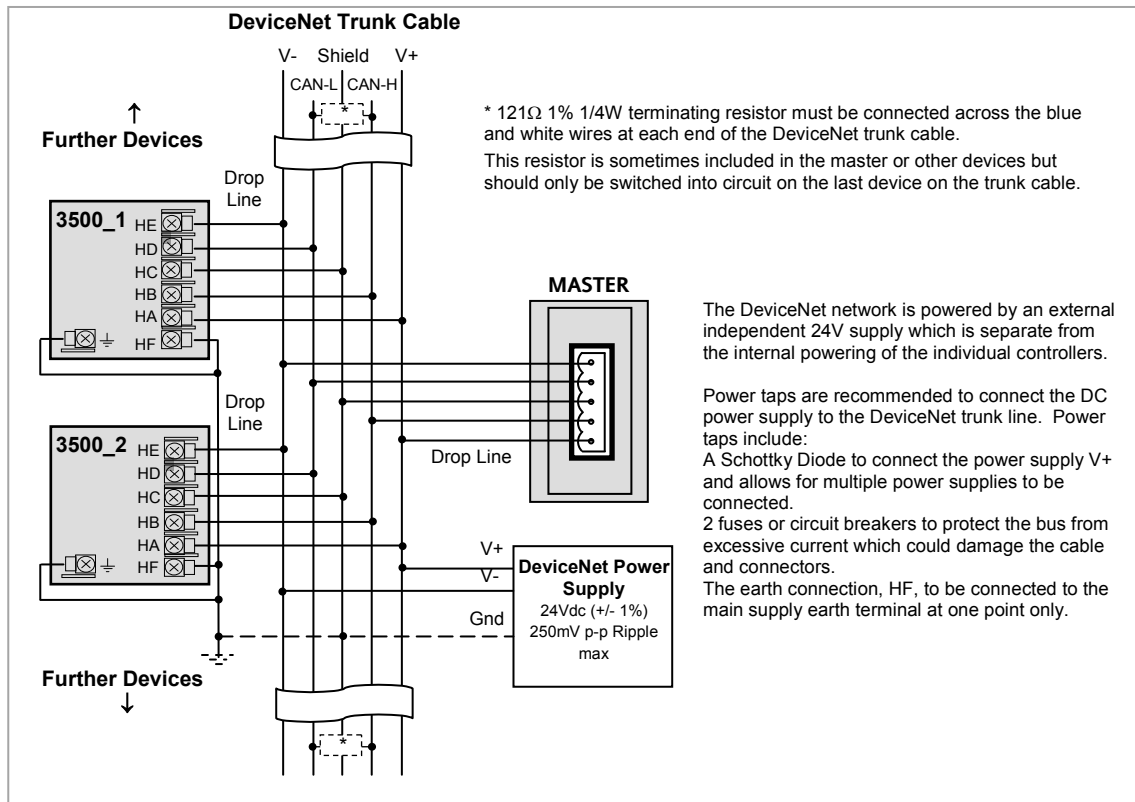

**Figure 1-9: Example of Devicenet Wiring**

**1.8.4 Profibus**

A description of Profibus is given in section 14.5. Please also refer to the Profibus Communications Handbook Part No HA026290 which can be downloaded from [www.eurotherm.co.uk](http://www.eurotherm.co.uk).

RS485 is the transmission technology used in 3500 series controllers. Controllers ordered with digital communications option PD are supplied with a D type connector fitted to terminals HB to HF as shown in Figure 1-14. Standard Profibus cables have a special 9 pin male connector which allow one or two cables to be connected into them so that 'nodes' (eg controllers or third party devices) may be daisy chained.

**1.8.4.1 Controller Terminal Connections**

Controller Terminal	D-type pin	Designation	Function
HB	1	Shield	RF Ground for cable shielding
HC	6	VP	+5Vdc Voltage connection for termination network only
HD	3	B/B	RXD/TXD positive
HE	8	A/A	RXD/TXD negative
HF	5	D Gnd	0 Volts connection for termination network only

**1.8.4.2 Example Profibus Wiring**

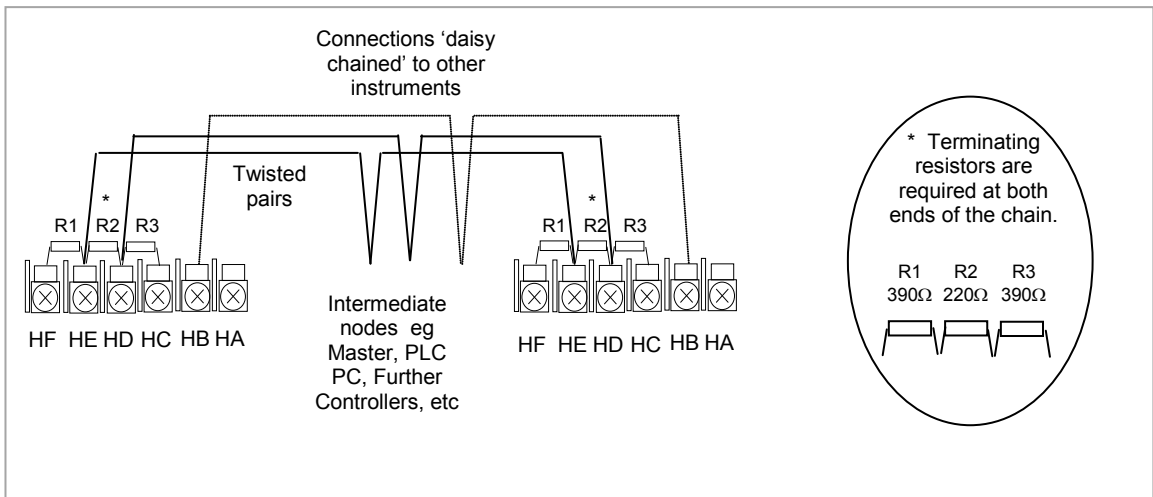

**Figure 1-10: Profibus Wiring**

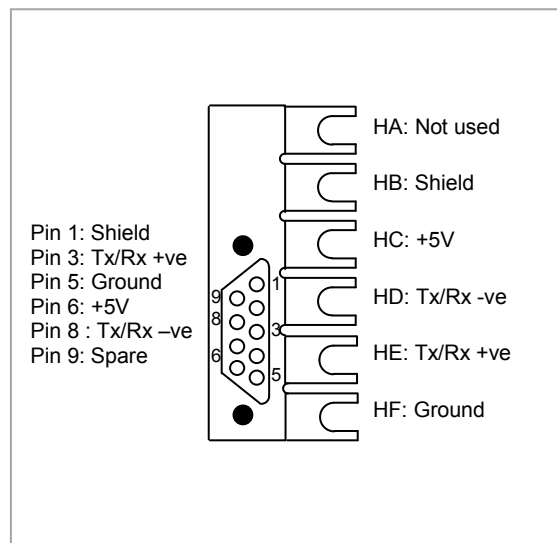
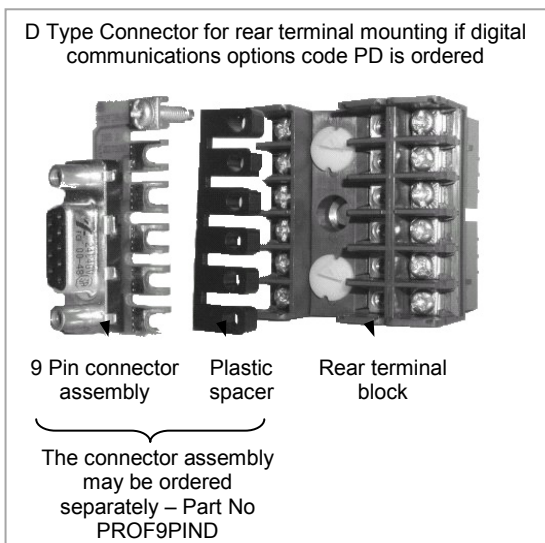

**Figure 1-11: Profibus Connector**

### 1.8.5 Ethernet (ModBus TCP)

When the controller is supplied with the Ethernet communications option a special cable assembly is also supplied. This cable must be used since the magnetic coupling is contained within the RJ45 connector. It consists of an RJ45 connector (socket) and a termination assembly which must be connected to terminals HA to HF.

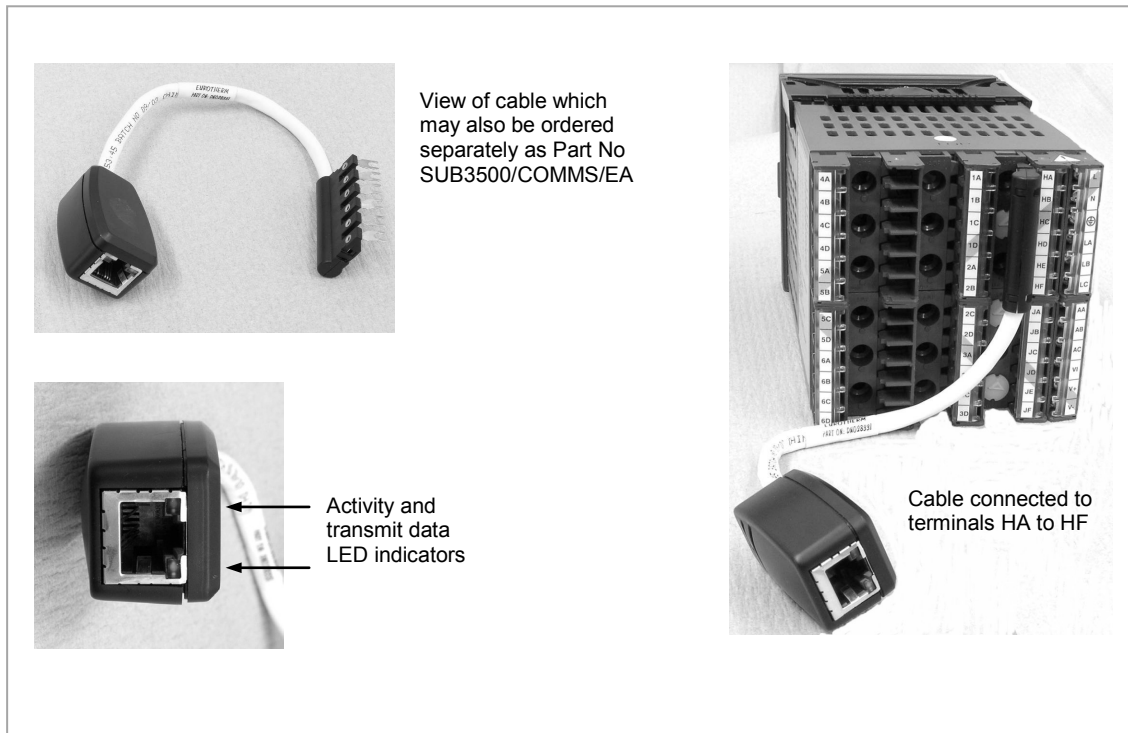
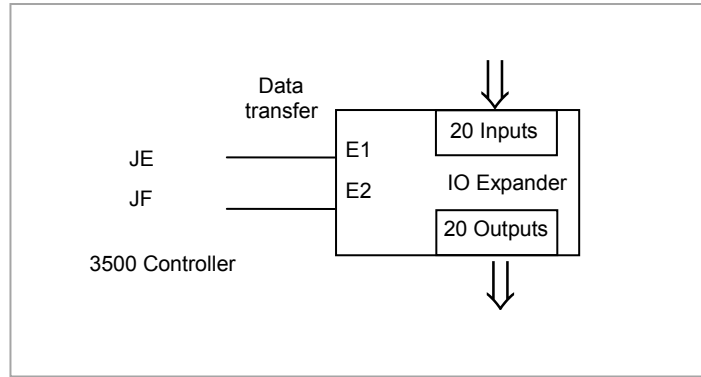

Figure 1-12: Ethernet Cable

**1.8.6 I/O Expander**

An I/O expander (Model No 2000IO) can be used with 3500 series controllers to allow the number of I/O points to be increased by up to a further 20 digital inputs and 20 digital outputs. Data transfer is performed serially via a two wire interface module which is fitted in digital communications slot J.

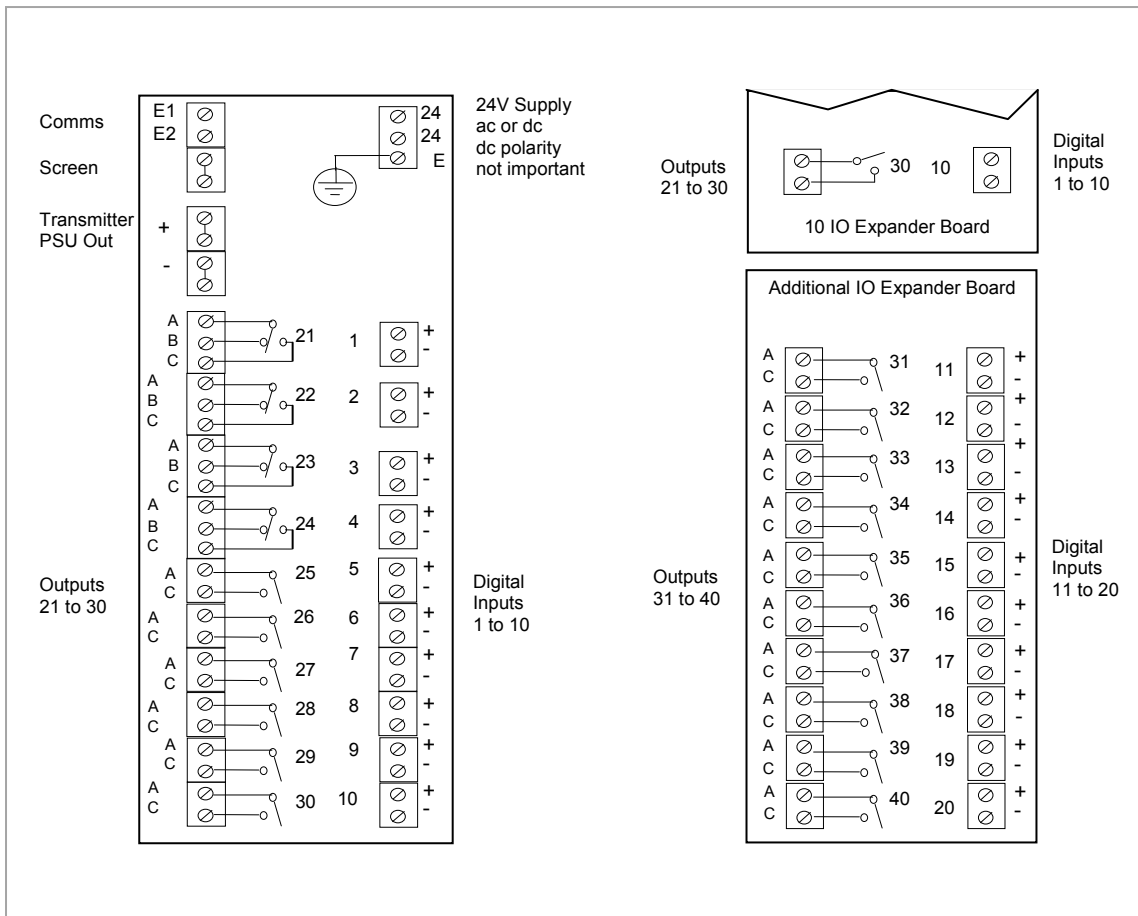

**Figure 1-13: Data Transfer Between IO Expander and Controller**

A description of the IO Expander is given in Handbook Part No HA026893 which can be downloaded from [www.eurotherm.co.uk](http://www.eurotherm.co.uk).

The connections for this unit are reproduced below for convenience.

**1.8.7 IO Expander Connections**



**Figure 1-14: IO Expander Terminals**

**1.8.8 Example Wiring Diagram**

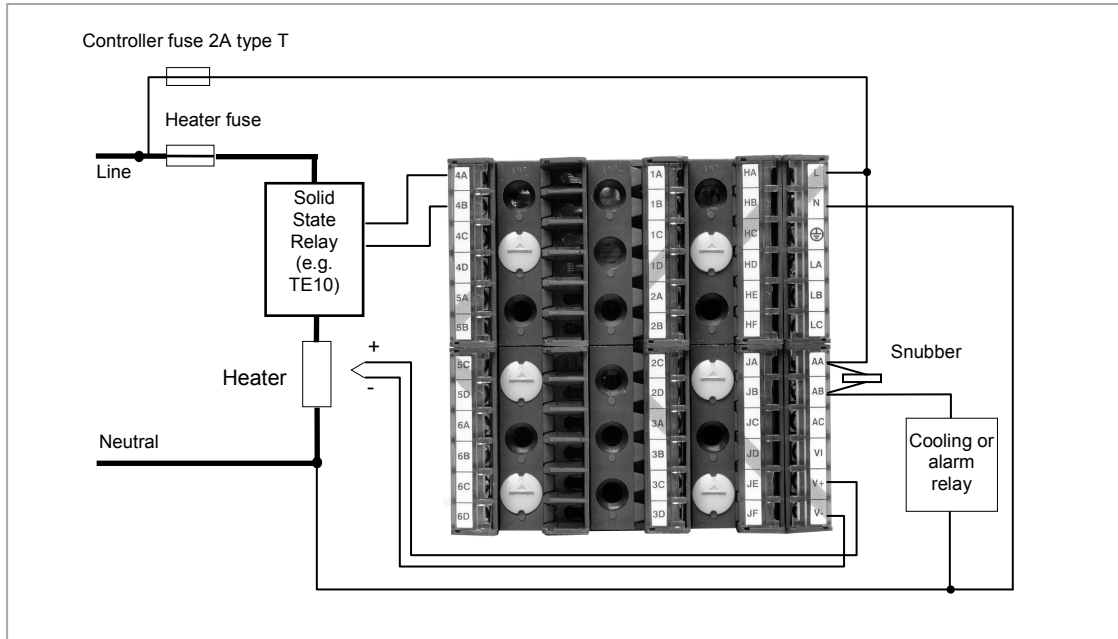

**Figure 1-15: Example Wiring Diagram**

Please refer to the EMC Electromagnetic Compatibility Handbook Part No. HA025464 for details of good wiring practice. This can be downloaded from [www.eurotherm.co.uk](http://www.eurotherm.co.uk).

**1.8.9 Snubbers**

Snubbers are used to prolong the life of relay contacts and to reduce interference when switching inductive devices such as contactors or solenoid valves. The fixed relay (terminals AA/AB/AC) is not fitted internally with a snubber and it is recommended that a snubber be fitted externally, as shown in the example wiring diagram. If the relay is used to switch a device with a high impedance input, no snubber is necessary.

All relay modules are fitted internally with a snubber since these are generally required to switch inductive devices. However, snubbers pass 0.6mA at 110V and 1.2mA at 230Vac, which may be sufficient to hold on high impedance loads. If this type of device is used it will be necessary to remove the snubber from the circuit.

The snubber is removed from the relay module as follows:-

1. Unplug the controller from its sleeve
2. Remove the relay module
3. Use a screwdriver or similar tool to snap out the track. The view below shows the tracks in a Dual Relay Output module.

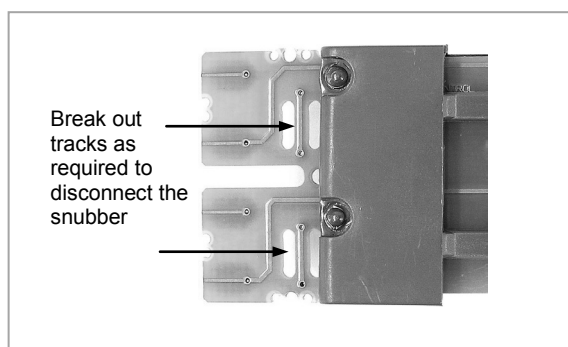

**Figure 1-16: Snubber Removal**

## 2. Chapter 2 Getting Started

A brief start up sequence consists of a self test in which all elements of the display are illuminated and the software version is shown. What happens next depends on one of two conditions:-

1. Power up out of the box – when the controller has no preset configuration and is switched on for the very first time it will start up in 'QuickStart mode. This is an intuitive tool for configuring the controller and is described in section 2.1 below.
2. The controller has been powered up previously and is already configured. In this case go to section 2.3.

### 2.1 Quick Start - New Controller (Unconfigured)

Quick Start is a tool which enables the controller to be matched to the most common processes without the need to go to full configuration level described later in this Manual.

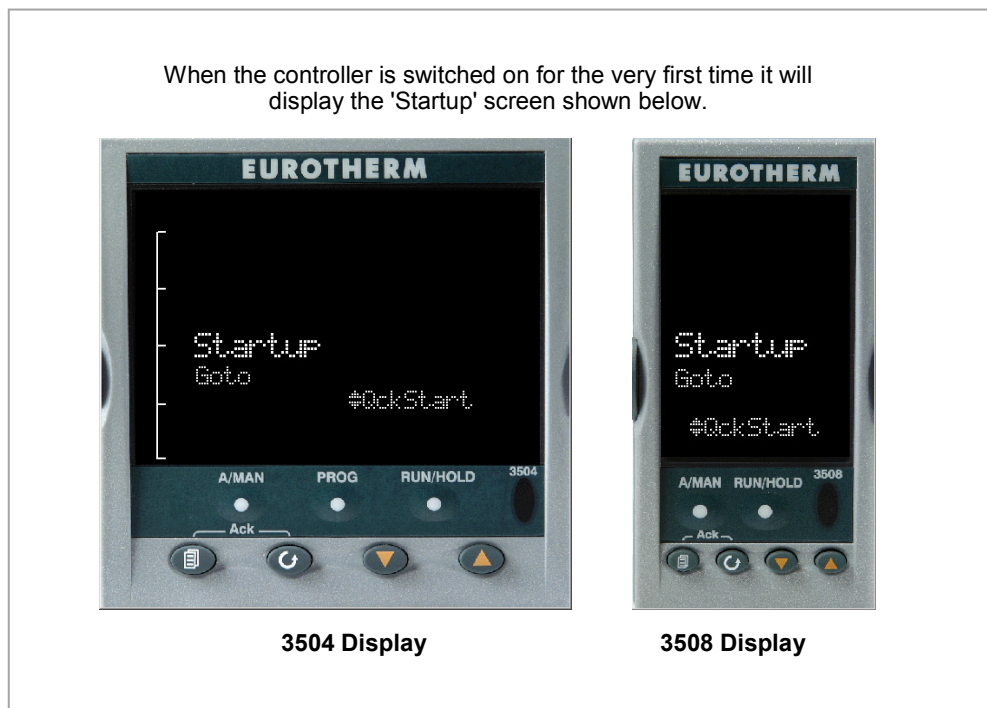



Figure 2-1: Start Up Views



Manual mode, section 2.6, is always selected when in Quick Start mode because the controller resets to cold start when Quick Start is selected.



**Warning:** Incorrect configuration can result in damage to the process and/or personal injury and must be carried out by a competent person authorised to do so. It is the responsibility of the person commissioning the controller to ensure the configuration is correct



### 2.1.1 To Configure Parameters in Quick Start Mode







With 'QckStart' selected, press  to scroll through the list of parameters

Edit the parameters using the  or  buttons









Each time  button is pressed a new parameter will be presented

This is illustrated by the following example:- (The views shown are taken from the 3504 controller).

 From the Startup view, shown in the previous section, you can press  or  to select Configuration Mode. To fully configure the controller refer to later sections of this handbook.

 Backscroll – to scroll back through parameters press and hold  then press  to go back through the list of parameters. You can also press and hold  +  to go forward - this has the same effect as pressing  alone.

#### Example

Do This	Display	Additional Notes
1. From the Start view press  2. Press  or  to change the 'Units' 3. A different parameter is selected each time  is pressed.		The first parameter to be configured is 'Units'. It resides in the 'PV Input List' because it is associated with the process variable.  When the required choice is selected a brief blink of the display indicates that it has been accepted
4. Continue setting up the parameters presented until the 'Finished' view is displayed. 5. If all parameters are set up as required press  or  to 'Yes'		If you wish to scroll around the parameters again do not select Yes but continue to press  .  When you are satisfied with the selections select 'Yes'.  The 'HOME' display - section 2.3 is then shown.

The following table summarises all the parameters which can be set up by the above procedure.

### 2.1.2 Quick Start Parameters

Parameters shown in **Bold** are defaults.

Group	Parameter	Value	Availability
LP1 PV Input	Units Used to select the engineering units for the PV. (C, F, K options also change the displayed units)	<b>C</b> , F, K V, mV, A, mA, pH, mmHg, psi, Bar, mBar, %RH, %, mmWG, inWG, inWW, Ohms, PSIG, %O2, PPM, %CO2, %CP, %/sec, mBar/Pa/T, sec, min, hrs, None	Always
LP1 PV Input	Resolution Used to select the required decimal point position for the PV	<b>XXXXX</b> , XXXX.X, XXX.XX, XX.XXX, X.XXXX	Always
LP1 PV Input	Range Type Used to select the linearisation algorithm required and the input sensor.	Thermocouple: J, <b>K</b> , L, R, B, N, T, S, PL2, C, CustC1(2&3) RTD: Pt100 Linear: 0-50mV, 0-5V, 1-5V, 0-10V, 2-10V, 0-20mA, 4-20mA	Always
LP1 PV Input	IO Type Only shown if custom curve is selected	Thermocpl, RTD, Pyrometer, mV40, mV80, mA, Volts, HIZVolts, Log10	
LP1 PV Input	Range High/Low Configures the maximum/minimum display range and SP limits	Depends on Range type selected. Default <b>1372-200</b>	Always
LP1 Loop	Control Channel 1. Sets the control type for channel 1 (normally Heat)	<b>PID</b> , VPU, VPB, Off, OnOff	Always
LP1 Loop	Control Channel 2. Sets the control type for channel 2 (normally Cool)	PID, VPU, VPB, <b>Off</b> , OnOff	Always
LP2 PV Input	Source Defines where the PV input is wired to for Loop 2.	<b>None</b> , FixedPV, Module1 (to 6). Available only if an analogue input module is fitted.	If a dual loop controller
The LP1 parameters listed above are repeated for LP2 if the LP2 PV Input is configured			



Group	Parameter	Value	Availability
Init LgcIO LA	Logic function (input or output) The LA Logic I/O port can be an output or an input. This parameter is used to select its function.	<b>Not Used</b> , Lp1 Ch1, Lp1 Ch2, Lp2 Ch1, Lp2 Ch2, Alarm 1 to 8, Any Alarm, New Alarm, ProgEvt1 to 8, LP1SBrkOP, LP2SBrkOP*, LPsSBrk*, (outputs) LP1 A-M, LP1 SPsel, LP2 A-M, LP2 SPsel, AlarmAck, ProgRun, ProgReset, ProgHold (Inputs)	[Note 1] [Note 2] * LP2 and LPs (both loops) only shown if the second loop is configured Programmer options only available if the controller is a programmer/controller
Init LgcIO LA	Min On Time This applies to both LA and LB inputs	<b>Auto</b> 0.01 to 150.00	[Note 2] [Note 3]
The above two parameters are repeated for the LB Logic I/O (LgcIO LB)			
Init RlyOP AA	Relay function This relay is always fitted.	<b>Not Used</b> , Lp1 Ch1, Lp1 Ch2, Lp2 Ch1, Lp2 Ch2, Alarm 1 to 8, Any Alarm, New Alarm, ProgEvt1 to 8, LP1SBrkOP, LP2SBrkOP*, LPsSBrk*.	Always. [Note 4] Programmer options only available if the controller is a programmer/controller)
Init RlyOP AA	Min On Time	<b>Auto</b> 0.01 to 150.00	[Note 2] [Note 3]



**Note 1:** Parameters only appear if the function has been turned on, eg If 'Control Channel 1' = 'Off', 'Chan 1' does not appear in this list. When a control channel is configured for valve positioning, LgcIO LA and LgcIO LB act as a complementary pair. If, for example, Chan 1 is connected to LgcIO LA (valve raise) then LgcIO LB is automatically set to Chan 1 (valve lower). This ensures the valve is never raised and lowered simultaneously. The same complementary behaviour also applies to dual output modules and channels A and C of triple output modules



**Note 2:** If any input function, for example Chan 1, is connected to another input it will not appear in this list



**Note 3:** Is available if the Control Channel is not On/Off and is allocated to the LA, LB or AA output as applicable



**Note 4:** For valve position control Chan 1 or Chan 2 will not appear in this list. Valve position outputs can only be dual outputs such as LA and LB or dual relay/triac output modules

**2.1.2.1 Modules**

The following parameters configure the plug in I/O modules. I/O Modules can be fitted in any available slot in the instrument (6 slots in 3504, 3 slots in 3508). The controller automatically displays parameters applicable to the module fitted - if no module is fitted in a slot then it does not appear in the list.

Each module can have up to three inputs or outputs. These are shown as A, B or C after the module number and this corresponds to the terminal numbers on the back of the instrument. If the I/O is single only A appears. If it is dual A and C appears if it is triple A, B and C appear.



**Note 1:** If a Dual DC Output module is fitted, it cannot be configured using the Quick Start Code. To configure this module refer to the User Manual part no. HA027988 which can be downloaded from [www.eurotherm.co.uk](http://www.eurotherm.co.uk).



**Note 2:** If an incorrect module is fitted the message 'Bad Ident' will be displayed.

Module type	Parameter	Value		Availability
Change over Relay (R4) 2 pin Relay (R2) Triac output (T2)	Relay (Triac) function	Not Used All parameters the same as RlyOP AA, including Min OnTime if the OP is a relay		Always (if the module is fitted)
	Dual Relay (RR) Dual Triac output (TT)	Relay (Triac) function		
Single Logic Output (LO) Triple Logic Output (TP)	Relay function			Always (if the module is fitted)
	Logic Out function	Not Used All parameters the same as RlyOP AA		
DC Output (D4) DC Retransmission (D6)	DC Output function	Not Used	Module fitted but not configured	Always (if the module is fitted)
		LP1 Ch1OP	Loop 1 Channel 1 control output	
		LP1 Ch2OP	Loop 1 Channel 2 control output	
		LP2 Ch1OP	Loop 2 Channel 1 control output	
		LP2 Ch2OP	Loop 2 Channel 2 control output	
		LP1 SP Tx	Loop 1 setpoint retransmission	
		LP1 PV Tx	Loop 1 PV retransmission	
		LP1 ErrTx	Loop 1 error retransmission	
		LP1 PwrTx	Loop 1 output retransmission	
		LP2 SP Tx	Loop 2 setpoint retransmission	
		LP2 PV Tx	Loop 2 PV retransmission	
		LP2 ErrTx	Loop 2 error retransmission	
		LP2 PwrTx	Loop 2 output retransmission	
		Range Type	0-5V, 1-5V, 1-10V, 2-10V, 0-29mA, 4-20mA	
Display High	100.0			
Display Low	0			
Triple Logic Input (TL) Triple Contact Input (TK)	Logic In function	Not Used	Module fitted but not configured	A function can only be allocated to one input. eg if AlarmAck is configured on X*A it is not offered for the other inputs * is the module number. LP2 does not appear if loop 2 is not configured.
		LP1 A-M	Loop 1 Auto/manual	
		LP1 SPsel	Loop 1 SP select	
		LP1 AltSP	Loop 1 Alternative SP select	
		LP2 A-M	Loop 2 Auto/manual	
		LP2 SPsel	Loop 2 SP select	
		LP2 AltSP	Loop 2 Alternative SP select	
		AlarmAck	Alarm acknowledge	
		ProgRun	Programmer run	
		ProgReset	Programmer reset	
		ProgHold	Programmer hold	

Module type	Parameter	Value	Availability	
Analogue Input (AM)	Analogue IP function	Not Used	Module fitted but not configured	LP1 V1Pos and LP1 V2Pos only appear if the control channel 1 or control channel 2 is set to VPB. Remote SP does not appear if the programmer option is supplied. LP2 does not appear if loop 2 is not configured.
		LP1 AltSP	Loop 1 alternative setpoint	
		LP1 OPH	Loop 1 remote OP power max	
		LP1 OPL	Loop 1 remote OP power min	
		LP2 AltSP	Loop 2 alternative setpoint	
		LP2 OPH	Loop 2 remote OP power max	
		LP2 OPL	Loop 2 remote OP power min	
		LP1 V1Pos LP1 V2Pos	To read valve position from the feedback potentiometer loop 1	
	LP2 V1Pos LP2 V2Pos	To read valve position from the feedback potentiometer loop 2		
	Range Type	Thermocouple: J, K, L, R, B, N, T, S, PL2, C. RTD: Pt100 Linear: 0-50mV, 0-5V, 1-5V, 0-10V, 2-10V, 0-20mA, 4-20mA	Not shown if analogue IP function not used	
Display High	100.0	These parameters only appear for Linear Range		
Display Low	0.0			
Potentiometer Input (VU)	Pot Input function	Not Used	Module fitted but not configured	Ch1V1vPos/Ch2V1vPos only appear if the channel = VPB Remote SP does not appear if the programmer option is supplied. LP2 does not appear if loop 2 is not configured.
		LP1 AltSP	Loop 1 Alternative setpoint	
		LP1 OPH	Loop 1 output power maximum	
		LP1 OPL	Loop 1 output power minimum	
		LP2 AltSP	Loop 2 Alternative setpoint	
		LP2 OPH	Loop 2 output power maximum	
		LP2 OPL	Loop 2 output power minimum	
		LP1 V1Pos LP1 V2Pos	To read valve position from the feedback potentiometer loop 1	
LP2 V1Pos LP2 V2Pos	To read valve position from the feedback potentiometer loop 2			
Transducer Power Supply (G3)	TdcrPSU function	5 Volts 10 Volts	Always (if the module is fitted)	
Transmitter power supply (MS)	No parameters. Used to show the ID of the module if fitted			





**2.1.2.2 Alarms**

Group	Parameter	Value		Availability
Init Alarm 1 to 8	Type	None	No alarm type configured	Always
		Abs High	Absolute high	
		Abs Low	Absolute low	
		Dev High	Deviation high	
		Dev Low	Deviation low	
		Dev Band	Deviation band	
Init Alarm 1 to 8	Source	None	Not connected	Always if Type ≠ None PV Input and ModX Ip do not appear if Type = Deviation
		PV Input	Connected to current process variable does not appear if Alarm Type = Deviation	
		LP1 PV	Connected to Loop 1 process variable	
		LP2 PV	Connected to Loop 2 process variable	
		Module1 to Module6	Connected to an analogue input module and only of the Alarm Type is not a deviation alarm	
Init Alarm 1 to 8	Setpoint	To adjust the alarm threshold within the range of the source.		Always if Type ≠ None
Init Alarm 1 to 8	Latch	None	No latching	Always if Type ≠ None
		Auto	Automatic latching see 2.7.1	
		Manual	Manual latching see section 2.7.1	
		Event	Alarm beacon does not light but any output associated with the event will activate and a scrolling message will appear.	
Finished	Exit	No	Continue back around the quick configuration list	
		Yes	Go to normal operation. The loop(s) are set to Auto on exit from quickstart mode and the controller re-starts in Level 2.	

## 2.2 To Re-enter Quick Start Mode

If you have exited from Quick Start mode (by selecting 'Yes' to the 'Finished' parameter) and you need to make further changes, the Quick start mode can be entered again at any time. The action which takes place depends on one of two previous conditions as follows:-

### 2.2.1 Power up After a Quick Start Configuration

1. Hold  down then power up the controller. Keep this button pressed until the Quick start screen as shown in section 2.1 is displayed.
2. Press  to enter the quick start list. You will then be asked to enter a passcode.
3. Use  or  to enter the passcode – default 4 – the same as the configuration level passcode. If an incorrect code is entered the display reverts to the 'Quick Start' view section 2.1.

It is then possible to repeat the quick configuration as described previously.





The Quick Start view shown in section 2.1 now contains an additional parameter - '**Cancel**'. This is now always available after a power up, and, if selected, will take you into normal operating mode, section 2.3.

### 2.2.2 Power up After a Full Configuration

Repeat 1,2 and 3 above.

Full configuration allows a greater number of parameters to be configured in a deeper level of access. This is described later in this manual.

If the controller has been re-configured in this level, a '**WARNING**' message, '**Delete config?**' - '**No**' or '**Yes**', will be displayed. If 'No' is selected the display drops back to the 'GoTo' screen.

1. Use  or  to select 'Yes'
2. Press  to confirm or  to cancel. (If no button is pressed for about 10 seconds the display returns to the WARNING message).

If 'Yes' is selected the **Quick start defaults** will be re-instated. **All** the Quick start parameters must be reset.

### 2.3 Normal Operation

Switch on the controller. Following a brief self-test sequence, the controller will start up in AUTO mode (see AUTO/MAN section 2.6) and Operator Level 2 (following Quick Start).

If the controller is configured as a dual loop instrument the start up view shows a summary of the two loops. This is called the HOME display.

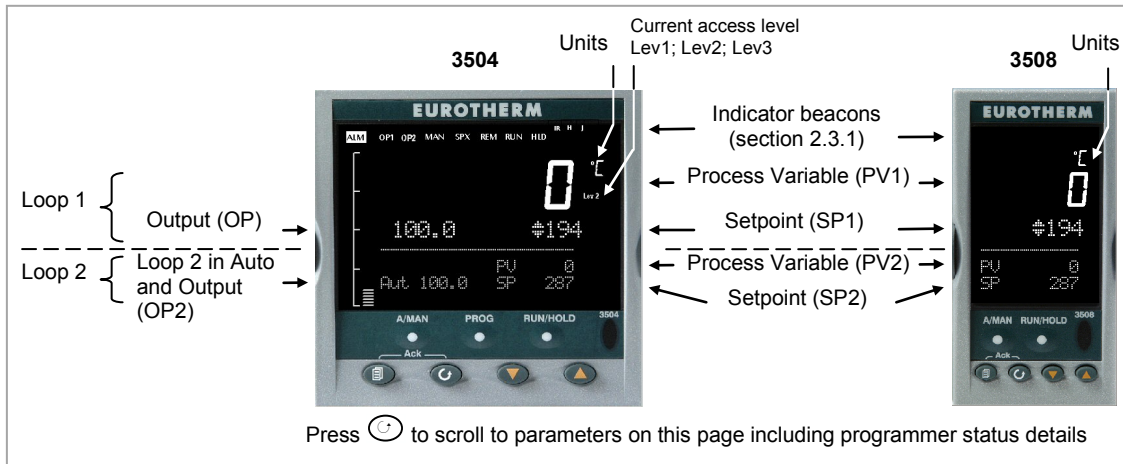

If the controller is configured as a single loop the HOME displays will vary as shown below:-

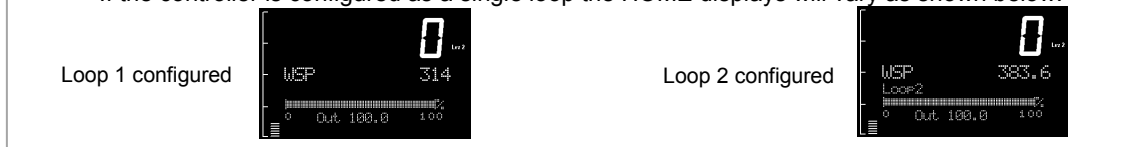

Figure 2-2: HOME Display

Other views may be configured as the HOME display and other summary displays can be selected using button. See Message Centre section 2.8.





#### 2.3.1 Beacon Display and Description



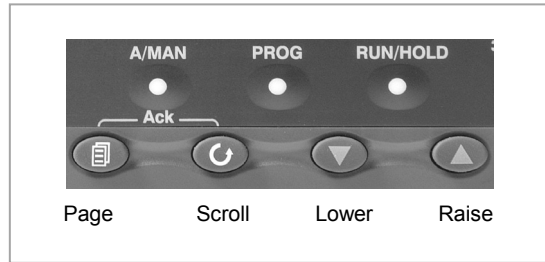

















<b>OP1 OP2</b>	In a single loop controller OP1 and OP2 operate on channel 1 and 2 outputs respectively for the configured loop. In a dual loop controller OP1 and OP2 operate on Loop 1 channel 1 and 2 outputs respectively when any 'Summary Page' (section 2.8) is displayed unless the Summary Page is Loop 2. If the Summary Page is Loop 2 then OP1 and OP2 operate on loop 2 channel outputs. These parameters may also be soft wired, see parameters 'OP1 Beacon' and 'OP2 Beacon' in 'Inst' 'Dis' table in section 6.5.
<b>MAN</b>	Illuminates when manual mode active. If the HOME display is showing the dual loop overview, MAN illuminates if Loop 1 is in manual. If the Loop 1 or Loop 2 overviews are being displayed MAN applies to the loop being displayed.
<b>REM</b>	Illuminates when remote setpoint active
<b>SPX</b>	Illuminates when alternative setpoint active
<b>ALM</b>	If an alarm occurs the red alarm beacon flashes. This is accompanied by a message showing the source of the alarm, for example 'Boiler overheating'. To acknowledge press  and . The message disappears. If the alarm condition is still present the beacon lights continuously. When cleared it will extinguish. Section 2.7 describes alarm operation.
<b>RUN</b>	Illuminates when programmer running – flashing indicates End
<b>HLD</b>	Illuminates when programmer held
<b>J</b>	Flashes when J Channel comms active
<b>H</b>	Flashes when H Channel comms active
<b>IR</b>	Flashes when infra red communications active

In general throughout this handbook instrument views will use the 3504. The displayed information is similar for the 3508 but in some cases is shortened due to display limitations.

## 2.4 The Operator Buttons



<p>A/MAN This button can be disabled</p>	<p>Toggles the selected loop between Auto and Manual operation. The action of this button is described in section 2.6.</p> <p>Manual operation means that the controller output power is adjusted by the user. The input sensor is still connected and reading the PV but the control loop is open.</p> <p>Auto means that the controller is automatically adjusting the output to maintain control, ie the loop is closed.</p> <p>If the controller is in manual mode, 'MAN' light will be indicated.</p> <p>If the controller is powered down in Manual operation it will resume this mode when it is powered up again.</p>
<p>PROG</p>	<p>To select the programmer summary page</p>
<p>RUN/HOLD This button can be disabled</p>	<p>Press once to start a program. 'RUN' will be indicated</p> <p>Press again to hold a program. 'HLD' will be indicated</p> <p>Press and hold for at least two seconds to reset a program.</p> <p>'RUN' will flash at the end of a program</p> <p>'HLD' will flash during holdback</p> <p>Programmer operation is fully described in chapter 22 of the User Manual</p>
	<p>Press to select new PAGE headings</p>
	<p>Press to select a new parameter in the page</p>
	<p>Press to decrease an analogue value, or to change the state of a digital value</p>
	<p>Press to increase an analogue value, or to change the state of a digital value</p>

Shortcut Key Presses	
<p>Backpage</p>	<p>Press  followed by . With  held down continue to press  to scroll page headers backwards. (With  still pressed you can press  to page forward. This action is the same as pressing  alone).</p>
<p>Backscroll</p>	<p>When in a list of parameters, press  followed by .</p> <p>With  held down continue to press  to scroll parameters backwards.</p> <p>(With  still pressed you can press  to page forward. This action is the same as pressing  alone).</p>
<p>Jump to the HOME display</p>	<p>Press  + </p>
<p>Alarm Ack/reset</p>	<p>Press  and  when the HOME screen is being displayed to jump to the 'Acknowledge All alarms' page. Pressing  acknowledges all alarms if it can, see section 2.7.1. Pressing  cancels the operation.</p>

## 2.5 To Set the Required Temperature (Setpoint)

A parameter value can be changed if it is preceded by  $\blacktriangleleft$ . In the example shown below this is SP1, the setpoint for loop 1.

To change the value, press  $\blacktriangledown$  or  $\blacktriangle$ . The output level shown in the HOME display will change to indicate the source of the setpoint while either of the buttons is pressed, in this example SP 1.

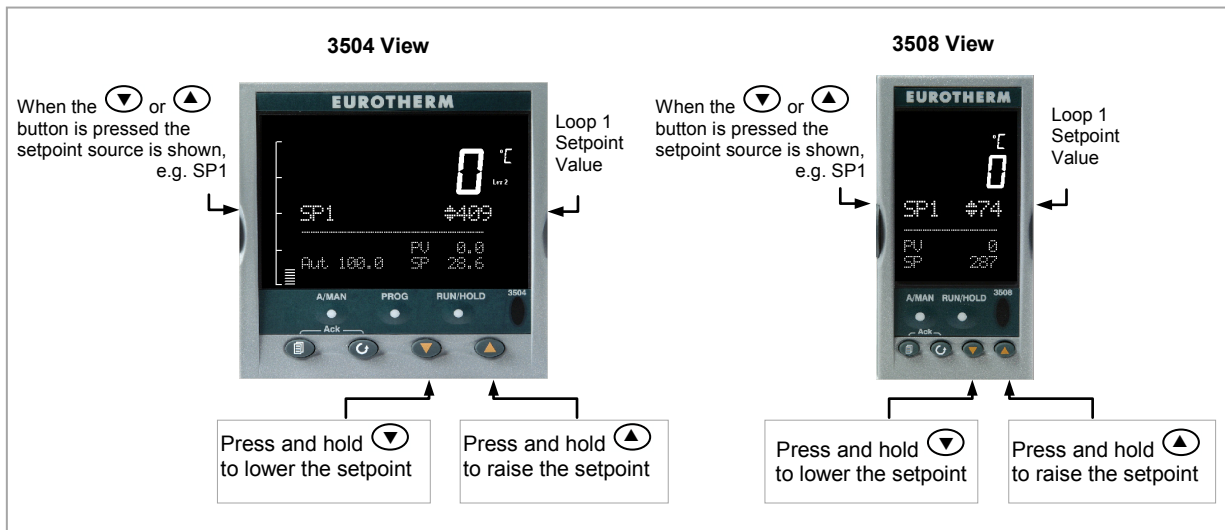

Figure 2-3: Temperature Setting

To change Loop 2 setpoint, press  $\odot$ .

Loop 2 SP value is preceded by  $\blacktriangleleft$ .

Press  $\blacktriangledown$  or  $\blacktriangle$  as above to change the value.

The action is then the same as for loop 1.

A momentary press of either button will show the setpoint in use eg SP1.

**By default the new setpoint is accepted when the button is released and is indicated by a brief flash of the setpoint display**

The setpoint may be made to operate continuously by enabling the parameter 'ImmSP?' (see section 6.4)

If a single loop is configured (or the individual loop summary is selected – see section 2.8.1) pressing  $\blacktriangledown$  or  $\blacktriangle$  will change the setpoint in the same way as described above.



## 2.6 To Select Auto/Manual Operation

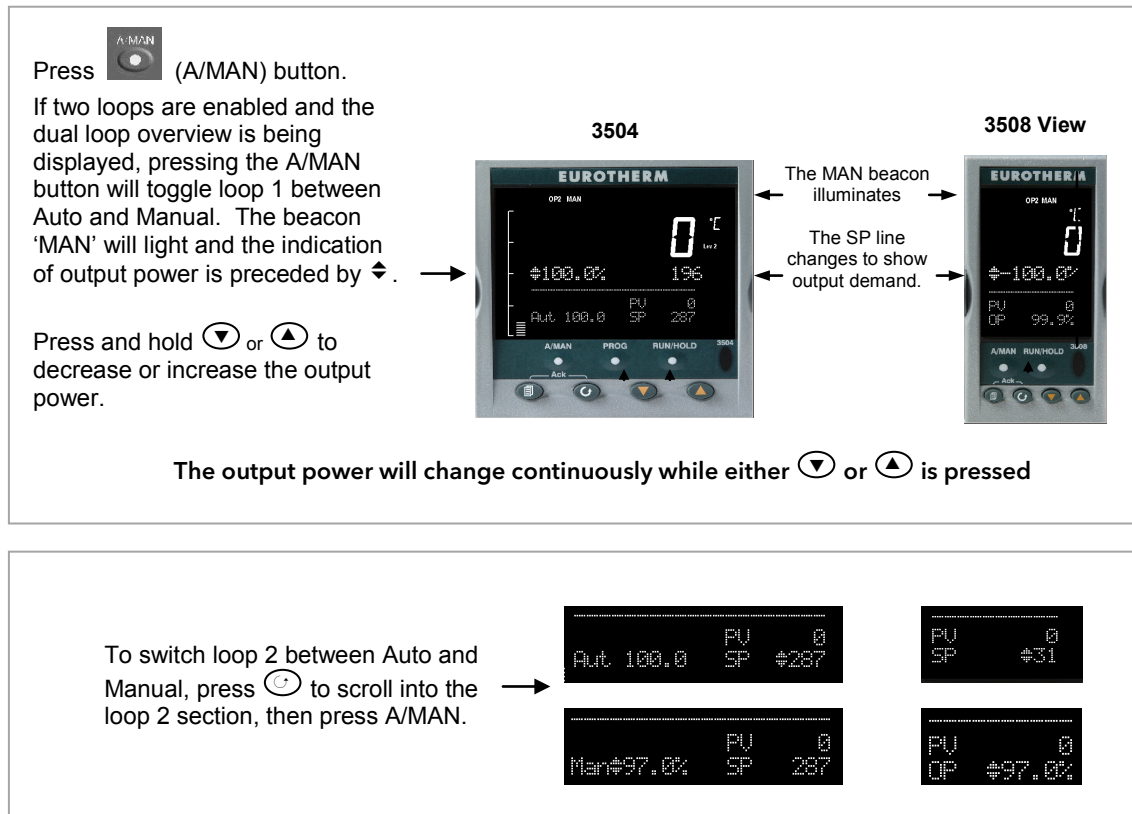



Figure 2-4: Auto/Manual Selection

If loop 1 overview is being displayed, press the A/MAN button to toggle loop 1 between Auto and Manual.

If loop 2 overview is being displayed, press the A/MAN button to toggle loop 2 between Auto and Manual.

If any other overview is being displayed, the first press of the A/MAN button will select the dual loop overview and the action is as described above.

 Summary pages may be disabled - see section 6.5.

- For a dual loop controller, Auto/Manual cannot be selected.
- If loop 1 is enabled and loop 2 disabled, pressing A/MAN toggles Auto/Manual for loop 1.
- If loop 2 is enabled and loop 1 disabled, pressing A/MAN toggles Auto/Manual for loop 2.

 For a single loop controller, Auto/Manual will apply regardless of whether summary pages are enabled or not.

 If the controller is switched off in either Auto or Manual operation it will resume the same mode when powered up again.

### 2.6.1 Bumpless Transfer

When changing from Auto to Manual, the power output will remain at the level it was prior to the change. The power output can then be ramped up or down as described above

When changing from Manual to Auto there will be no immediate change in the power output due to the 'Integral De-Bump' feature (see section 21.5.9). The power output will then slowly ramp to the level demanded by the controller.

## 2.7 Alarm Indication

If an alarm occurs it is indicated as follows:-

The red alarm (ALM) beacon in the top left of the display flashes

Alarm number is indicated together with the flashing 

A default or pre-programmed message appears showing the source of the alarm

Invitation to acknowledge the new alarm

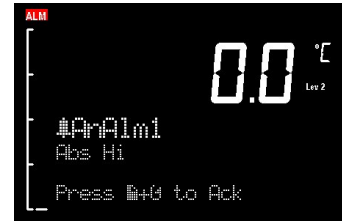

### 2.7.1 To Acknowledge an Alarm Press and (Ack) together.

The action, which now takes place, will depend on the type of latching, which has been configured

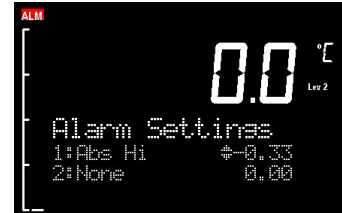

### Non Latched Alarms

If the alarm condition is present when the alarm is acknowledged, the alarm beacon will be continuously lit. This state will continue for as long as the alarm condition remains. When the alarm condition disappears the indication will also disappear.

If a relay has been attached to the alarm output, it will de-energise when the alarm condition occurs and remain in this condition until the alarm is acknowledged **AND** it is no longer present.

If the alarm condition disappears before it is acknowledged the alarm indication disappears as soon as the condition disappears.

### Automatic Latched Alarms

The alarm continues to be active until both the alarm condition is removed **AND** the alarm is acknowledged. The acknowledgement can occur **BEFORE** the condition causing the alarm is removed.

### Manual Latched Alarms

The alarm continues to be active until both the alarm condition is removed **AND** the alarm is acknowledged. The acknowledgement can only occur **AFTER** the condition causing the alarm is removed.

### 2.7.2 Sensor Break Indication

An alarm condition (*S.br*) is indicated if the sensor or the wiring between sensor and controller becomes open circuit or the input is over-range. The message 'Sbreak' is shown in the message centre together with the source of the sensor connection. This may be 'PVIinput' or 'Modx' if an analogue module is fitted.

For a resistance thermometer input, sensor break is indicated if any one of the three wires is broken.

For mA input sensor break will not be detected due to the load resistor connected across the input terminals.

For Volts input sensor break may not be detected due to the potential divider network connected across the input terminals.

## 2.8 Message Centre

The lower section of the HOME display contains an alpha-numeric set of messages. These messages change between different controller types and operating modes and are grouped in summary pages. The 3504 contains more information than the 3508, and generally the parameter descriptions are longer due to the larger display.

### 2.8.1 Summary Pages

Press . A set of pre-defined summary pages are shown at each press - the following views show examples. These are typically a summary of programmer, loops and alarm operation. A further eight customised pages can be programmed off line using iTools programming software. The level in which the Summary Pages are shown may also be defined using iTools.

If Auto-tune is enabled an alternating message is shown on this display showing the loop being tuned and the stage of tuning, eg Loop1 Auto-Tune/ToSP.

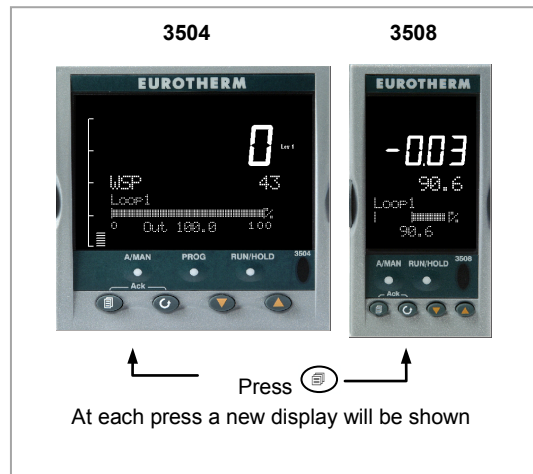

#### 2.8.1.1 Loop Summary

If two loops are configured the display shown in section 2.3 is shown.

Press  to display a summary for Loop1 and again for Loop 2.

The horizontal bar graph shows output power demand for the loop. For **heat/cool** the bar graph is bi-directional ( $\pm 100\%$ ) as shown:-

For **valve position** control the user interface will display either heat only or heat/cool summary pages. A timeout to the dual loop overview may be changed in configuration level, see parameter 'Home Timeout' in section 6.5.1.



#### 2.8.1.2 Program Status

This display is only shown if the Programmer option has been enabled

SyncAll and single programmers →

```
Program Status
Program      #1
Segment     1:Time
Sea Time Lef 0:08:21
```

```
ProgStat
Status
#Reset
```

SyncStart programmer →

```
Program Status
Pra#1       Ch2
Segment     1:Time
Sea Time Lef 5:33:58
```

```
ProgStat
Pra#1 Ch2
Segment 1
0:43:00
```

#### 2.8.1.3 Program Edit

Allows the program to be created or edited.

SyncAll and single programmers →

```
Program Edit
Program      #1
Segments Used 1
ChHoldBkVal 0
```

```
ProgEdit
Program
#1
```

SyncStart programmer →

```
Program Edit
Pra#1       Ch1
Segments Used 2
Holdback Value 0
```

```
ProgEdit
Pra#1 Ch1
```

A full list of parameters is given in section 2.8.3



 **Note:** For a SyncStart programmer it is possible to select between Channel 1 and Channel 2..

**2.8.1.4 Alarm Summary**

Press  to scroll through the alarms.  
 A New Alarm occurs when any new alarm becomes active. This parameter may be used to activate a relay output to provide external audible or visual indication.



**2.8.1.5 Alarm Settings**

All configured alarms (up to eight) will be listed.  
 Press  to scroll through the alarms.  
 Press  or  to set the threshold values



**2.8.1.6 Control**

To set parameters which define the operation of the loops. A full list of parameters is given in section 2.8.4.



**2.8.1.7 Transducer**



This display is only shown if the Transducer option has been enabled.  
 For further details see Chapter 24.



A further eight customised pages can be configured using iTools configuration package. See chapter 27 for further details.

## 2.8.2 How to Edit Parameters



In the above summary pages, press  to scroll to further parameters (where applicable).

Press  or  to change the value of the parameter selected.

Any parameter preceded by  is alterable provided the system is in a safe state to allow the parameter to be changed. For example, 'Program Number' cannot be changed if the program is running - it must be in 'Reset' or 'Hold' mode. If an attempt is made to alter the parameter its value is momentarily replaced by '---' and no value is entered.

Some parameters are protected under a higher level of security – Level 2. In these cases it will be necessary to select 'Access Level 2'. This is carried out as follows:-



1. Press and hold  until the display shows
2. Press  to select Level 2
3. Press  again to enter a security code. This is defaulted to 2. If an incorrect code is entered the display reverts to that shown in 1 above. If the default of 2 is not accepted this means that the code has been changed on your particular controller.
4. 'Pass' is displayed momentarily. You are now in Level 2.

### 2.8.3 Program Status Page

Provided it has been ordered and enabled the 3500 series controllers can program the rate of change of setpoint. Two program channels are available which can be run as two separate programmers or as a pair. Up to 50 programs and up to a maximum of 500 segments can be stored and run. Setpoint programming is explained in more detail in Chapter 22.

#### 2.8.3.1 To Select a Parameter

Press  to scroll through a list of parameters. On the 'Programmer Summary' shown here, the list of parameters which can be selected are:-



Parameter Name	Parameter Description	Value		Default	Available in Level
Program	Program number (and name if this has been configured)	1 to max number of programs		1	L1 Alterable when prog in reset
Segment	Segment number (and type on 3504) Only appears when the programmer is running	1 to max number of segments		1	L1
Seg Time Left	Segment Time Left Only appears when the programmer is running	hrs:mins:secs		Read only	L1
Delayed Start	Program will run after a set time has elapsed	0:00 to 499:99		0:00	L1 if configured
Status	Program Status	End Run Hold Holdback	Prog ended Prog running Prog held In holdback <a href="#">See note below</a>		L1
Ch1 PSP (or PSP)	Profile setpoint value channel 1	Can be changed in Hold			L1
Ch2 PSP	Profile setpoint value channel 2	Can be changed in Hold			L1
Fast Run	This allows the program to be run at a fast rate and may be used for testing the program. It can only be selected before the program is run.	No/Yes		No	
Rst UsrVal	User value to be used in reset state. Defines the value for 'UsrValOP'. In segments that specify 'PVEvent', 'UsrValOP' is set to this value Only appears when the program is in reset mode.				
Ch1 Seg Target (or Segment Target)	Requested setpoint at end of segment				
Ch2 Seg Target					
Seg. Duration (or Segment Rate)	Segment time – Time to Target programmer Rate of change of SP – Ramp Rate programmer				
Cur. Seg Type	Single programmer only				
Cycles Left	Number of repeat cycles left to run Can only be changed in Hold or Reset	1 to maximum number of cycles set			L1 R/O in Run
Events or Rst Events	State of the event outputs when the program is running or when in reset	<input type="checkbox"/> Event inactive <input checked="" type="checkbox"/> Event active			L1
PrgTimeLeft	Time remaining to end of selected program	hrs:mins:secs			L1
GoBackCyclesLeft	The number of cycles left if Go Back is configured and active	1 to maximum number of cycles set			

**Note:**

Holdback freezes the program if the process value (PV) does not track the setpoint (SP) by more than a user defined amount. The instrument will remain in HOLDBACK until the PV returns to within the requested deviation from setpoint. The display will flash the HOLD beacon.

In a **Ramp** it indicates that the PV is lagging the SP by more than the set amount and that the program is waiting for the process to catch up.

In a **Dwell** it freezes the dwell time if the difference between the SP and PV exceeds the set limits.

In both cases it maintains the correct soak period for the product, see also section 22.5.

In addition to the usual PV Holdback, Holdback is also the state when synchronisation is taking place.











For a SyncAll programmer, this occurs if Holdback has caused one PSP to be held back while the other has progressed to completion.



For a SyncStart programmer, this occurs when Ch1/2 is waiting for the other channel.

In both models, it occurs when a Wait segment has been configured and is active. When one channel has reached the end of the first cycle and is waiting for the other channel to complete its first cycle. Both channels will start cycle 2 only when they have both completed. (Implied Sync point at the end of each cycle).



**2.8.3.2 To Select and Run a Program**



In this example it is assumed that the program to be run has already been entered. Setpoint programming is described in detail in Chapter 22

Do This	The Display You Should See	Additional Notes
1. Press  2. Press  or  to choose the program number to be run		In this example Program Number 1. It may also have a user defined name.  In the 3504 Program names can be entered using the off-line programming package 'iTools'
3. Press  again		If a delayed start has been configured the program will start to run after the delay period set.. The 'RUN' beacon is illuminated at the top of the display.  The view shown here shows program being run, segment number and type and time left to complete this segment.
4. Repeated pressing of  will scroll through parameters associated with the running program. The parameters are listed in the above table		These show current value of channel 1 setpoint and current value of channel 2 setpoint. The target value of channel 1 is also shown.
5. To Hold a program press 		Press  again to continue the program.  When the program is complete 'RUN' will flash
6. To Reset a program press and hold  for at least 3 seconds		'RUN' will extinguish and the controller will return to the HOME display shown in section 2.3.

Alternatively, run, hold or reset a program by scrolling to 'Program Status' using  and select 'Run', 'Hold' or 'Reset' using  or .

The  button (3504 only) provides a short cut to the Program Status page from any view.

When the programmer is running, the controller overview may be displayed by pressing  and  together.



WSP is the Working Setpoint and is the current setpoint derived from the programmer. To change the value of WSP the programmer must be put into Hold, then it can be adjusted using the buttons  or . By default the new value is entered after the button is released and is indicated by a brief flash of the value.

However, it is possible to select an option where the value is entered continuously as the raise or lower button is depressed. This option (ImmSP) is selected in configuration level as described in section 6.4.





### 2.8.3.3 Program Edit Page

A program can be edited in any level. A summary of the Edit Page is given here but for a full description refer to Chapter 22. A program may be only edited when it is in Reset or Hold. Press  until the Program Edit page is shown. Then press  to scroll through a list of parameters shown in the following table – parameters only appear in this table if the relevant option has been configured:-

Para Name	Parameter Description	Value	
Program	Program number (and name if this has been configured)	1 to max number of programs	
Segments Used	Displays the number of segments in the program. This value automatically increments each time a new segment is added	1 to max number of segments	
Cycles	Number of times the whole program repeats	Cont 1 to 999	Continuous Repeats 1 to 999 times
Segment	To select the segment number	1 to 50	
Segment Type	Defines the type of segment. The type of segment varies depending on whether the program is Single, SyncAll or SyncStart. Call only available in single programmer Rate, Dwell, Step not available in SyncAll programmer	Rate	Rate of change of SP
		Time	Time to target
		Dwell	Soak at constant SP
		Step	Step change to new SP
		Wait	Wait for condition
		GoBack	Repeat previous segs
		Call	Insert new program
		End	Final segment
Target SP	Value of SP required at the end of the segment	Range of controller	
Ramp Rate	Rate of change of SP	Units/sec, min or hour	
Holdback Type	Deviation between SP and PV at which the program is put into a hold condition to wait for the PV to catch up. Only appears if configured	Off	No holdback
		Low	PV<SP
		High	PV>SP
		Band	PV<>SP
PV Event	To set the analogue PV event in the selected segment. If PV Event ≠ None it is followed by 'PV Threshold' which sets the level at which the event becomes active. Only appears if configured	None	No PV Event
		Abs Hi	Absolute high
		Abs Lo	Absolute low
		Dev Hi	Deviation high
		Dev Lo	Deviation low
		Dev Band	Deviation band
Time Event	To allow an On Time and an Off Time to be set in the first program event output. If set to 'Event1' an On time parameter and an Off Time parameter follow. Only appears if configured	Off Event1	
UsrVal	Sets the value of an analogue signal which can be used in the segment. Only appears if configured. Using iTools configuration package, it is possible to give this parameter an 8 character name.	Range	
PID Set	To select the PID set most relevant to the segment. Only appears if configured	Set1, Set2, Set3	
Event Outs	Defines the state of up to eight digital outputs. 1 to 8 can be configured	□□□□□□□□ to ■■■■■■■■ or T□□□□□□□ to ■■■■■■■■ T = Time event: □ = event off; ■ = event on	
Duration	Time for a Dwell or Time segment	0:00:00 to 500.00 secs, mins or hours	
GSoak Type	Applies a guaranteed soak in a Dwell segment. See also sections 22.5.1, 22.17.2 and 22.17.4 If configured this parar is followed by a G.Soak Value	Off	
		Low	
		High	
		Band	
End Type	Defines the action to be taken at the end of the program	Dwell	Continue at current SP
		SafeOP	Go to a defined level
		Reset	Reset to start of prog

Para Name	Parameter Description	Value	
Wait For	Only appears if the segment is set as Wait. Defines the condition that the program should wait for.	PrgIn1	The first four parameters are digital values which can be wired to suitable sources
		PrgIn2	
		PrgIn1n2	
		PrgIn1or2	
		PVWaitIP	Analogue wait value
		Ch2Sync	A Ch2 segment input
PV Wait	Only appears if 'PVWaitIP' is configured and defines the type of alarm which can be applied. If this parameter is configured it is followed by 'Wait Val' which allows the trip level to be set for the condition to become true	None	No wait
		Abs Hi	Absolute high
		Abs Lo	Absolute low
		Dev Hi	Deviation high
		Dev Lo	Deviation low
		Dev Band	Deviation band
GoBack Seg	Only appears if the segment type is 'GoBack'. It defines the segment to return to to repeat that part of the program	1 to the number of segments defined	
GoBack Cycles	Sets the number of times the chosen section of the program is repeated	1 to 999	
Call Program	Only applies to single program and only if the segment is 'Call'. Enter the program number to be inserted in the segment	Up to 50 (current program number excluded)	
Call Cycles	Defines the number of times the called program repeats	Cont 1 to 999	Continuous Once to 999 times

### 2.8.4 Control Summary Page

On the Control Summary page the following parameters are available:-

Para Name	Parameter Description	Value	Default	Availability
SP Select	To select SP1 or SP2	Between range limits set in higher levels of access	As order code	Lev1
SP1	To set the value of SP1			Lev1
SP2	To set the value of SP2			Lev1
SP Rate	To set the rate at which the setpoints change			Lev 1 alterable in Lev2
Tune*	To start self tuning	Off, On	Off	* Parameter does not appear if control is configured for On/Off
PB*	To set proportional band	0 to 99999		
Ti*	To set integral time	Off to 99999		
Td*	To set derivative time	Off to 99999		
R2G*	To set relative cool gain	0.1 to 10.0		
CBH*	To set cut back high	Auto to 99999		
CBL*	To set cut back low	Auto to 99999		
Output Hi	To set a high limit on the control output	-100.0 to 100.0%	100.0	
Output Lo	To set a low limit on the control output	-100.0 to 100.0%	0.0	
Ch1 OnOff Hyst	Channel 1 hysteresis (Only if configured and for On/Off control)	0.0 to 200.0		
Ch2 OnOff Hyst	Channel 2 hysteresis (Only if configured and for On/Off control)	0.0 to 200.0		
Ch2 DeadB	Channel 2 deadband. To set the period in which there is no output from either channel. (This does not appear if channel 2 is not configured)	Off to 100.0		
Ch1 TravelT	Motor travel time if valve control output on channel 1	0.0 to 1000.0 sec		
Ch1 TravelT	Motor travel time if valve control output on channel 1	0.0 to 1000.0 sec		
Safe OP	To set an output level under sensor break conditions	-100.0 to 100.0%	0.0	

### 3. Chapter 3 Access to Further Parameters

Parameters are available under different levels of security defined as Level 1, Level 2, Level 3 and Configuration Level. Level 1 has no security password since it contains a minimal set of parameters generally sufficient to run the process on a daily basis. Level 2 allows parameters, such as those used in commissioning a controller, to be adjusted. Level 3 and Configuration level parameters are also available as follows:-

#### 3.1 Level 3

Level 3 makes all operating parameters available and alterable (if not read only)

Examples are:-

Range limits, setting alarm levels, communications address.

The instrument will continue to control when in Levels 1, 2 or 3.

#### 3.2 Configuration Level

This level makes available all parameters including the operating parameters so that there is no need to switch between configuration and operation levels during commissioning. It is designed for those who may wish to change the fundamental characteristics of the instrument to match the process.

Examples are:-

Input (thermocouple type); Alarm type; communications type.





















**Warning:** Configuration level gives access to a wide range of parameters which match the controller to the process. Incorrect configuration could result in damage to the process being controlled and/or personal injury. It is the responsibility of the person commissioning the process to ensure that the configuration is correct.





In configuration level the controller will not necessarily be controlling the process or providing alarm indication. Do not select configuration level on a live process.

Operating Level	Home List	Full Operator	Configuration	Control
Level 1	✓			Yes
Level 2	✓			Yes
Level 3	✓	✓		Yes
Configuration	✓	✓	✓	No

### 3.3 To Select Different Levels of Access

Do This	The Display You Should See	Additional Notes								
<p>1. From any display press and hold </p>		<p>After a few seconds the display will show Goto  Level 1.</p> <p>If no button is pressed for about 2 minutes the display returns to the HOME display.</p> <p>This is a view for the 3504, and shows additional parameters in the list. The 3508 shows these parameters one at a time</p> <p>In either controller, press  to scroll through the list of parameters</p>								
<p>2. Press  or  to choose different levels of access</p>	 <p style="text-align: center;">↓</p> 	<p>The choices are:</p> <p>Level 1</p> <p>Level 2</p> <p>Level 3</p> <p>Configuration</p>								
<p>3. Press  or  to enter the correct code for the level chosen</p>	 <p style="text-align: center;">↓</p> 	<p>The default codes are:</p> <table border="1" data-bbox="943 804 1318 909"> <tr> <td>Level 1</td> <td>None</td> </tr> <tr> <td>Level 2</td> <td>2</td> </tr> <tr> <td>Level 3</td> <td>3</td> </tr> <tr> <td>Configuration</td> <td>4</td> </tr> </table> <p>If an incorrect code is entered the display reverts to the previous view.</p>	Level 1	None	Level 2	2	Level 3	3	Configuration	4
Level 1	None									
Level 2	2									
Level 3	3									
Configuration	4									
<p>4. The controller is now in configuration level in this example</p>		<p>Press  to scroll through the list headers in the chosen level starting with Access List. The full list of headers is shown in the Navigation Diagram, section 4.2.</p>								
<p>5. To return to a lower level, press and hold (if necessary)  to return to the Access Page</p> <p>6. Press  or  to select the level</p>		<p>It is not necessary to enter a code when going from a higher level to a lower level.</p> <p>When Level 1 is selected the display reverts to the HOME display</p> <p>Do not power down while the controller is changing levels. If a power down does occur an error message – <i>ECONF</i> – will appear – see also section 12.6 'Diagnostic Alarms'</p>								

 **Notes:**

1. A special case exists if a security code has been configured as '0'. If this has been done it is not necessary to enter a code and the controller will enter the chosen level immediately.
2. When the controller is in configuration level the ACCESS list header can be selected from any view by pressing  and  together.
3. An alternative way to access configuration level is to power up the instrument with  and  buttons pressed. You will then be asked to enter the security code to take you to configuration level.

### 3.4 Access Parameter List

The following table summarises the parameters available under the Access list header

List Header – Access		Sub-headers: None			
Name ⌚ to select	Parameter Description	Value Press ⏴ or ⏵ to change values		Default	Access Level
Goto	To select different levels of access. Passcodes prevent accidental edit	Lev.1 Lev.2 Lev.3 Config	Operator mode level 1 Operator mode level 2 Operator mode level 3 Configuration level	Lev.1	L1
Level2 Code *	To customise the passcode to access level 2	0 to 9999		2	Conf
Level3 Code *	To customise the passcode to access level 3	0 to 9999		3	Conf
Config Code *	To customise the passcode to access configuration level	0 to 9999		4	Conf
IR Mode	To activate/de-activate the front panel InfraRed port. This is normally deactivated. The IR port is used to link the instrument to a PC and may be used for configuring the instrument using iTools when a digital comms link is not available. It requires an IR clip, available from Eurotherm, to link your Instrument to a PC.	Off On	Inactive Active	Off	Conf
Customer ID	To set an identification number for the controller	0 to 9999		0	Conf
A/Man Func	This enables or disables the front panel A/MAN button	On Off	Enabled Disabled	On	Conf
Run/Hold Func	This enables or disables the front panel RUN/HOLD button	On Off	Enabled Disabled	On	Conf
Keylock	When set to 'All' no front panel key is active. This protects the instrument from accidental edits during normal operation. To restore access to the keyboard from operator levels, power up the instrument with the ⏴ and ⏵ buttons pressed. This will take you directly to the configuration level password entry.	None All	Front panel keys active All Edits and Navigation are prevented.	None	Conf
Standby	Set to 'Yes' to select standby mode. In standby all control outputs are set to zero. The controller automatically enters standby mode when it is in Configuration level or during the first few seconds after switch on.	No Yes		No	Conf



**Caution:** \* When changing passwords please make a record the new password

List Header – Access		Sub-headers: None			
Name ⌂ to select	Parameter Description	Value ▼ or ▲ to change		Default	Access Level
Clear Memory	This parameter only appears if Config Code = 0. See Warning below.	No	Disabled	No	Conf
		App	Controller memory reset but comms and lin tables retained		
		LinTables	Custom linearisation tables are deleted		
		InitComms	Communications ports reset to default configuration		
		Wires	Clears all wiring		
		AllMemory	Initialises all memory except linearisation tables after firmware upgrade		
		Programs	Clears all programs		
Raise Key	These parameters allow keys to be wired, for example, to digital inputs so that the function can be controlled externally	Off	Shows the current state of the function		Conf
Lower Key		On			
Page Key					
Scroll Key					
Auto/Man Key					
Run/Hold Key					
Prog Key					



**Warning: Clear Memory must be used with care.**  
**When selected it initialises the controller to default values.**

The format of this table is used throughout this manual to summarise all parameters in a list.

The title of each table is the list header.

Column 1 shows the mnemonic (Name) of the parameter as it appears on the display

Column 2 describes the meaning or purpose of the parameter

Column 3 the value of the parameter

Column 4 a description of the enumeration

Column 5 the default value set when the controller is first delivered

Column 6 the access level for the parameter. If the controller is in a lower access level the parameter will not be shown

## 4. Chapter 4 Function Blocks

The controller software is constructed from a number of 'function blocks'. A function block is a software device which performs a particular duty within the controller. It may be represented as a 'box' which takes data in at one side (as inputs), manipulates the data internally (using parameter settings) and 'outputs' the data. Some of these parameters are available to the user so that they can be adjusted to suit the characteristics of the process which is to be controlled.

A representation of a function block is shown below.

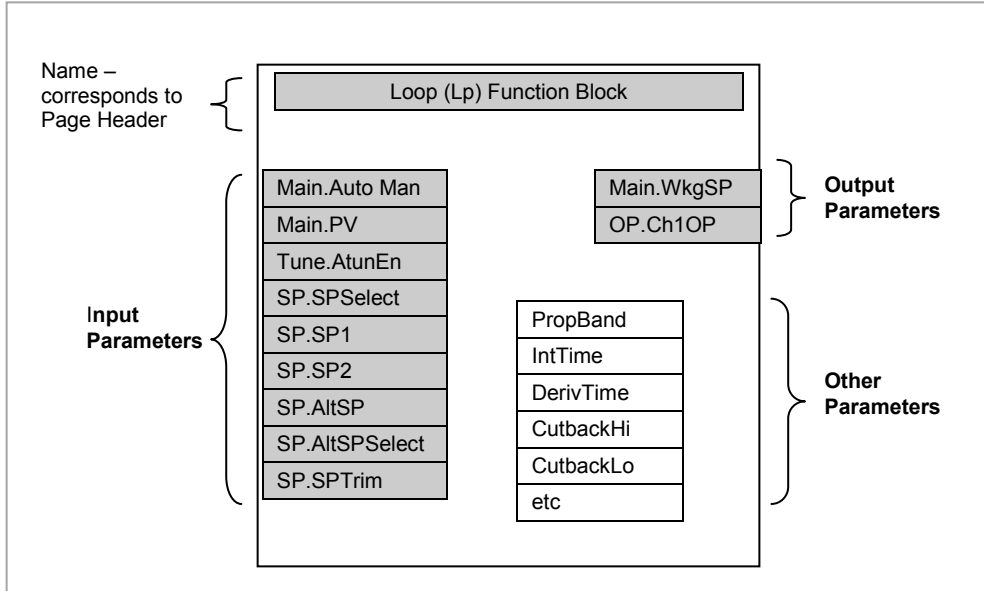



Figure 4-1: Example of a Function Block

In the controller, parameters are organised in simple lists. The top of the list shows the list header. This corresponds to the name of the function block and is generally presented in alphabetical order. This name describes the generic function of the parameters within the list. For example, the list header 'AnAlm' contains parameters which enable you to set up analogue alarm conditions.

In this manual the parameters are listed in tables similar to that shown in section 3.4. The tables include all possible parameters available in the selected block but in the controller only those available for a particular configuration are shown.



### 4.1 To Access a Function Block

Press the Page button  until the name of the function block is shown in the page header.

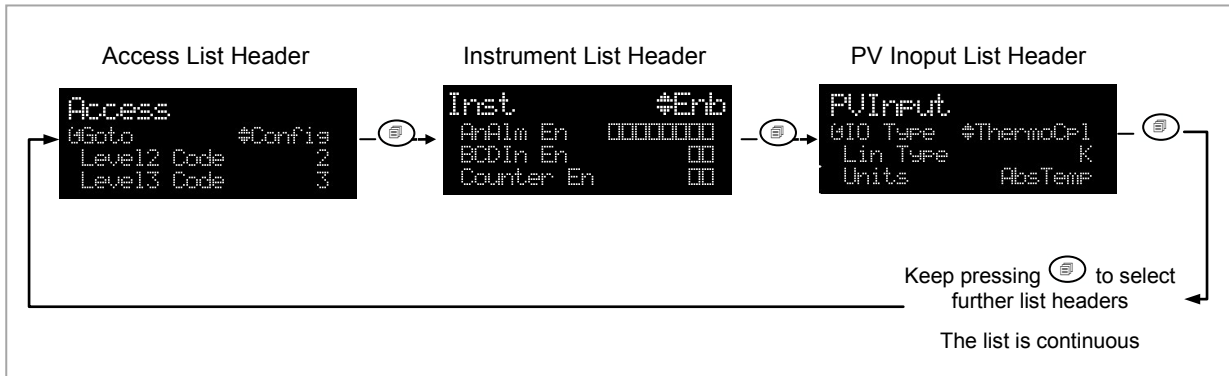

Figure 4-2: Parameter List Headings

#### 4.1.1 Sub-Lists or Instances

In some cases the list is broken down into a number of sub-headers to provide a more comprehensive list of parameters. An example of this is shown above for the Instrument List. The sub-header is shown in the top right hand corner (as  $\blacklozenge$  Enb in the diagram). To select a different sub-header press  $\blacktriangle$  or  $\blacktriangledown$ .

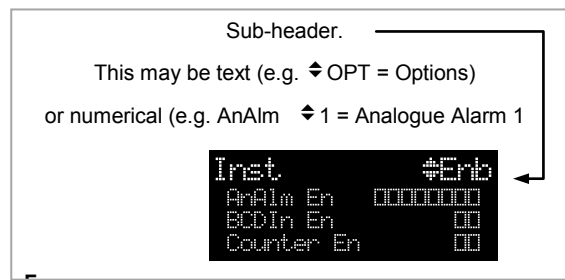



Figure 4-3: Sub-Header

#### 4.1.2 To Access a Parameters in a Function Block

Press the scroll button  until the required parameter is located.

Each parameter in the list is selected in turn each time this button is pressed. The following example shows how to select the first two parameters in the Alarm List. All parameters in all lists follow the same format.

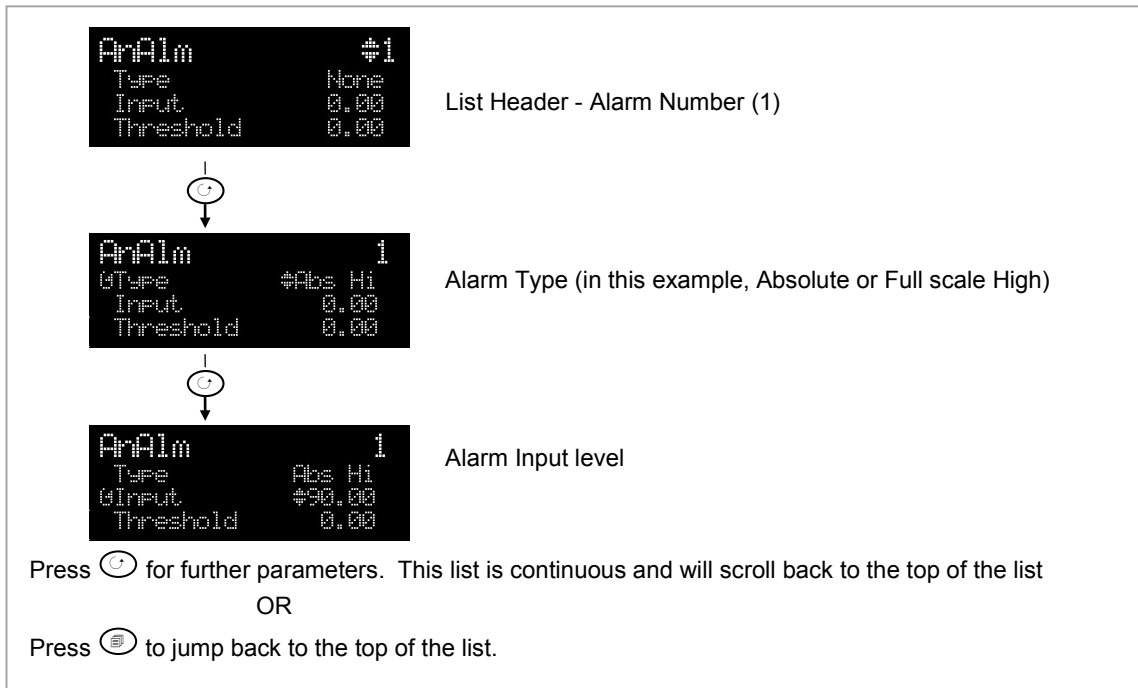





Figure 4-4: Parameters

### 4.1.3 To Change the Value of a Parameter

Press  or  to raise or lower the value of an analogue (numeric) parameter or to change the selection of enumerated parameter options.

Any parameter preceded by  is alterable provided the system is in a safe state to allow the parameter to be changed. For example, 'Program Number' cannot be changed if the program is running - it must be in 'Reset' mode. If an attempt is made to alter the parameter its value is momentarily replaced by '---' and no value is entered.

#### 4.1.3.1 Analogue Parameters

When the raise or lower button is first depressed there is a single increment or decrement of the least significant digit. Either button can be held down to give a repeating action at an accelerating rate.

#### 4.1.3.2 Enumerated Parameters

Each press of the raise or lower button changes the state of the parameter. Either button can be held down to give a repeating action but not at an accelerating rate. Enumerated parameters are allowed to wrap around.

#### 4.1.3.3 Time Parameters

Time parameters start with a resolution of 0.1 second    mm:ss.s    0:00.0 to 59:59.9

When 59:59.9 is reached the resolution becomes 1 second    hh:mm:ss    1:00:00 to 99:59:59

When this limit is reached the resolution becomes 1 minute    hhh:mm    100:00 to 500:00

#### 4.1.3.4 Boolean Parameters

These are similar to enumerated parameters but there are only two states. Pressing either the raise or lower button causes the parameter to toggle between states.

#### 4.1.3.5 Digital Representation Characters

Parameters whose values are used digitally (i.e. bitfields) are represented by:

- On State or
- Off State

A parameter may be represented by using any number of bits between 1 and 16 inclusive. Scrolling on to the parameter selects the leftmost bit, and subsequent scroll operations move the selected bit right by one. Backscroll may be used to move the selected bit towards the left. Raise and lower buttons are used to turn the selected bit on or off respectively.

### 4.2 Navigation Diagram

The diagram below shows all the function blocks available in the 3500 series controllers as list headings in configuration level. A function block will not be shown if it has not been enabled or ordered, if it is a chargeable option.

Select in turn using  :-

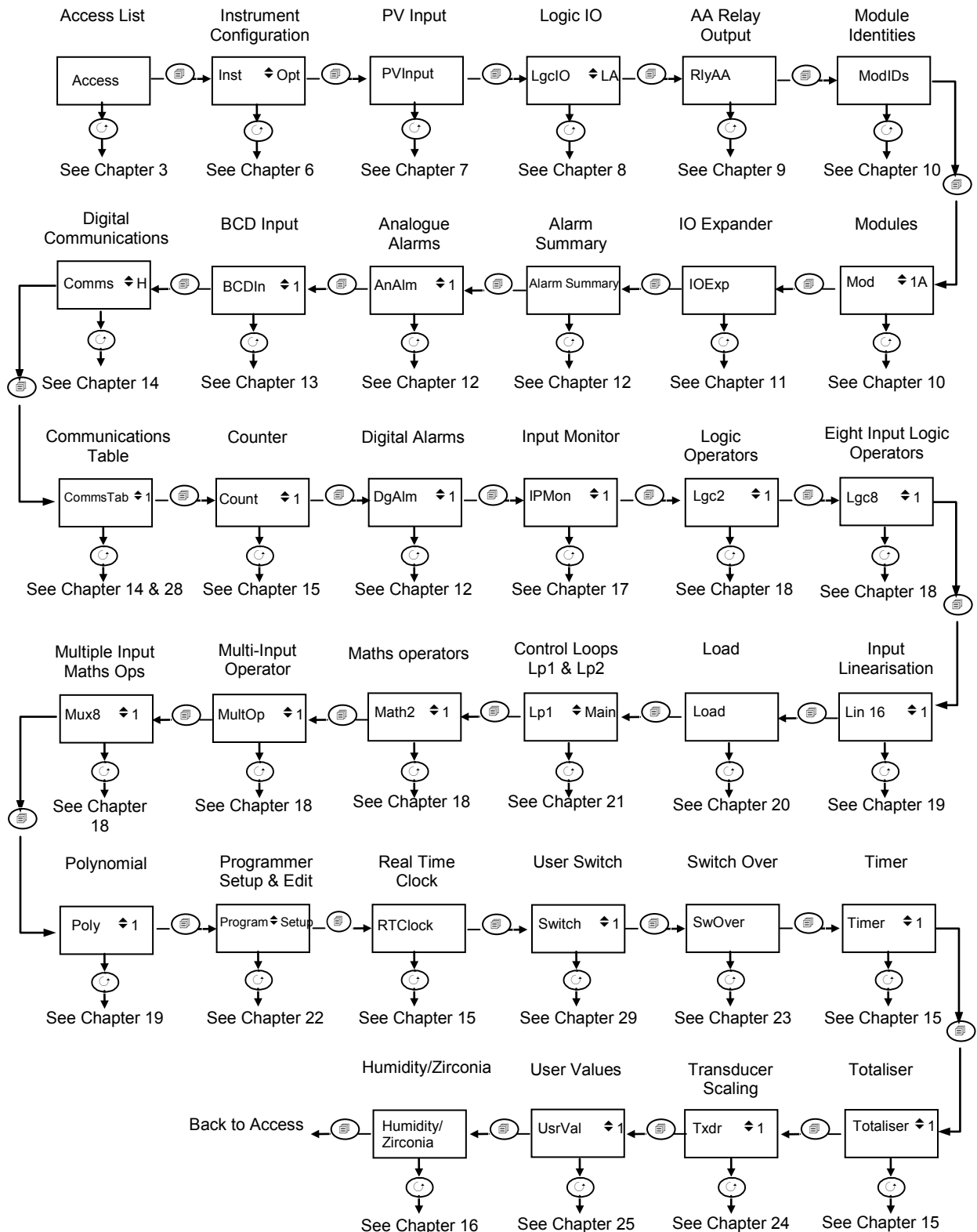

Figure 4-5: Navigation Diagram

## 5. Chapter 5 Function Block Wiring

Input and output parameters of function blocks are wired together in software to form a particular instrument or function within the instrument. A simplified overview of how these may be interconnected to produce a single control loop is shown below.

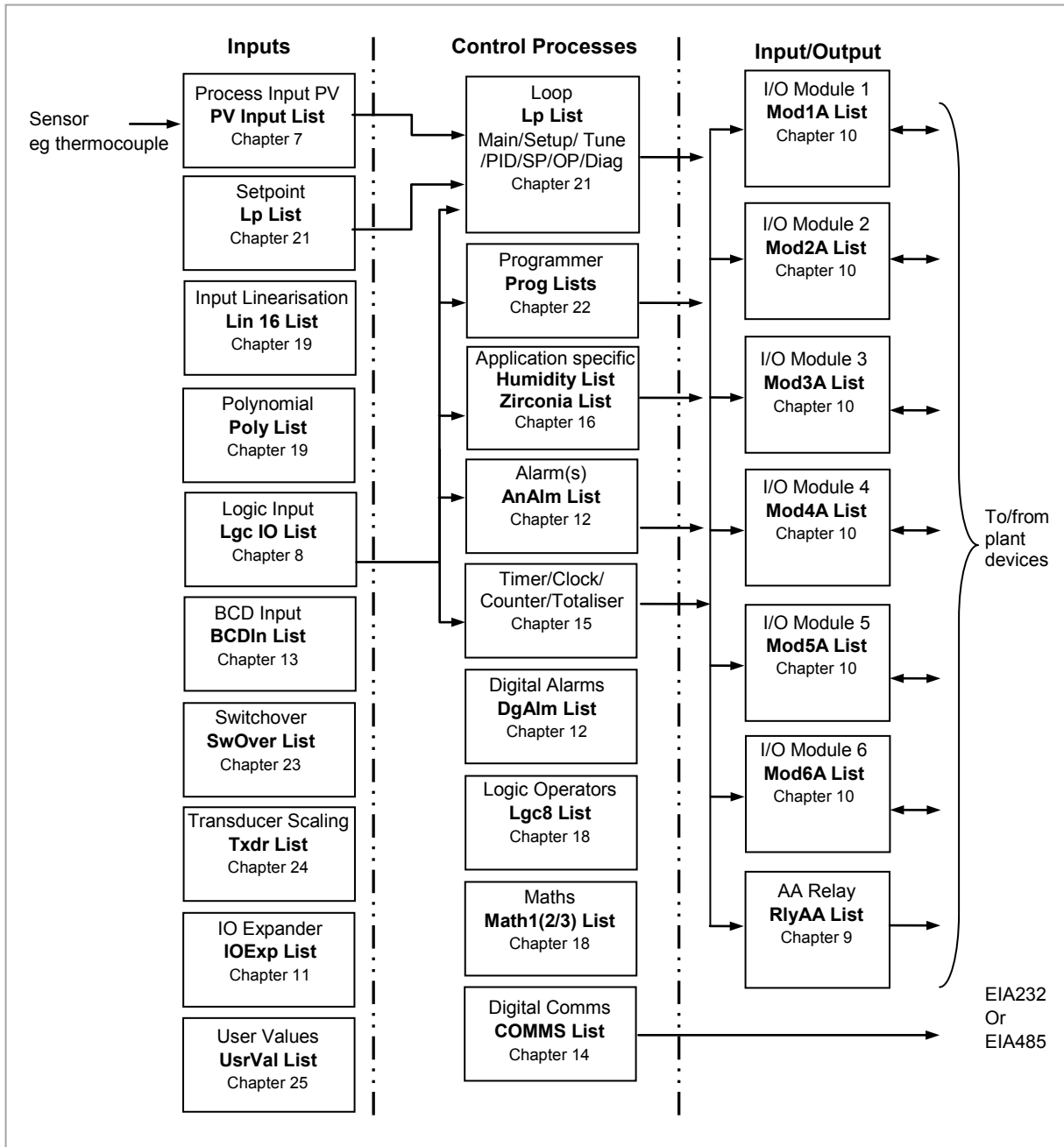

Figure 5-1: Controller Example

Function blocks are wired (in software) using the Quick Start mode and/or full configuration mode. In the controller example here, the Process Variable (PV) is measured by the sensor and compared with a Setpoint (SP) set by the user.

The purpose of the control block is to reduce the difference between SP and PV (the error signal) to zero by providing a compensating output to the plant via the output driver blocks.

The timer, programmer and alarms blocks may be made to operate on a number of parameters within the controller, and digital communications provides an interface to data collection and control.

The controller can be customised to suit a particular process by 'soft wiring' between function blocks. The procedure is described in the following sections.

## 5.1 Soft Wiring

Soft Wiring (sometimes known as User Wiring) refers to the connections which are made in software between function blocks. Soft wiring, which will generally be referred to as 'Wiring' from now on, is possible through the operator interface of the instrument. This is described in the next section but it is recommended that this method is only used if small changes are required, for example, when the instrument is being commissioned.

**The preferred method of wiring uses the iTools configuration package since it is quicker and easier. Wiring using iTools is described in chapter 27.**

### 5.1.1 Wiring Example

In general every function block has at least one input and one output. Input parameters are used to specify where a function block reads its incoming data (the 'Input Source'). The input source is usually wired to the output from a preceding function block. Output parameters are usually wired to the input source of subsequent function blocks.

The value of a parameter which is not wired can be adjusted through the front panel of the controller provided it is not Read Only (R/O) and the correct access level is selected.

All parameters shown in the function block diagrams are also shown in the parameter tables, in the relevant chapters, in the order in which they appear on the instrument display (alphabetical).

Figure 5-2 shows an example of how the channel 1 (heat) output from the PID block might be wired to the logic output connected to terminals LA/LC.

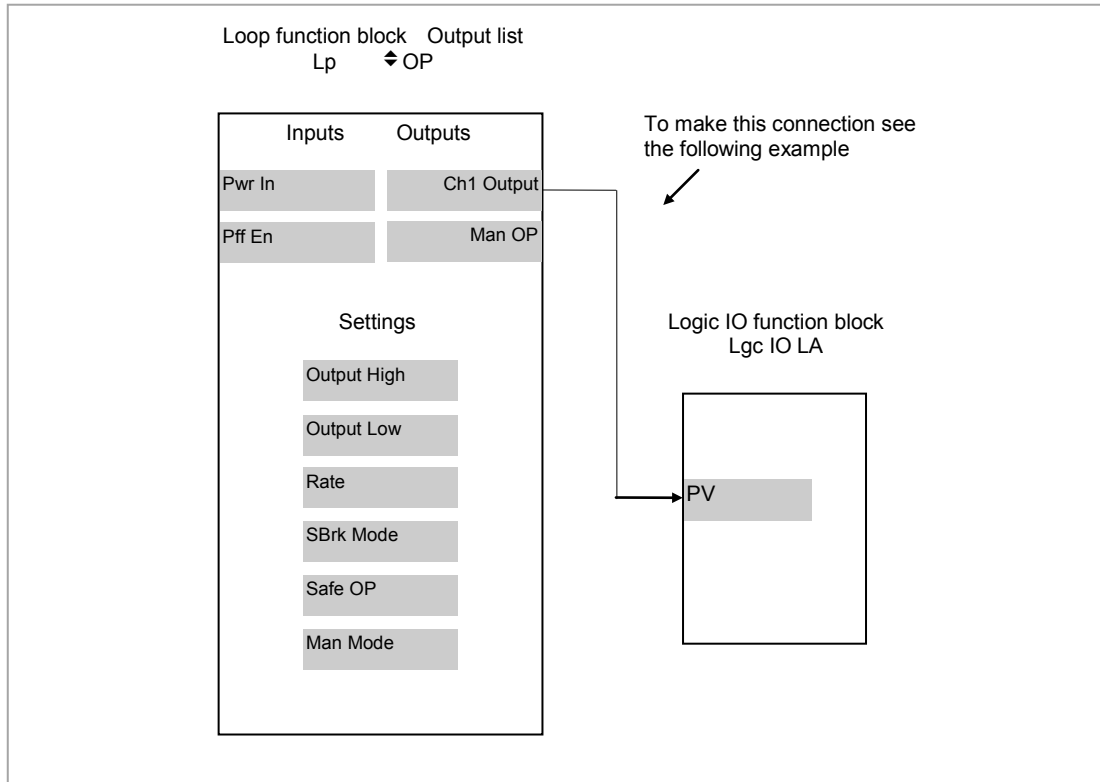















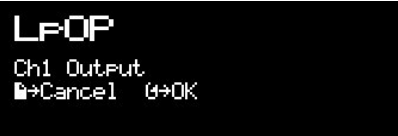



Figure 5-2: Function Block Wiring

### 5.1.2 Wiring Through the Operator Interface









The example shown in the previous section will be used.

Select configuration level as described in section 3.3.

Then:-

Do This	The Display You Should See	Additional Notes
<ol style="list-style-type: none"> <li>From any display press  to locate the page in which the parameter is to be found. (In this example 'LgcIO' page)</li> <li>Press  or  if necessary to select a sub-header. (In this example 'LA')</li> <li>Press  to scroll to the parameter to be wired TO. (In this example 'PV')</li> </ol>	 <p>↑ Indicates parameter selected</p>	<p>This locates the parameter you want to wire TO</p>
<ol style="list-style-type: none"> <li>Press  to display 'WireFrom'</li> </ol>		<p>In configuration mode the A/MAN button is the Wire button.</p>
<ol style="list-style-type: none"> <li>Press  (as instructed) to navigate to the list header which contains parameter you want to wire FROM.</li> </ol>		<p>You will also need to use  or  to select a sub-header, if appropriate, and  to scroll to the parameter - in this example 'Ch1 Output' in the 'Lp OP' page</p>
<ol style="list-style-type: none"> <li>Press </li> </ol>		<p>This 'copies' the parameter to be wired FROM</p>
<ol style="list-style-type: none"> <li>Press  as instructed to confirm</li> </ol>	 <p>↑ Indicates that the parameter is wired.</p> <p>If you want to inspect this press .</p> <p>Press  again to go back to the display above.</p>	<p>This 'pastes' the parameter to 'PV'</p>

### 5.1.3 To Remove a Wire

Do This	The Display You Should See	Additional Notes
1. Select the wired parameter eg LgcIO PV in the above example,		
2. Press 		This locates the parameter you want to wire TO
3. Press Ack to clear the 'WireFrom' display		This is the quick way to select no wire. You can also select this by pressing  repeatedly
4. Press 		
5. Press  to OK		

### 5.1.4 Wiring a Parameter to Multiple Inputs

You can repeat the procedure given in section 5.1.2. but it is also possible to 'Copy' and 'Paste' a parameter. In configuration level the RUN/HOLD button becomes a copy function. The following example wires Ch1 Output to both LA and LB PV inputs.

Do This	The Display You Should See	Additional Notes
1. Select Ch1 Output		
2. Press RUN/HOLD		This copies channel 1 output
3. Select the parameter to wire to. In this case LgcIO LA PV		
4. Press		
5. Press RUN/HOLD		
6. Press		
7. Press  to OK		
8. Now repeat 3 to 8 but for LgcIO LB		

### 5.1.5 Wiring Using iTools

The recommended method of wiring is to use iTools.

A description of how iTools may be used for graphical wiring is given in Chapter 27.



### 5.1.6 Wiring Floats with Status Information

There is a subset of float values which may be derived from an input which may become faulty for some reason, e.g. sensor break, over range, etc. These values have been provided with an associated status which is automatically inherited through the wiring. The list of parameters which have associated status is as follows:-

Block	Input Parameters	Output Parameters
Loop.Main	PV	PV
Loop.SP		TrackPV
Loop.OP	CH1PotPosition	
	CH2PotPosition	
Math2	In1	
	In2	
		Out
Programmer.Setup	PVIn	
Poly	In	
		Out
Load		PVOut1
		PVOut2
Lin16	In	
		Out
Txdr	InVal	
		OutVal
IPMonitor	In	
SwitchOver	In1	
	In2	
		Out

Block	Input Parameters	Output Parameters
Total	In	
Mux8	In1..8	
		Out
Lgc2	In1	
	In2	
UsrVal	Val	Val
Humidity		RelHumid
		DewPoint
	WetTemp	
	DryTemp	
	PsychroConst	
Pressure		
IO.MOD	A.PV, B.PV, C.PV	A.PV, B.PV, C.PV
IO.PV	PV	PV
MultiOper	Cascln	SumOut
	In1 to 8	MaxOut
		MinOut
		AvOut

Parameters appear in both lists where they can be used as inputs or outputs depending on configuration. The action of the block on detection of a 'Bad' input is dependent upon the block. For example, the loop treats a 'Bad' input as a sensor break and takes appropriate action; the Mux8 simply passes on the status from the selected input to the output, etc.

The Poly, Lin16, SwitchOver, Mux8, Multi-Operator, IO.Mod, and IO.PV blocks can be configured to act on bad status in varying ways. The options available are as follows:-

**0: Clip Bad**

The measurement is clipped to the limit it has exceeded and its status is set to 'BAD', such that any function block using this measurement can operate its own fallback strategy. For example, control loop may hold its output to the current value.

**1: Clip Good**

The measurement is clipped to the limit it has exceeded and its status is set to 'GOOD', such that any function block using this measurement may continue to calculate and not employ its own fallback strategy.

**2: Fallback Bad**

The measurement will adopt the configured fallback value which has been set by the user. In addition the status of the measured value will be set to 'BAD', such that any function block using this measurement can operate its own fallback strategy. For example, control loop may hold its output to the current value.

**3: Fallback Good**

The measurement will adopt the configured fallback value which has been set by the user. In addition the status of the measured value will be set to 'GOOD', such that any function block using this measurement may continue to calculate and not employ its own fallback strategy.

**4: Up Scale**

The measurement will be forced to adopt its high limit. This is like having a resistive pull up on an input circuit. In addition the status of the measured value will be set to 'BAD', such that any function block using this measurement can operate its own fallback strategy. For example, the control loop may hold its output to the current value.

**5: Down Scale**

The measurement will be forced to adopt its low limit. This is like having a resistive pull down on an input circuit. In addition the status of the measured value will be set to 'BAD', such that any function block using this measurement can operate its own fallback strategy. For example, the control loop may hold its output to the current value.

### 5.1.7 Edge Wires

If the Loop.Main.AutoMan parameter was wired from a logic input in the conventional manner it would be impossible to put the instrument into manual from the front panel of the instrument. Other parameters need to be controlled by wiring but also need to be able to change under other circumstances, e.g. Alarm Acknowledgements. For this reason some Boolean parameters are wired in an alternative way. These are listed as follows:-

#### SET DOMINANT

When the wired in value is 1 the parameter is always updated. This will have the effect of overriding any changes through the front panel or through digital communications. When the wired in value changes to 0 the parameter is initially changed to 0 but is not continuously updated. This permits the value to be changed through the front panel or through digital communications.

Loop.Main.AutoMan  
Programmer.Setup.ProgHold  
Access.StandBy

#### RISING EDGE

When the wired in value changes from 0 to 1, a 1 is written to the parameter. At all other times the parameter is not updated by the wire. This type of wiring is used for parameters which start an action and when once completed the block clears the parameter. When wired to, these parameters can still be operated from the front panel or through digital communications.

Loop.Tune.AutotuneEnable  
Programmer.Setup.ProgRun  
Programmer.Setup.AdvSeg  
Programmer.Setup.SkipSeg  
Alarm.Ack  
AlmSummary.GlobalAck  
DigAlarm.Ack  
Txdr.ClearCal  
Txdr.StartCal  
Txdr.StartHighCal  
Txdr.StartTare  
IPMonitor.Reset  
Instrument.Diagnostics.ClearStats

#### BOTH EDGE

This type of edge is used for parameters which may need to be controlled by wiring or but should also be able to be controlled from the front panel or through digital communications. If the wired in value changes then the new value is written to the parameter by the wire. At all other times the parameter is free to be edited from the front panel or through digital communications.

Loop.SP.RateDisable  
Loop.OP.RateDisable  
Comms.BroadcastEnabled  
Programmer.Setup.RunHold  
Programmer.Setup.RunReset

## 5.1.8 Operation of Booleans and Rounding

### 5.1.8.1 Mixed Type Wiring

Parameters of function blocks are one of the following types shown below. Wires which connect one type to another cause a type conversion to occur. The values wired may also be rejected or clipped depending on type and limits.

#### **BOOLEANS (including Edges)**

Any value greater than or equal to 0.5 wired to a boolean (or edge) is considered true. When wired to other values booleans will be considered as 0 or 1.

#### **INTEGER**

Values outside the limits of the integer will be clipped to the limits.

#### **ENUMERATED INTEGER**

Values which are outside the limits of an enumerated parameter or do not have a defined enumeration will not be written.

#### **BINARY INTEGER (PIANO KEYS)**

A value which exceeds the number of bits used by the parameter will be rejected.

#### **FLOAT**

Values outside the limits of a float parameter will be clipped to the limits. Wiring from a float to any other type will be rounded to the nearest integer. Where the value falls half way between two integers it will be rounded towards the higher absolute value. I.e. -3.5 rounds to -4 and +3.5 rounds to +4.

#### **TIME**

Times can only be wired to or from other times or floats. When wired to or from floats the float value is in seconds.

#### **STRING**

String values can not be wired.



**Note:** In 3500 Firmware V1.12 and before floats were truncated, rather than rounded and booleans rejected any value but 0 or 1.

## 6. Chapter 6 Instrument Configuration

### 6.1 What Is Instrument Configuration?



Instrument configuration allows you to:-

1. Enable controller function blocks
2. Enable options
3. Customise the display
4. Read information about the controller
5. Read internal diagnostics

### 6.2 To Select Instrument Configuration

Select Configuration level as described in Chapter 3.

Press  from the Access list. The first view displayed is the header 'Inst' plus the sub-header '◆ Enb'.

This allows you to enable or disable instrument options. The '◆' symbol indicates further sub-headers are available. To select these press  or .

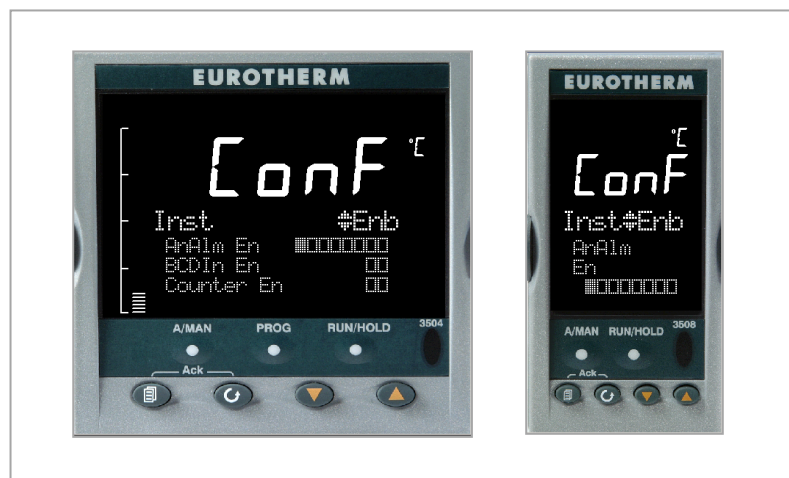





Figure 6-1: Instrument Configuration Displays

### 6.3 Function Block Options



Function blocks are described in Chapter 5. Function blocks may be enabled or disabled in the 'Inst' 'Enb' list. If the function block is enabled a list header containing parameters applicable to the feature will be available as shown in the Navigation diagram, section 4.2. If the option is disabled the list header will not be shown, thus ensuring that only those parameters which are relevant to the application are displayed.



Chargeable options can only be enabled if they have been ordered.

1. Press  to scroll to the option required
2. Press  or  to edit the option.  = Disabled  = Enabled

### 6.3.1 To Enable Function Blocks

The following table lists the options which can be enabled in the controller:-

List Header: Inst		Sub-header: Enb (Enable)		
Name  to select	Parameter Description	Value Press  or  to change values	Default	Access Level
AnAlm	Analogue alarms	<input type="checkbox"/> <input type="checkbox"/> <input type="checkbox"/> <input type="checkbox"/> <input type="checkbox"/> <input type="checkbox"/> <input type="checkbox"/> <input type="checkbox"/> All 8 analogue alarms disabled <input checked="" type="checkbox"/> <input checked="" type="checkbox"/> <input checked="" type="checkbox"/> <input checked="" type="checkbox"/> <input checked="" type="checkbox"/> <input checked="" type="checkbox"/> <input checked="" type="checkbox"/> <input checked="" type="checkbox"/> All 8 analogue alarms enabled		Conf
BCDIn	BCD switch input	<input type="checkbox"/> <input type="checkbox"/> Both inputs disabled <input checked="" type="checkbox"/> <input checked="" type="checkbox"/> Both inputs enabled		Conf
Counter	Counters	<input type="checkbox"/> <input type="checkbox"/> Both counters disabled <input checked="" type="checkbox"/> <input checked="" type="checkbox"/> Both counters enabled		Conf
PackBitEn	Pack bits. Allows up to 16 booleans to be packed into one word	<input type="checkbox"/> <input type="checkbox"/> <input type="checkbox"/> <input type="checkbox"/> All four blocks disabled <input checked="" type="checkbox"/> <input checked="" type="checkbox"/> <input checked="" type="checkbox"/> <input checked="" type="checkbox"/> All four blocks enabled		Conf
UnpackBitEn	Un pack bits. To remove booleans from the word	<input type="checkbox"/> <input type="checkbox"/> <input type="checkbox"/> <input type="checkbox"/> All four blocks disabled <input checked="" type="checkbox"/> <input checked="" type="checkbox"/> <input checked="" type="checkbox"/> <input checked="" type="checkbox"/> All four blocks enabled		Conf
DgAlm	Digital alarms	<input type="checkbox"/> <input type="checkbox"/> <input type="checkbox"/> <input type="checkbox"/> <input type="checkbox"/> <input type="checkbox"/> <input type="checkbox"/> <input type="checkbox"/> All 8 digital alarms disabled <input checked="" type="checkbox"/> <input checked="" type="checkbox"/> <input checked="" type="checkbox"/> <input checked="" type="checkbox"/> <input checked="" type="checkbox"/> <input checked="" type="checkbox"/> <input checked="" type="checkbox"/> <input checked="" type="checkbox"/> All 8 digital alarms enabled		Conf
Humidity	Humidity control	<input type="checkbox"/> Humidity block disabled <input checked="" type="checkbox"/> Humidity block enabled		Conf
IO Exp	IO expander	<input type="checkbox"/> IO expander disabled <input checked="" type="checkbox"/> IO expander enabled		Conf
IP Mon	Input monitor	<input type="checkbox"/> <input type="checkbox"/> Both monitors disabled <input checked="" type="checkbox"/> <input checked="" type="checkbox"/> Both monitors enabled		Conf
Lgc2 En1/En2/En3	Logic operators	<input type="checkbox"/> <input type="checkbox"/> <input type="checkbox"/> <input type="checkbox"/> <input type="checkbox"/> <input type="checkbox"/> <input type="checkbox"/> <input type="checkbox"/> All 8 logic operators disabled <input checked="" type="checkbox"/> <input checked="" type="checkbox"/> <input checked="" type="checkbox"/> <input checked="" type="checkbox"/> <input checked="" type="checkbox"/> <input checked="" type="checkbox"/> <input checked="" type="checkbox"/> <input checked="" type="checkbox"/> All 8 logic operators enabled		Conf
Lgc8	Logic 8 operator	<input type="checkbox"/> <input type="checkbox"/> Both operators disabled <input checked="" type="checkbox"/> <input checked="" type="checkbox"/> Both operators enabled		Conf
Lin16Pt	Input linearisation	<input type="checkbox"/> <input type="checkbox"/> Both input linearisation tables disabled <input checked="" type="checkbox"/> <input checked="" type="checkbox"/> Both input linearisation tables enabled		Conf
Load	Load enable	<input type="checkbox"/> <input type="checkbox"/> Load 1/2 disabled <input checked="" type="checkbox"/> <input checked="" type="checkbox"/> Load 1/2 enabled	As order code	Conf
Loop	Loop enable	<input type="checkbox"/> <input type="checkbox"/> Control Loop 1/2 disabled <input checked="" type="checkbox"/> <input checked="" type="checkbox"/> Control Loop 1/2 enabled	As order code	Conf
Math2 En1/En2/En3	Analogue (Maths) Operators	<input type="checkbox"/> <input type="checkbox"/> <input type="checkbox"/> <input type="checkbox"/> <input type="checkbox"/> <input type="checkbox"/> <input type="checkbox"/> <input type="checkbox"/> All 8 maths operators disabled <input checked="" type="checkbox"/> <input checked="" type="checkbox"/> <input checked="" type="checkbox"/> <input checked="" type="checkbox"/> <input checked="" type="checkbox"/> <input checked="" type="checkbox"/> <input checked="" type="checkbox"/> <input checked="" type="checkbox"/> All 8 maths operators enabled	As order code	Conf
MultiOper	Multi-input operator block	<input type="checkbox"/> <input type="checkbox"/> Multi-operator input disabled <input checked="" type="checkbox"/> <input checked="" type="checkbox"/> Multi-operator input enabled		Conf
Mux8	Multiplexor	<input type="checkbox"/> <input type="checkbox"/> <input type="checkbox"/> <input type="checkbox"/> All four multiplexors disabled <input checked="" type="checkbox"/> <input checked="" type="checkbox"/> <input checked="" type="checkbox"/> <input checked="" type="checkbox"/> All four multiplexors enabled		Conf
Poly	Polynomial linearisation block	<input type="checkbox"/> <input type="checkbox"/> Both polynomials disabled <input checked="" type="checkbox"/> <input checked="" type="checkbox"/> Both polynomials enabled		Conf
Progr	Programmer	<input type="checkbox"/> <input type="checkbox"/> Programmer 1/2 disabled <input checked="" type="checkbox"/> <input checked="" type="checkbox"/> Programmer 1/2 enabled		Conf

List Header: Inst		Sub-header: Enb (Enable)		
Name  to select	Parameter Description	Value Press  or  to change values	Default	Access Level
RTClock	Real time clock	<input type="checkbox"/> Real time clock disabled <input checked="" type="checkbox"/> Real time clock enabled		Conf
Switch	User switches	<input type="checkbox"/> <input type="checkbox"/> <input type="checkbox"/> <input type="checkbox"/> <input type="checkbox"/> <input type="checkbox"/> <input type="checkbox"/> <input type="checkbox"/> All 8 user switches disabled <input checked="" type="checkbox"/> <input checked="" type="checkbox"/> <input checked="" type="checkbox"/> <input checked="" type="checkbox"/> <input checked="" type="checkbox"/> <input checked="" type="checkbox"/> <input checked="" type="checkbox"/> <input checked="" type="checkbox"/> All 8 user switches enabled		Conf
SwOver	Switch over block	<input type="checkbox"/> Switch over block disabled <input checked="" type="checkbox"/> Switch over block enabled		Conf
Timer	Timers	<input type="checkbox"/> <input type="checkbox"/> <input type="checkbox"/> <input type="checkbox"/> All four timers disabled <input checked="" type="checkbox"/> <input checked="" type="checkbox"/> <input checked="" type="checkbox"/> <input checked="" type="checkbox"/> All four timers enabled	As order code	Conf
Totalise En	Totalisers	<input type="checkbox"/> <input type="checkbox"/> Both totalisers disabled <input checked="" type="checkbox"/> <input checked="" type="checkbox"/> Both totalisers enabled		Conf
TrScale	Transducer scaling	<input type="checkbox"/> <input type="checkbox"/> Both transducer inputs disabled <input checked="" type="checkbox"/> <input checked="" type="checkbox"/> Both transducer inputs enabled		Conf
UsrText	User text	<input type="checkbox"/> <input type="checkbox"/> <input type="checkbox"/> <input type="checkbox"/> <input type="checkbox"/> <input type="checkbox"/> <input type="checkbox"/> <input type="checkbox"/> All 8 user values disabled <input checked="" type="checkbox"/> <input checked="" type="checkbox"/> <input checked="" type="checkbox"/> <input checked="" type="checkbox"/> <input checked="" type="checkbox"/> <input checked="" type="checkbox"/> <input checked="" type="checkbox"/> <input checked="" type="checkbox"/> All 8 user values enabled		Conf
UsrVal En1 UsrVal En2	User values	<input type="checkbox"/> <input type="checkbox"/> <input type="checkbox"/> <input type="checkbox"/> <input type="checkbox"/> <input type="checkbox"/> <input type="checkbox"/> <input type="checkbox"/> All 8 user values disabled <input checked="" type="checkbox"/> <input checked="" type="checkbox"/> <input checked="" type="checkbox"/> <input checked="" type="checkbox"/> <input checked="" type="checkbox"/> <input checked="" type="checkbox"/> <input checked="" type="checkbox"/> <input checked="" type="checkbox"/> All 8 user values enabled		Conf
Zirconia	To enable the Zirconia function block. This is only available if ordered	<input type="checkbox"/> Zirconia block disabled <input checked="" type="checkbox"/> Zirconia block enabled		Conf



**Note:** The left most flag indicates the first instance e.g. Alarm1.

## 6.4 Instrument Options

This page allows you to set up options as listed in the following table:-

List Header: Inst		Sub-header: Opt (Options)			
Name ⌚ to select	Parameter Description	Value Press ⏴ or ⏵ to change values		Default	Access Level
Units	Instrument display units	C	° Celsius	C	Conf
		F	° Fahrenheit		
		K	° Kelvin		
ProgMode	<p>To select the type of programmer.</p> <p>☺ Ensure that two programmers are enabled (see previous section) otherwise only 'SingleChn' can be selected).</p>	SingleChn	Single channel (two independent channels)	SyncAll	Conf
		SyncAll	All segments of two programmer blocks are synchronised		
		SyncStart	Two programmers synchronised at start of run		
PVStart?	To enable PV Start. See Programmer section 22.15.	No Yes	Disabled Enabled	Disabled	Conf
ImmSP?	<p>When enabled, changes to the working setpoint (WSP) take effect immediately when adjusted using the front panel ⏴ or ⏵ buttons. (Note, when adjusted over comms the change always takes place immediately). The working setpoint may be derived from SP1, SP2 or a programmer setpoint - PSP*.</p> <p>Edits to the active setpoint usually take effect after the raise/lower button is released. It may be desirable, in some applications such as crystal growing, to eliminate this delay. This option also provides compatibility with other instruments such as the 818 or the 902 series.</p> <p>The effect is seen on Summary Pages, User Pages (when WSP is promoted) and in Program Status Page (when changing PSP in Hold).</p> <p>* If the working setpoint is derived from the programmer then the parameter 'ImmPSP' is shown in the programmer Run list in iTools only. This parameter can be hidden by disabling the parameter 'EnableImmPSP' which is shown in the programmer Setup list in iTools. These parameters are not shown in the user interface of 3500.</p>	No	Disabled - In operator level the new setpoint is entered after the raise/lower button is released and is indicated by a brief flash in the display	Disabled	Conf
		Yes	Enabled - In operator level the new setpoint is entered continuously and no flash of the display is shown.		













### 6.5 Display Formatting

The display which will be shown in Operator levels 1 to 3 may be customised. This is achieved in the 'Inst' configuration list using the sub-header 'Dis'.

#### 6.5.1 To Customise the Display

The controller must be in Configuration level. Then:-

Do This	The Display You Should See	Additional Notes
<ol style="list-style-type: none"> <li>1. Press  as many times as necessary until 'Inst' is displayed</li> <li>2. Press  or  to select 'Dis'</li> </ol>		<p>If a parameter from, say, the previous display is being shown, then it will be necessary to press  to return to the top of the list</p>
<ol style="list-style-type: none"> <li>3. Press  to scroll to the first parameter - 'Home Page'</li> <li>4. Press  or  to change the selection</li> </ol>		<p>In operator level the instrument, by default, shows 'Loop' parameters in the HOME display.</p> <p>The HOME display may also show:-</p> <ul style="list-style-type: none"> <li>Program Programmer parameters</li> <li>Custx Up to 8 views may be customised                             <ul style="list-style-type: none"> <li>Cust1 will select the first</li> </ul> </li> <li>Access Access parameters</li> </ul>
		<p>The following table shows the full list of parameters available to customise the display</p> <p style="text-align: center;"></p>

List Header: Inst		Sub-header: Dis (Display)			
Name ⌚ to select	Parameter Description	Value Press ⏴ or ⏵ to change values		Default	Access Level
Home Page	Configures which set of parameters are shown in the message display of the HOME view when the controller is in operator level.	Loop Program Custom 1 to 8 Access	Loop summary Program summary Customised Access	Loop	Conf
Home Timeout	In operator level the controller can be made to revert to the HOME display after a fixed time following selection of other pages	Off to 0:01 to 1:00 hr	Off = the controller will not revert to the HOME display	0:01 (1 min)	Conf
Loop Summary	A summary of the Loop parameters are displayed in the message centre (section 2.8.1.) in the selected operating level	On Off	Enabled Disabled	On	Conf
Loop 1 Summary	A summary of loop 1 parameters	On Off	Enabled Disabled	On	Conf
Loop 2 Summary	A summary of loop 2 parameters	On Off	Enabled Disabled	On	Conf
Prog Summary	A summary of the Program parameters are displayed in the message centre (section 2.8.1.) in the selected operating level	On Off	Enabled Disabled	On	Conf
Bar Scale Max	Upper limit of the vertical bar graph scale	-99999 to 99999		1372	Conf
Bar Scale Min	Lower limit of the vertical bar graph scale	-99999 to 99999		-200	Conf
Main Bar Val	Main bar graph value	This can be wired to any parameter. See also section 6.5.2.			L3
Aux1 Bar Val	First auxiliary bar graph value				L3
Aux2 Bar Val	Second auxiliary bar graph value				L3
Language	To select the language (when available)	English (French, German, Spanish)			Conf
Prog Edit	Defines the level in which a program may be edited	Level1 Level2 Level3		Level1	Conf
Control1 Page	Defines the level in which the control page 1 is shown	Off Level1		Level1	Conf
Control2 Page	Defines the level in which the control page 2 is shown	Level2			
Alarm Page	Defines the level in which the alarm page is shown				
Alarm Summary	Enables/disables the alarm summary page in operator levels	On Off	Enabled Disabled	On	Conf
OP1 Beacon	By default the output beacons are wired to operate when channel 1 or channel 2 outputs from the selected loop are active. They can, however, be wired to operate on any parameter.	Off	Beacon off		R/O
		On	Beacon on		
OP2 Beacon		Off	Beacon off		R/O
		On	Beacon on		
Txdr1 Page	Defines the level in which the Transducer 1 Scaling page is visible	Level 1 Level 2 Level 3		Level 1	Conf
Txdr2 Page	Defines the level in which the Transducer 2 Scaling page is visible	Level 1 Level 2 Level 3		Level 1	Conf

**6.5.2 Bar Graph (3504 Only)**

The bar graph shown on the left hand side of the display can be wired to any analogue parameter. The example shown in section 27.11.1 shows the bar graph wired to the main PV.

Markers can also be placed on the bar graph which can be used to indicate minimum and maximum points. These points are defined by the parameters 'Aux1 Bar Val' and 'Aux2 Bar Val' respectively. The markers may be fixed in position by leaving these two parameters unwired and entering an analogue value. Alternatively, they may be wired – in the following example they are wired to low and high alarm points.

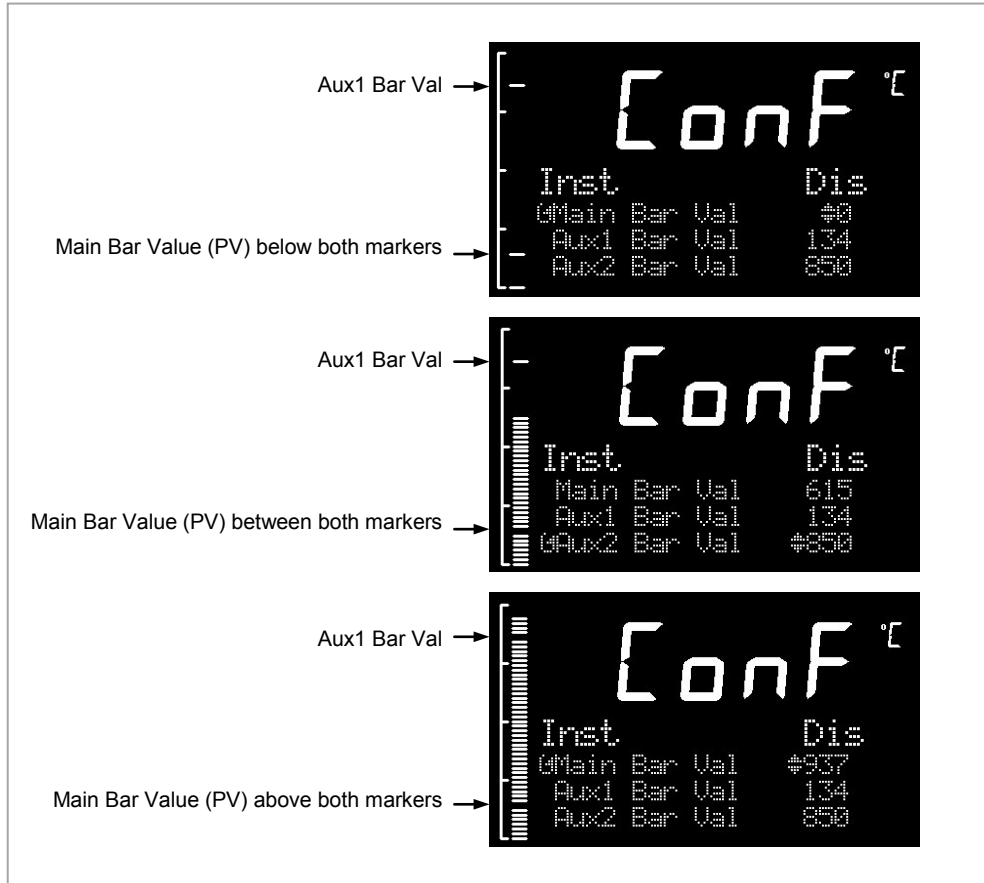

**Figure 6-2: Bar Graph Markers**

## 6.6 Instrument information

This list provides information about the controller as follows:-

List Header: Inst	Sub-header: Inf
Name  to select	Parameter Description
Inst Type	The type of instrument e.g., 3504, can be used over comms to identify the instrument being communicated with
Version Num	The version of instrument software. Can be used to identify the build of software being used and hence what features are available. If an upgrade is performed, this will be updated and the instrument non volatile ram will be re-initialised.
Serial Num	The unique serial number of the instrument. This is set at the factory and cannot be changed.
Passcode1	Codes required to remotely upgrade the controller cost options
Passcode2	Codes required to remotely upgrade the controller cost options
Passcode3	Codes required to remotely upgrade the controller cost options
Company ID	A Modbus code allocated to Eurotherm

## 6.7 Instrument Diagnostics

This list provides fault finding diagnostic information as follows:-

List Header: Inst	Sub-header: Dia	
Name	Parameter Description	
 to select		
CPU % Free	This is the amount of free CPU Time left. It shows the percentage of the tasks ticks that are idle.	
CPU % Min	A benchmark of the lowest reached value of the CPU free percentage.	
Con Ticks	This is the number of ticks that have elapsed while the instrument was performing the control Task.	
Max Con Tick	A benchmark of the maximum number of ticks that have elapsed while the instrument was performing the control Task	
UI Ticks	This is the number of ticks that have elapsed while the instrument was performing the user interface Task.	
Max UI Ticks	A benchmark of the maximum number of ticks that have elapsed while the instrument was performing the user interface Task	
Clear Stats	Resets the instrument performance bench marks.	
Power FF	The measurement of the instrument line voltage. Power feedforward can be enabled by setting the parameter 'Pff En' in the Loop Output list (section 21.8.1) to 'Yes'. This sets the control loop PFF Value parameter such that the control algorithm can compensate for mains voltage fluctuations when the instrument is connected to the same phase as the heater.	
A/Man Key	The purpose of these parameters is to allow the functions to be wired to, for example, a digital input so that the function can be controlled from an external source.	
Prog Key		
Run/Hold Key		
Error Count	The number of errors logged since the last Clear Log. Note however, that if an error occurs multiple times only the first occurrence will be logged, but each event will increment the count.	
Error 1 to Error 8	The first 8 errors to occur	<a href="#">See Note</a> below for options
Clear Log	Clears the error log entries and count.	
String Count	Number of User Strings Defined	
String Space	Space Available For User Strings.	
Segments Left	Number of Available Program Segments Gives the number of unused program segments. Each time a segment is allocated to a program, this value is reduced by one.	
Ctl Stack Free	Control Stack Free Space (words) The number of words of un-used stack for the control task	
Comms Stack Free	Comms Stack Free Space (words) The number of words of un-used stack for the comms task	
UI Stack Free	HMI Stack Free Space (words) The number of words of un-used stack for the HMI task	
Idle Stack Free	Idle Stack Free Space (words) The number of words of un-used stack for the idle (background) task.	
Max.Inst Segs	Displays the maximum number of program segments – 500 (read only)	
Segs Per Prog	Displays the maximum number of segments available in any program – 50 (read only)	
Cntr1 Overrun	This is a flag which is set if the tick rate exceeds 110ms	
Pwr Fail Count	This counts the number of times that the controller has been powered down	
Cust1 to Cust3 Name	This displays the name of the table downloaded or 'No tbl' if none is loaded	

**Note:**

- 0: There is no error
- 1: Bad or unrecognised module ident. A module has been inserted and has a bad or unrecognised ident, either the module is damaged or the module is unsupported.
- 3: Factory calibration data bad. The factory calibration data has been read from an I/O module and has not passed the checksum test. Either the module is damaged or has not been initialised.
- 4: Module changed for one of a different type. The configuration may now be incorrect
- 5: I/O Chip DFC1 communication failure. The onboard generic I/O Chip DFC1 will not communicate. This could indicate a build fault in the instrument.
- 6: I/O Chip DFC2 communication failure. The onboard generic I/O Chip DFC2 will not communicate. This could indicate a build fault in the instrument.
- 7: I/O Chip DFC3 communication failure. The onboard generic I/O Chip DFC3 will not communicate. This could indicate a build fault in the instrument.
- 10: Calibration data write error. An error has occurred when attempting to write calibration data back to an I/O module's EE.
- 11: Calibration data write error. An error occurred when trying to read calibration data back from the EE on an I/O module.
- 13: Fixed PV input error. An error occurred whilst reading data from the fixed PV Input EE.
- 18: Checksum error. The checksum of the NVol RAM has failed. The NVol is considered corrupt and the instrument configuration may be incorrect.
- 20: Resistive identifier error. An error occurred when reading the identifier from an I/O module. The module may be damaged.
- 21: Fixed PV ident has been changed. This may be due to installation of new Power Supply Board.
- 22: Module 1 changed for one of a different type. The configuration may now be incorrect
- 23: Module 2 changed for one of a different type. The configuration may now be incorrect
- 24: Module 3 changed for one of a different type. The configuration may now be incorrect
- 25: Module 4 changed for one of a different type. The configuration may now be incorrect
- 26: Module 5 changed for one of a different type. The configuration may now be incorrect
- 27: Module 6 changed for one of a different type. The configuration may now be incorrect
- 28: H Module changed for one of a different type. The configuration may now be incorrect
- 29: J Module changed for one of a different type. The configuration may now be incorrect
- 43: Invalid custom linearisation table. One of the custom linearisation tables is invalid. Either it has failed checksum tests or the table downloaded to the instrument is invalid.
- 55: Instrument wiring invalid or corrupt.
- 56: Non Vol write to volatile. An attempt was made to perform a checksummed Non Vol write to a non checksummed address.
- 58: Recipe load failure. The selected recipe failed to load.
- 62: Max Wire Limit reached. Using Quick Start the maximum number of wires has been reached
- 78: Corrupted User Page. A corruption of one or more configured user pages has been detected

## 7. Chapter 7 Process Input

The process input list characterises and ranges the signal from the input sensor. The Process Input parameters provide the following features:-



Input Type and linearisation	Thermocouple (TC) and 3-wire resistance thermometer (RTD) temperature detectors  Volts, mV or mA input through external shunt or voltage divider, available with linear, square root or custom linearisation  See the table in section 7.2.1 for the list of input types available
Display units and resolution	The change of display units and resolution will apply to all the parameters related to the process variable
Input filter	First order filter to provide damping of the input signal. This may be necessary to prevent the effects of excessive process noise on the PV input from causing poor control and indication. More typically used with linear process inputs.
Fault detection	Sensor break is indicated by an alarm message 'Sbr'. For thermocouple it detects when the impedance is greater than pre-defined levels; for RTD when the resistance is less than 12Ω.
User calibration	Either by simple offset or by slope and gain. See section 7.2.6 for further details.
Over/Under range	When the input signal exceeds the input span by more than 5% the PV is shown as 'HHHHH' or 'LLLLL'. The check is executed twice: before and after user calibration and offset adjustments. The same indications apply when the display is not able to show the PV, for example, when the input is greater than 9999.9°C with one decimal point.

### 7.1 To select PV Input

Select Level 3 or Configuration level as described in Chapter 3.

Then press  as many times as necessary until the header 'PVInput' is displayed

### 7.2 Process Input Parameters

List Header - PV Input		Sub-headers: None			
Name  to select	Parameter Description	Value Press  or  to change values		Default	Access Level
IO Type	PV input type. Selects input linearisation and range	ThermoCpl	Thermocouple		Conf R/O L3
		RTD	Platinum resistance thermometer		
		Log10	Logarithmic		
		HZ Volts	High impedance voltage input (typically used for zirconia probes)		
		Volts	Voltage		
		mA	milli amps		
		80mV	80 milli volts		
		40mV	40 milli volts		
		Pyrometer	Pyrometer		
Lin Type	Input linearisation	see section 7.2.1.			Conf R/O L3
Units	Display units used for units conversion	see section 7.2.3.			Conf
Res'n	Resolution	XXXXX to X.XXXX			Conf
CJC Type	To select the cold junction compensation method Only appears if IO Type = Thermocouple	Internal 0°C 45°C 50°C External Off	See description in section 7.2.2. for further details	Internal	Conf
SBrk Type	Sensor break type	Low	Sensor break will be detected when its impedance is greater than a 'low' value		Conf

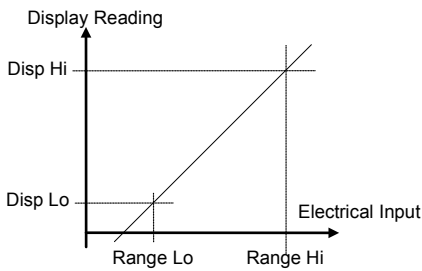
List Header - PV Input		Sub-headers: None			
Name Ⓞ to select	Parameter Description	Value Press ▼ or ▲ to change values		Default	Access Level
		High	Sensor break will be detected when its impedance is greater than a 'high' value		
		Off	No sensor break		
SBrk Alarm	Sets the alarm action when a sensor break condition is detected	ManLatch	Manual latching	see also the alarm Chapter 12 Alarms	L3
		NonLatch	No latching		
		Off	No sensor break alarm		
SBrk Out	Sensor break alarm status	Off or On			L3 R/O
Disp Hi	Configures the maximum displayable reading.	see also section 7.2.6. These parameters only appear for V, mV, mA input types 			L3
Disp Lo	Configures the minimum displayable reading.				L3
Range Hi	Configures the maximum (electrical) input level.				L3
Range Lo	Configures the minimum (electrical) input level				L3
Fallback	Fallback Strategy See also section 7.2.5.	Downscale	Meas Value = Input range lo - 5% of the mV signal received from the PV input.		Conf
		Upscale	Meas Value = Input range Hi + 5% of the mV signal received from the PV input.		
		Fall Good	Meas Value = Fallback PV		
		Fall Bad	Meas Value = Fallback PV		
		Clip Good	Meas Value = Input range Hi/lo +/- 5%		
		Clip Bad	Meas Value = Input range Hi/lo +/- 5%		
Fallback PV	Fallback value. See also section 7.2.5.	Instrument range			Conf
Filter Time	Input filter time. An input filter provides damping of the input signal. This may be necessary to prevent the effects of excessive noise on the PV input.	Off to 500:00 (hhh:mm) m:ss.s to hh:mm:ss to hhh:mm		0:01.6	L3
Emiss	Emissivity. Used for Pyrometer input only to compensate for the different reflectivity produced by different type of surface	Off 0.1 to 1.0		1.0	L3
Meas Value	The current electrical value of the PV input				R/O
PV	The current value of the PV input after linearisation	Instrument range			R/O
Offset	Used to add a constant offset to the PV see section 0.	Instrument range			L3
Lo Point	Allows a two point offset to be applied to the controller to compensate for sensor or connection errors between sensor and the input to the controller. See section 7.2.8 for further details	Instrument range			L3
Lo Offset					
Hi Point					
Hi Offset					
CJC Temp	Reads the temperature of the rear terminals at the thermocouple connection Only appears if IO Type = Thermocouple				L3 R/O
SBrk Value	Sensor break Value Used for diagnostics only, and displays the sensor break trip value				R/O
Lead Res	The measured lead resistance on the RTD Only appears if IO Type = RTD				R/O



List Header - PV Input		Sub-headers: None			
Name ⊙ to select	Parameter Description	Value Press ▼ or ▲ to change values		Default	Access Level
Cal State	Calibration state Calibration of the PV Input is described in Chapter 26.	Idle			Conf L3 R/O
Status	PV Status The current status of the PV.	OK (0)	Normal operation		R/O
		StartUp (1)	Initial startup mode		
		Sbreak (2)	Input in sensor break		
		Out Of Range (3)	PV outside operating limits		
		Saturated (4)	Saturated input		
		Not Calibrated (5)	Uncalibrated channel		

### 7.2.1 Input Types and Ranges

Used to select the linearisation algorithm required by the input sensor.

A selection of default sensor linearisations are provided for thermocouples/RTD's and Pyrometers.

If linearisation type is linear a  $y=mx+c$  relationship is applied between DisplayHigh/DisplayLow and RangeHigh/RangeLow.

Three custom tables may be configured by downloading an appropriate table from an extensive library

Input Type		Min Range	Max Range	Units	Min Range	Max Range	Units
J	Thermocouple type J	-210	1200	°C	-346	2192	°F
K	Thermocouple type K	-200	1372	°C	-328	2502	°F
L	Thermocouple type L	-200	900	°C	-328	1652	°F
R	Thermocouple type R	-50	1768	°C	-58	3214	°F
B	Thermocouple type B	0	1820	°C	32	3308	°F
N	Thermocouple type N	-200	1300	°C	-328	2372	°F
T	Thermocouple type T	-200	400	°C	-328	752	°F
S	Thermocouple type S	-50	1768	°C	-58	3215	°F
PL2	Platinell	0	1369	°C	32	2496	°F
C	Thermocouple type C						
PT100	Pt100 resistance thermometer	-200	850	°C	-328	1562	°F
Linear	mV or mA linear input	-10.00	80.00				
SqRoot	Square root						
Tbl 1	Customised linearisation table 1						
Tbl 2	Customised linearisation table 2						
Tbl 3	Customised linearisation table 3						

## 7.2.2 CJC Type

A thermocouple measures the temperature difference between the measuring junction and the reference junction. The reference junction, therefore, must either be held at a fixed known temperature or accurate compensation be used for any temperature variations of the junction.

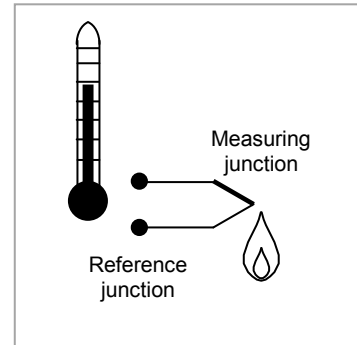

### 7.2.2.1 Internal Compensation

The controller is provided with a temperature sensing device which senses the temperature at the point where the thermocouple is joined to the copper wiring of the instrument and applies a corrective signal.

Where very high accuracy is needed and to accommodate multi-thermocouple installations, larger reference units are used which can achieve an accuracy of  $\pm 0.1^\circ\text{C}$  or better. These units also allow the cables to the instrumentation to be run in copper. The reference units are contained basically under three techniques. Ice-Point, Hot Box and Isothermal

### 7.2.2.2 The Ice-Point

There are usually two methods of feeding the EMF from the thermocouple to the measuring instrumentation via the ice-point reference. The bellows type and the temperature sensor type.

The bellows type utilises the precise volumetric increase which occurs when a known quantity of ultra pure water changes state from liquid to solid. A precision cylinder actuates expansion bellows which control power to a thermoelectric cooling device. The temperature sensor type uses a metal block of high thermal conductance and mass, which is thermally insulated from ambient temperatures. The block temperature is lowered to  $0^\circ\text{C}$  by a cooling element, and maintained there by a temperature sensing device.

Special thermometers are obtainable for checking the  $0^\circ\text{C}$  reference units and alarm circuits that detect any movement from the zero position can be fitted.

### 7.2.2.3 The Hot Box

Thermocouples are calibrated in terms of EMF generated by the measuring junctions relative to the reference junction at  $0^\circ\text{C}$ . Different reference points can produce different characteristics of thermocouples, therefore referencing at another temperature does present problems. However, the ability of the hot box to work at very high ambient temperatures, plus a good reliability factor has led to an increase in its usage. The unit can consist of a thermally insulated solid aluminium block in which the reference junctions are embedded.

The block temperature is controlled by a closed loop system, and a heater is used as a booster when initially switching on. This booster drops out before the reference temperature, usually between  $55^\circ\text{C}$  and  $65^\circ\text{C}$ , is reached, but the stability of the hot box temperature is now important. Measurements cannot be taken until the hot box reaches the correct temperature.

### 7.2.2.4 Isothermal Systems

The thermocouple junctions being referenced are contained in a block which is heavily thermally insulated. The junctions are allowed to follow the mean ambient temperature, which varies slowly. This variation is accurately sensed by electronic means, and a signal is produced for the associated instrumentation. The high reliability factor of this method has favoured its use for long term monitoring.

### 7.2.2.5 CJC Options in 3500 Series

- 0: CJC measurement at instrument terminals
- 1: CJC based on external junctions kept at  $0^\circ\text{C}$  (Ice Point)
- 2: CJC based on external junctions kept at  $45^\circ\text{C}$  (Hot Box)
- 3: CJC based on external junctions kept at  $50^\circ\text{C}$  (Hot Box)
- 4: CJC based on independent external measurement
- 5: CJC switched off

### 7.2.3 Display Units

None

Abs Temp °C/°F/°K,

V, mV, A, mA,

PH, mmHg, psi, Bar, mBar, %RH, %, mmWG, inWG, inWW, Ohms, PSIG, %O2, PPM, %CO2, %CP, %/sec,

RelTemp °C/°F/°K(rel)\*,

Vacuum

sec, min, hrs,

- RelTemp (Relative Temperature) may be used when measuring differential temperatures. It informs the controller not to add or subtract 32 when changing between °C and °F.

### 7.2.4 Sensor Break Value

The controller continuously monitors the impedance of a transducer or sensor connected to any analogue input (including plug in modules). This impedance, expressed as a percentage of the impedance which causes the sensor break flag to trip, is a parameter called 'SBrk Trip Imp' and is available in the parameter lists associated with both Standard and Module inputs of an analogue nature.

The table below shows the typical impedance which causes sensor break to trip for various types of input and high and low 'SBrk Impedance parameter settings. The impedance values are only approximate ( $\pm 25\%$ ) as they are not factory calibrated.

<b>PV Input (Also applies to the Analogue Input module)</b>			
<b>mV input (<math>\pm 40\text{mV}</math> or <math>\pm 80\text{mV}</math>)</b>		<b>Volts (<math>\pm 10\text{V}</math>)</b>	
SBrk Impedance – High	~ 12K $\Omega$		
SBrk Impedance - Low	~ 3K $\Omega$		
<b>Volts input (-3V to +10V) and HZ Volts input (-1.5 to 2V)</b>			
SBrk Impedance – High		~ 20K $\Omega$	
SBrk Impedance - Low		~ 5K $\Omega$	

### 7.2.5 Fallback

A Fallback strategy may be used to configure the default value for the PV in case of an error condition. The error may be due an out of range value, a sensor break, lack of calibration or a saturated input.

The Status parameter would indicate the error condition and could be used to diagnose the problem.

Fallback has several modes and may be associated with the Fallback PV parameter

The Fallback PV may be used to configure the value assigned to the PV in case of an error condition.

The Fallback parameter should be configured accordingly.

The fallback parameter may be configured so as to force a Good or Bad status when in operation. This in turn allows the user to choose to override or allow error conditions to affect the process.

### 7.2.6 PV Input Scaling

PV input scaling applies to the linear mV input range only. This is set by configuring the 'IO Type' parameter to 40mV, 80mV, mA, Volts or HZVolts. Using an external burden resistor of 2.49Ω, the controller can be made to accept 4-20mA from a current source. Scaling of the PV input will match the displayed reading to the electrical input levels from the transducer. PV input scaling can only be adjusted in configuration level and is not provided for direct thermocouple, pyrometer or RTD inputs.

The graph below shows an example of input scaling, where it is required to display 75.0 when the input is 4mV and 500.0 when the input is 20mV .

If the input exceeds  $\pm 5\%$  of the Range Lo or Range Hi settings, sensor break will be displayed.

For mA inputs  
 4-20mA = 9.96-49.8mV with 2.49Ω load resistor  
 0-20mA = 0-49.8mV with 2.49Ω load resistor  
 mA input will detect sensor break if mA < 3mA  
 Use a current source to remove shunt resistor errors

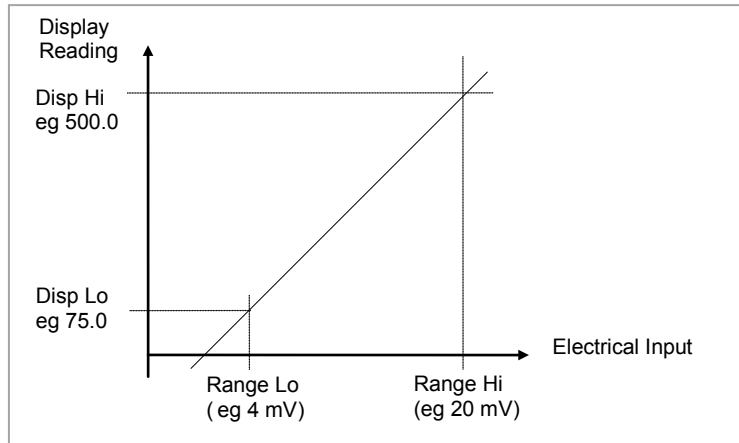

Figure 7-1: PV Input Scaling

#### 7.2.6.1 Example: To Scale a Linear Input:-

Do This	The Display You Should See	Additional Notes
1. Select Conf as described in Chapter 3. Then press  to select 'PVInput'	<pre>PVInput @IO Type      #mA Lin Type      Linear Units         None</pre>	
2. Press  to scroll to 'IO Type'	<pre>PVInput IO Type       mA @Lin Type     #Linear Units         None</pre>	Linearisation type and resolution should also be set as appropriate.
3. Press  or  to 'mA', 'Volts' or mV		
4. Press  to scroll to 'Disp Hi'	<pre>PVInput SBrk Type     Low SBrk Alarm    NonLatch @Disp Hi     #500.0</pre>	Resolution set to XXXX.X in this example
5. Press  or  to '500.00'		
6. Press  to scroll to 'Disp Lo'	<pre>PVInput SBrk Alarm    NonLatch Disp Hi       500.0 @Disp Lo     #75.0</pre>	
7. Press  or  to '75.00'		
8. Press  to scroll to 'Range Hi'	<pre>PVInput Disp Hi       500.0 Disp Lo       75.0 @Range Hi     #20.000</pre>	The controller will read 500.0 for a mA input of 20.00
9. Press  or  to '20.000'		
10. Press  to scroll to 'Range Lo'	<pre>PVInput Disp Lo       75.0 Range Hi      20.000 @Range Lo     #4.000</pre>	The controller will read 75.0 for a mA input of 4.00
11. Press  or  to '4.000'		

**7.2.7 PV Offset**

All ranges of the controller have been calibrated against traceable reference standards. This means that if the input type is changed it is not necessary to calibrate the controller. There may be occasions, however, when you wish to apply an offset to the standard calibration to take account of known errors within the process, for example, a known sensor error or a known error due to the positioning of the sensor. In these instances it is not advisable to change the reference calibration, but to apply a user defined offset.

It is also possible to apply a two point offset and this is described in the next section.

PV Offset applies a single offset over the full display range of the controller and can be adjusted in Level 3. It has the effect of moving the curve up a down about a central point as shown in the example below:-

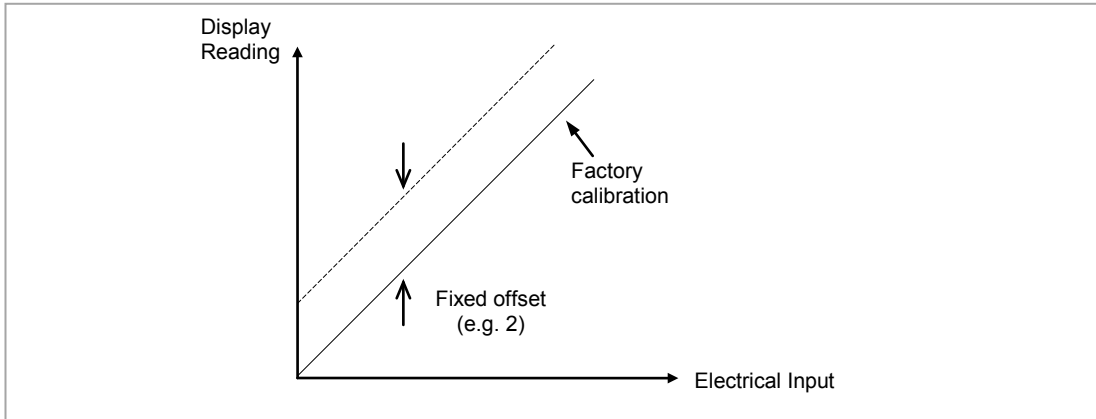

**Figure 7-2: PV Offset**

**7.2.7.1 Example: To Apply an Offset:-**

- Connect the input of the controller to the source device which you wish to calibrate to
- Set the source to the desired calibration value
- The controller will display the current measurement of the value
- If the display is correct, the controller is correctly calibrated and no further action is necessary. If you wish to offset the reading:-

Do This	The Display You Should See	Additional Notes
1. Select Level 3 or Conf as described in Chapter 3. Then press  to select 'PVInput'		
2. Press  to scroll to 'Offset'		In this case an offset of 2.0 units is applied
3. Press  or  to adjust the offset to the reading you require		

### 7.2.8 Two Point Offset

A two point offset enables the controller display to be offset by different amounts at the low end of the scale and at the high end of the scale. The basic calibration of the controller is unaffected but the two point offset provides a compensation for sensor or inter-connection errors. The diagrams below show that a line is drawn between the low and high offsets values. Any readings above and below the calibration points will be an extension of this line. For this reason it is best to calibrate with the two points as far apart as possible.

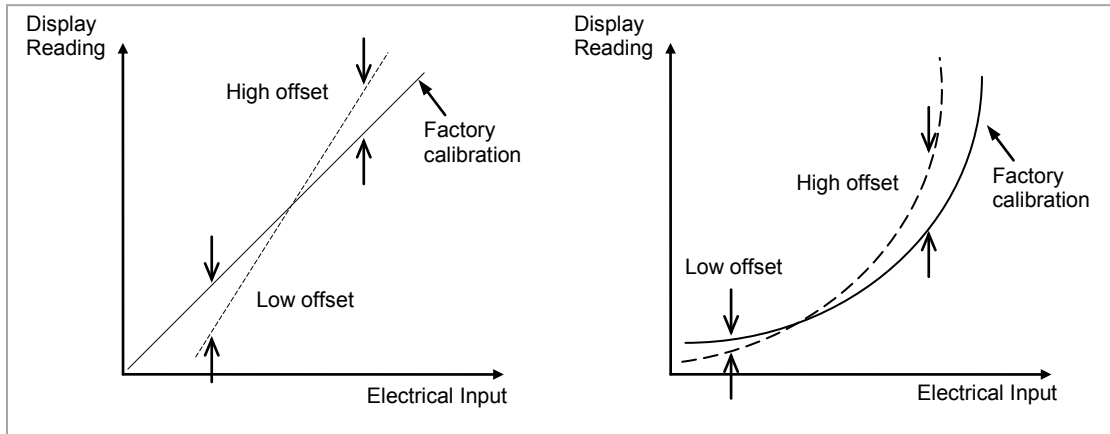

Figure 7-3: Two Point Offsets

#### 7.2.8.1 Example: To Apply a Two Point Offset:-

For this example it is assumed that an input of 0.0 mV produces a reading of 0.0 and an input of 80.0mV produces a reading of 1000.0.

- Connect the input of the controller to the source device which you wish to calibrate to
- With the source set to its low output set the 'Lo Point' to 0. This defines the low point at which you wish to calibrate the sensor to the controller. Set 'Lo Offset' until the display reads as required.
- With the source set to its high output set the 'Hi Point' to 1000. This defines the high point at which you wish to calibrate the sensor to the controller. Set 'Hi Offset' until the display reads as required.

## 8. Chapter 8 Logic Input/Output

There are two logic IO channels, standard on all controllers, which may be configured independently as inputs or outputs. Connections are made to terminals LA and LB, with LC as the common for both. Parameters in the 'LgcIO' lists allow each IO to be configured independently under the sub-headers LA and LB.

 **Warning:** The two IO are not isolated from each other since they share a common return.



The logic IO channels can also be used as a transmitter power supply as described in section 1.6.2.

### 8.1 To select Logic IO list

Select Level 3 or Configuration level as described in Chapter 3.

Then press  as many times as necessary until the header 'LgcIO' is displayed.

### 8.2 Logic IO Parameters



List Header - LgcIO		Sub-header - LA and LB			
Name  to select	Parameter Description	Value Press  or  to change values		Default	Access Level
IO Type	To configure the type of input or output	Input	Logic input	Input	Conf R/O L3
		ContactCl	Contact closure input		
		OnOff	On off output		
		Time Prop	Time proportioning output		
		ValvRaise <a href="#">See Note 1</a>	Motorised valve position output – raise on LA only		

 **Note 1:** LA and LB work in a complementary manner in Valve Positioning (VP) applications. When LA is set to ValvRais LB is automatically set to ValvLowr. IOType for LB is NOT alterable in VP applications. Configuration settings applied to LA will be applied to LB automatically.

Summary of parameters which follow 'IO Type' for different configurations of Input or Output:-

Input	ContactCl	OnOff	Time Prop	ValvRaise
Invert	Invert	Invert	Cycle Time	Min OnTime
PV	PV	SbyAct	Min OnTime	
		Meas Val	Res'n	SbyAct
		PV	Disp Hi	Meas Val
			Disp Lo	PV
			Range Hi	Inertia
			Range Lo	Backlash
			SbyAct	Cal State
			Meas Val	
			PV	

Explanation of Logic IO Parameters:-

List Header - LgcIO		Sub-header - LA and LB			
Name  to select	Parameter Description	Value Press  or  to change values		Default	Access Level
PV	When configured as an output, this is the desired output value	0 to 100			L3
	When configured as an input the current state of the digital input is displayed	0 to 1 (OnOff)			

List Header - LgcIO		Sub-header - LA and LB			
Name Ⓞ to select	Parameter Description	Value Press ⏴ or ⏵ to change values		Default	Access Level
Invert	Sets the sense of the logic input or on/off output. Does not apply if the IO Type is Time Prop or ValvRaise.	No	Non inverted. Output off (logic 0) when PID demand off. For control this is when PV>SP. Output on (logic 1) when PID demand off. For control this is when PV<SP. This is the normal setting for control.	No	Conf
		Yes	Inverted Output off (logic 0). For an alarm this is when the alarm is active. Output on (logic 1). For an alarm this is when the alarm is in-active. This is the normal setting for alarms.		
The next six parameters are only shown when 'IO Type' = 'Time Prop' outputs					
Cycle Time  See also section 8.2.2.	Allows the output to be switched on and off within the set time period. Applies only to an output type configured as Time Proportioning.	Off or 0.01 to 60.00 seconds	When Off is selected the Min OnTime algorithm will run. When set to any other value the CycleTime algorithm will run.	Off	L3
Min OnTime  See also section 8.2.2.	The minimum time (in seconds) that the relay is on or off. Applies only to an output type configured as Time Proportioning or ValvRaise and is only available when 'Cycle Time' = Off	Auto 0.01 to 150.00 seconds	If set to Auto the minimum on time will be 110mS. If the logic is used to control an external relay, Min OnTime should be set to a minimum of (say) 10 seconds to prevent the relay from switching too rapidly.	Auto	L3
Res'n	Display resolution. This sets the number of decimal places displayed by Disp Hi and Disp Lo parameters	XXXXX XXXX.X XXX.XX XX.XXX X.XXXX	No decimal points One decimal point Two decimal points Three decimal points Four decimal points	XXXXX	Conf
Disp Hi	The maximum displayable reading	0.000 to 100.000	These parameters allow high and low limits to be applied to the output against a set limit of the output demand signal from the PID loop. See also section 10.4.3 for further information	100.00	L3
Disp Lo	The minimum displayable reading	0.000 to 100.000		0.00	L3
Range Hi	The maximum (electrical) input/output level	0.00 to 100.00		L3	
Range Lo	The minimum (electrical) input/output level	0.00 to 100.00		L3	
SbyAct  See also section 8.2.1.	Standby action. Determines the action of an output when the instrument is in Standby Mode.	Off	The output will drive to 'electrical low' value regardless of the 'Invert' parameter.	Off	Conf R/O L3
		On	The output will drive to 'electrical high' value regardless of the 'Invert' parameter.		
		Cont	The output will assume a status according to how it is driven		
		For motor valve outputs the options are:-			
		Frz	Freeze – only shown if the output is configured for valve position control		
		Cont	Continue - only shown if the output is configured for valve position control		
Meas Val	The current value of the output demand signal	0 1	On (unless Invert = Yes) Off (unless Invert = Yes)		L3 R/O
The following parameters are additional if 'IO Type' = 'Valve Rais'					
Inertia	Set this parameter to match the inertia (if any) of the motor	0.0 to 9999.9 secs	0.0		L3
Backlash	Compensates for any backlash which may be present in the linkages	0.0 to 9999.9 secs	0.0		L3



List Header - LgcIO		Sub-header - LA and LB		
Name ⌂ to select	Parameter Description	Value Press ⏴ or ⏵ to change values	Default	Access Level
Cal State See also section 8.2.4.	Calibration status This is only applicable to valve position outputs	Idle Raise Lower		L3

PV can be wired to the output of a function block. For example if it is used for control it may be wired to the control loop output (Ch1 Output) as shown in the example in section 5.1.1.

### 8.2.1 Output State When the Controller is in Standby

The output strategy of **all digital outputs** may be defined using 'SbyAct'. The strategy depends on the use to which the output is configured, for example, if it is an alarm it may be required to turn the output on or to continue normal operation when the controller is in standby. For a control output the strategy may be to turn the output off when in standby.

There are three possible states:-

**Off** - The output will drive to 'electrical low' value regardless of the 'Invert' parameter.

**On** - The output will drive to 'electrical high' value regardless of the 'Invert' parameter.

**Continue** - The output will assume a status according to how it is driven:

- If locally wired, the output will continue to be driven by the wire.
- If not wired or driven by communications, the output will maintain the last state written to it
- If not wired but written to by communications, the output will continue to be controlled by the communications messages. In this case care should be taken to allow for the loss of communications.

For motor valve outputs the options are:-

**Freeze** - The valve outputs will both stop driving in standby.

**Continue** - The valve outputs will assume a status according to how they are driven:

- If locally wired, the output will continue to be driven by the wire.
- If not wired or driven by communications, the output will maintain the last state written to it
- If not wired but written to by communications, the output will continue to be controlled by the communications messages. In this case care should be taken to allow for the loss of communications.

### 8.2.2 Cycle Time and Minimum OnTime Algorithms

The 'Cycle Time' algorithm has been added from firmware version 2.70.

The 'Cycle Time' algorithm and the 'Min OnTime' algorithm are mutually exclusive and provide compatibility with existing controller systems. Both algorithms apply to time proportioning outputs only and are not shown for on/off control. The 'Min OnTime' parameter is only displayed when the 'Cycle Time' is set to Off.

A fixed cycle time allows the output to switch on and off within the time period set by the parameter. For example, for a cycle time of 20 seconds, 25% power demand would turn the output on for 5 seconds and off for 15 seconds, 50% power demand would turn the output on and off for 10 seconds, for 75% power demand the output is on for 15 seconds and off for 5 seconds.

Fixed cycle time may be preferred when driving mechanical devices such as refrigeration compressors.

The 'Min OnTime' algorithm allows a limit to be applied to the switching device so that it remains on (or off) for a set minimum time. When set to Auto, the minimum pulse time that can be set is 110ms. A very low power demand is represented by a short on pulse of 110ms duration followed by a correspondingly long off time. As the power demand increases the on pulse becomes longer and the off pulse becomes correspondingly shorter. For a 50% power demand the on and off pulse lengths are the same (at 220ms on and 220ms off). Setting to Auto is suitable for triac or logic outputs, not driving a mechanical device.

If the control device is a relay or contactor the minimum on time should be set greater than 10 seconds (for example) to prolong relay life. By way of illustration, for a setting of 10 seconds the relay will switch (approximately) as shown in the table below:-

Power demand	Relay ON time (seconds)	Relay OFF time (seconds)
10%	10	100
25%	13	39
50%	20	20
75%	39	13
90%	100	10

The Minimum OnTime algorithm is often preferred for control of switching devices using triac, logic or relay outputs in a temperature control application. It also applies to valve position outputs - see also section 21.8.9.

### 8.2.3 Example: To Configure a Time Proportioning Logic Output







Select configuration level as described in section 3.3.

Then:-

Do This	The Display You Should See	Additional Notes
<ol style="list-style-type: none"> <li>From any display press  until the 'LgcIO' page is reached</li> <li>Press  or  as necessary to select 'LA' or 'LB'</li> <li>Press  to scroll to 'IO Type'</li> <li>Press  or  to 'Time Prop'</li> </ol>	 <pre> LgcIO LA IO Type #Time Prop Invert No Min OnTime Auto           </pre>	

### 8.2.4 Example: To Calibrate a VP Output

The 'Cal State' parameter in this list allows you to fully open or fully close the valve when it is required to calibrate a feedback potentiometer used with a bounded VP control.

Do This	The Display You Should See	Additional Notes
<ol style="list-style-type: none"> <li>From the 'LgcIO' 'LA' page, press  to scroll to 'Cal State'</li> <li>Press  or  to select 'Raise'</li> </ol>	 <pre> LgcIO LA IO Type #ValvRais Invert No Min OnTime Auto  LgcIO LA Inertia 0.0 Backlash 0.0 @Cal State #Idle  LgcIO LA Inertia 0.0 Backlash 0.0 @Cal State #Raise           </pre>	The loop is temporarily disconnected to allow the valve to drive fully open.
<ol style="list-style-type: none"> <li>Now select the page header which contains the Potentiometer Input module</li> </ol>		
<ol style="list-style-type: none"> <li>Press  to scroll to 'Cal State' in the <b>Potentiometer list</b> - section 10.3.9.</li> </ol>		
<ol style="list-style-type: none"> <li>Press  or  to select 'Hi'. Then 'Confirm'. The controller will automatically calibrate to the potentiometer position. The messages 'Go' and 'Busy' will be displayed during this time. If successful the message 'Passed' will be displayed and if unsuccessful 'Failed' will be displayed. A fail could be due to the potentiometer value being out of range. See also section 10.4.5.</li> </ol>		
<ol style="list-style-type: none"> <li>Drive the valve fully closed using 'Lower' in the 'LgcIO' page. Then repeat 3, 4 and 5 for the 'Lo' calibration point</li> </ol>		

### 8.2.5 Logic Output Scaling

If the output is configured for time proportioning control, it can be scaled such that a lower and upper level of PID demand signal can limit the operation of the output value.

By default, the output will be fully off for 0% power demand, fully on for 100% power demand and equal on/off times at 50% power demand. You can change these limits to suit the process. It is important to note, however, that these limits are set to safe values for the process. For example, for a heating process it may be required to maintain a minimum level of temperature. This can be achieved by applying an offset at 0% power demand which will maintain the output on for a period of time. Care must be taken to ensure that this minimum on period does not cause the process to overheat.

If Range Hi is set to a value <100% the time proportioning output will switch at a rate depending on the value - it will not switch fully on.

Similarly, if Range Lo is set to a value >0% it will not switch fully off.

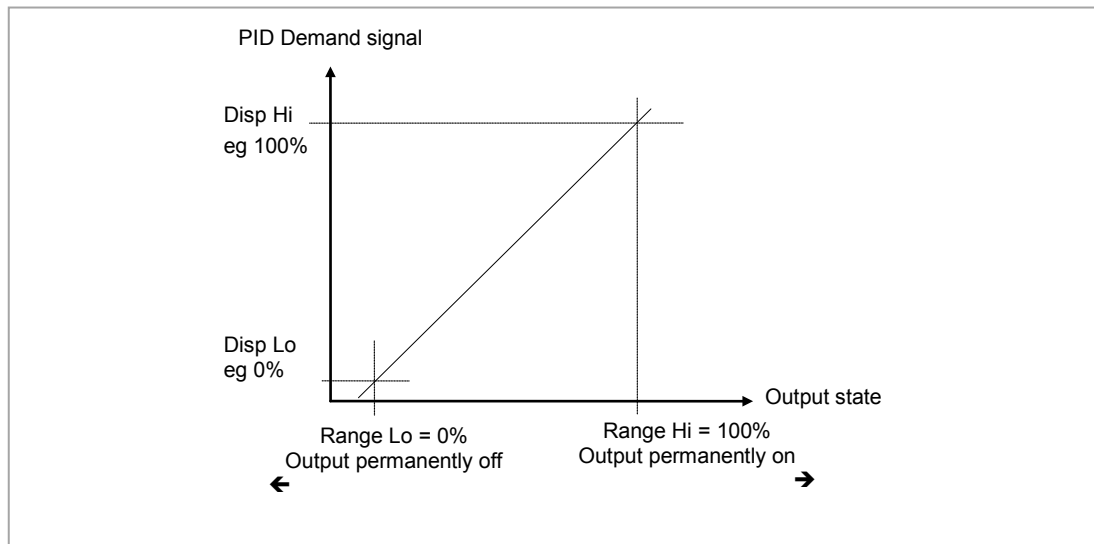

Figure 8-1: Scaling a Logic Output

### 8.2.6 Example: To Scale a Proportioning Logic Output

Select level 3 or configuration level as described in section 3.1.3. Then:-

Do This	The Display You Should See	Additional Notes
<ol style="list-style-type: none"> <li>From the 'LgcIO' page, press  to scroll to 'Disp Hi'</li> <li>Press  or  to set the PID demand limit. This will normally be 100%</li> <li>Repeat the above for 'Disp Lo'. This will normally be set to zero</li> </ol>		
<ol style="list-style-type: none"> <li>Press  to scroll to 'Range Hi'</li> <li>Press  or  to set the upper output limit.</li> <li>Repeat the above for 'Range Lo' to set the lower switching limit</li> </ol>		<p>In this example the output will switch on for 8% of the time when the PID demand signal is at 0%.</p> <p>Similarly, it will remain on for 90% of the time when the demand signal is at 100%</p>

## 9. Chapter 9 AA Relay Output

A changeover relay is standard on all 3500 series controllers and is connected to terminals AA (normally open), AB (common) and AC (normally closed).



Parameters in the 'RlyAA' list allow the relay functions to be set up.

### 9.1 To Select AA Relay List



Select Level 3 or Configuration level as described in Chapter 3.

Then press  as many times as necessary until the header 'RlyAA' is displayed

### 9.2 AA Relay Parameters

List Header - RlyAA		No Sub-headers			
Name  to select	Parameter Description	Value Press  or  to change values		Default	Access Level
IO Type	To configure the function for the relay	OnOff	On off output		Conf R/O L3
		Time Prop	Time proportioning output		

#### Parameters available if IO Type is configured as Time Proportioning

List Header - RlyAA		No Sub-headers			
Name  to select	Parameter Description	Value Press  or  to change values		Default	Access Level
Cycle Time  See also section 8.2.2.	Allows the output to be switched on and off within the set time period.	Off or 0.01 to 60.00 seconds	When Off is selected the Min OnTime algorithm will run. When set to any other value the CycleTime algorithm will run.	Off	L3
Min OnTime Only available when 'Cycle Time' = Off  See also section 8.2.2.	The minimum time (in seconds) that the relay is on or off.	Auto 0.01 to 150.00 seconds	If set to 0 - Auto the minimum on time will be 110mS. For a relay output this should be set greater than, say, 10 seconds to prevent the relay from switching too rapidly.	Auto	L3
Res'n	Display resolution. This sets the number of decimal places displayed by Disp Hi and Disp Lo parameters	XXXXX XXXX.X XXX.XX XX.XXX X.XXXX	No decimal points One decimal point Two decimal points Three decimal points Four decimal points	XXXXX	Conf
Disp Hi	The maximum displayable reading	0.000 to 100.000	These parameters allow high and low limits to be applied to the output against a set limit of the output demand signal from the PID loop. See also section 10.4.3 for further information	100.00	L3
Disp Lo	The minimum displayable reading	0.000 to 100.000		0.00	L3
Range Hi	The maximum (electrical) input/output level	0.00 to 100.00		L3	
Range Lo	The minimum (electrical) input/output level	0.00 to 100.00		L3	
SbyAct	Standby action. Determines the output action when the instrument is in Standby Mode. See Section 8.2.1.	Off On Cont	The output will drive to 'electrical low' value regardless of the 'Invert' parameter. The output will drive to 'electrical high' value regardless of the 'Invert' parameter. The output will assume a status according to how it is driven	Off	Conf R/O L3
Meas Val	Status of the digital output.	0 1	On (unless Invert = Yes) Off (unless Invert = Yes)		L3 R/O
PV	The current (analogue) value of the output	0 to 100			L3 R/O L3

**Parameters available if IO Type is configured as OnOff**

List Header - RlyAA		No Sub-headers			
Name ⌚ to select	Parameter Description	Value Press ▼ or ▲ to change values		Default	Access Level
Invert	To change the normal operating state of the relay.	No	Relay de-energised when the output demand is off Relay energised when the output demand is on (normal setting if the relay is used for control)		Conf R/O L3
		Yes	Relay energised when the output demand is off Relay de-energised when the output demand is on (normal setting if the relay is used for alarm)		
SbyAct	Standby action. Determines the output action when the instrument is in Standby Mode. See Section 8.2.1.	Off	The output will drive to 'electrical low' value regardless of the 'Invert' parameter.	Off	Conf R/O L3
		On	The output will drive to 'electrical high' value regardless of the 'Invert' parameter.		
		Cont	The output will assume a status according to how it is driven		
Meas Val	The current value of the output demand signal	0	On (unless Invert = Yes)		L3 R/O
		1	Off (unless Invert = Yes)		
PV	The current (digital) value of the output	0	On		L3 R/O L3
		1	Off		

PV can be wired to the output of a function block. For example if it is used for control it may be wired to the control loop output (Ch1 Output) as shown in the example in section 5.1.1.

If it is used for an alarm it may be wired to the 'Output' parameter in an alarm list.





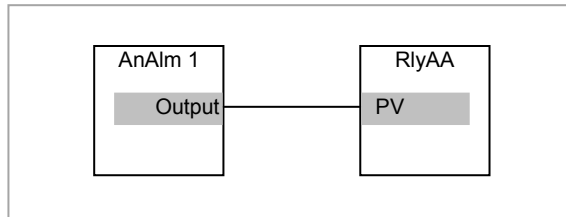



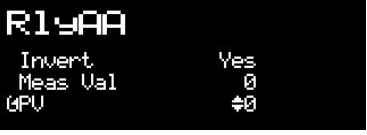

### 9.2.1 Example: To Wire the AA Relay to an Alarm

In this example the relay will be made to operate when analogue alarm 1 occurs.



Select configuration level as described in section 3.3.

Then:-

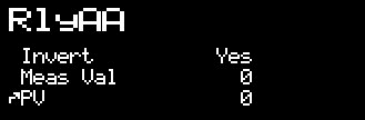
Do This	The Display You Should See	Additional Notes
1. From any display press  until the ' <b>RlyAA</b> ' page is reached 2. Press  to scroll to ' <b>PV</b> '		Set 'IO Typ' to 'OnOff' Set 'Invert' to 'Yes' This locates the parameter to be wired to
3. Press <b>A/MAN</b> to display ' <b>WireFrom</b> '		If the parameter is already wired the display shown below is shown
4. Press  (as instructed) as many times as necessary to select the ' <b>AnAlm</b> ' page 5. Press  or  to select ' <b>1</b> ' 6. Press  to scroll to ' <b>Output</b> '		This selects Analogue Alarm 1. The relay can also be wired to operate on one or more alarms. This 'copies' the parameter to be wired from
7. Press <b>A/MAN</b>		This 'pastes' the parameter to 'PV'
8. Press  as instructed to confirm		The arrow shown next to the parameter indicates that it has been wired



**Note:** To remove a wire see section 5.1.3

### 9.2.2 Relay Output Scaling

If the output is configured for time proportioning control, it can be scaled such that a lower and upper level of PID demand signal can limit the operation of the output value.

The procedure for this is the same as logic outputs described in section 8.2.5.

## 10. Chapter 10 Module Configuration

Plug in IO modules provide additional analogue and digital IO. These modules can be fitted in any of six slots. The terminal connections for these are given in Chapter 1 - Installation.

The type and position of any modules fitted in the controller is shown in the order code printed on the label on the side of the controller. This can be checked against the order code in Chapter 1.

The module part number is printed on the side of the plastic case of the module.

Spare modules can be ordered by contacting Eurotherm support/service where they can be supplied using a 'SUB' number. For reference this is shown in the final column of the table below.

All modules fitted are identified in the controller under the page heading 'ModIDs'.

Modules are available as single channel, two channel or three channel IO as listed below:-

Module	Instrument Order Code	Idents Displayed As	Number of Channels	Module Part No.	SUB part number
No module fitted	XX	No Module			
Change over relay	R4	COvrRelay	1	AH025408U002	SUB35/R4
2 pin relay	R2	Form A	1	AH025245U002	SUB35/R2
Dual relay	RR	Relay DualRelay	2	AH025246U002	SUB35/RR
Triple logic output	TP	TriLogic	3	AH025735U002	SUB35/TP
Isolated single logic output	LO	SinLogic	1	AH025735U003	SUB35/LO
Triac	T2	Triac	1	AH025253U002	SUB35/T2
Dual triac	TT	DualTriac	2	AH025409U002	SUB35/TT
DC control	D4	DC Output	1	AH025728U003	SUB35/D4
DC retransmission	D6	DCRetran	1	AH025728U002	SUB35/D6
Analogue input module	AM	DCInput	1	AH025686U004	SUB35/AM
Triple logic input	TL	TriLogIP	3	AH025317U002	SUB35/TL
Triple contact input	TK	TriConIP	3	AH025861U002	SUB35/TK
Potentiometer input	VU	PotIP	1	AH025864U002	SUB35/VU
24V transmitter supply	MS	TXPSU	1	AH025862U002	SUB35/MS
5V or 10Vdc Transducer power supply	G3	TransPSU	1	AH026306U002	SUB35/G3
Dual DC control output	DO	DualDCOut	2	AH027249 U002	SUB35/DO
High resolution DC output	HR	HFDCOut	2	AH027249 U003	SUB35/HR

Table 10: I/O Modules



**Note:** If an incorrect module is fitted (for example, from a 2000 series controller), 'Bad Ident' will be displayed.



**Note:** Parameters for the above modules, such as input/output limits, filter times and scaling of the IO, can be adjusted in the Module IO pages





### 10.1 To Fit a New Module

IO modules can be fitted in any of six slots in the 3504 and any of three slots in 3508 controllers.

Communications modules can be fitted in any of two slots

A list of available IO modules is given in Table 10-1

These modules are fitted simply by sliding them into the relevant position as shown below.

When a module has been changed, the controller will power up with the message **!Error M(X) Changed** where (X) is the module number. This must be acknowledged by pressing  and  together.

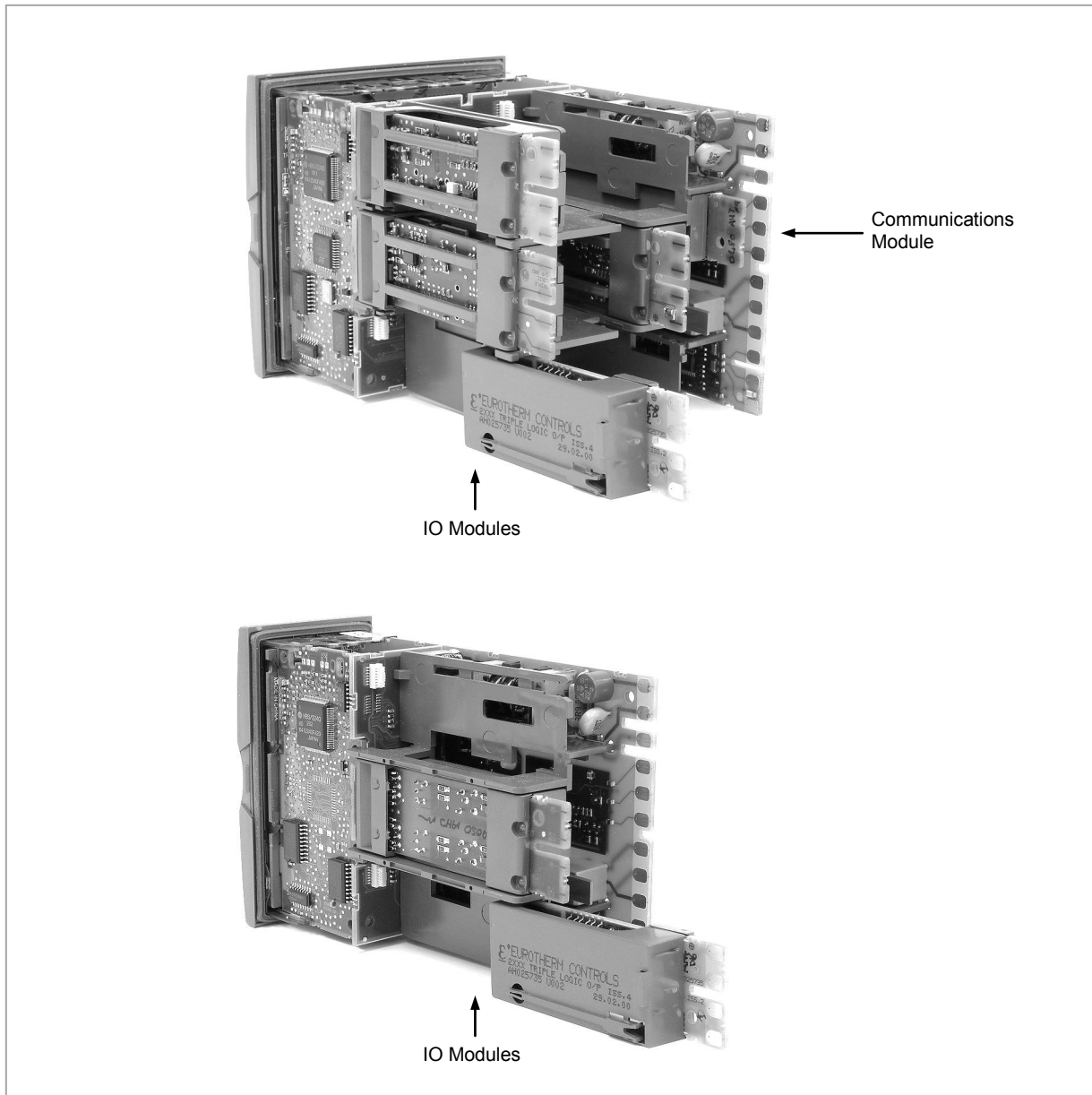



Figure 10-1: View of the Plug-in Modules

### 10.2 Module Identification



Press  until the list header 'ModIDs' is displayed. The type of IO module fitted in any of the six slots (three if 3508) is shown. The identification of the module fitted is shown in Table 10-1.

### 10.3 Module Types

The tables in the following pages list the parameters available for the different modules.

#### 10.3.1 Relay, Logic or Triac Outputs

These modules are used to provide an output to a two state output device such as a contactor, SSR, motorized valve driver, etc.

List Header - Mod		Sub-headers: xA (triac, changeover or 2-pin relay); xA and xC (dual relay, dual triac); xA, xB, xC (triple logic) x = the number of the slot in which the module is fitted			
Name  to select	Parameter Description	Value Press  or  to change values		Default	Access Level
Ident	Channel type	Relay	Any relay output		L3 R/O
		Logic Out	Logic output		
		Triac	Triac or dual triac output		
IO Type	To configure the function of the relay	OnOff	On off output		Conf R/O L3
		Time Prop	Time proportioning output		
		ValvRais	Motor valve position raise. <a href="#">See note below:</a>		



**Note:**



A triple logic output, a dual relay output or a dual triac output module may be used for a valve position output. If Valve Raise is configured on channel output A then Valve Lower is automatically allocated to channel output C. Channel output B (triple logic output) is only available as an on/off or time proportioning output.  
Valve raise/lower is not available on a single isolated logic output.

The following shows a summary of parameters which follow 'IO Type' for different configurations of the Output:-

OnOff	Time Prop	ValvRaise
Invert	Cycle Time	Min OnTime
SbyAct	Min OnTime	
Meas Val	Res'n	SbyAct
PV	Disp Hi	Meas Val
	Disp Lo	PV
	Range Hi	Inertia
	Range Lo	Backlash
	SbyAct	Cal State
	Meas Val	
	PV	

### Explanation of Relay, Logic, Triac Output Module Parameters

List Header - Mod		Sub-headers: xA (triac, changeover or 2-pin relay); xA and xC (dual relay, dual triac); xA, xB, xC (triple logic) x = the number of the slot in which the module is fitted			
Name Ⓢ to select	Parameter Description	Value Press Ⓡ or Ⓢ to change values		Default	Access Level
Invert	To change the normal operating state of the relay. This only applies if the output is configured as OnOff	No	Relay de-energised when output demand off and energised when output demand on Normal setting if the relay is used for control		Conf R/O L3
		Yes	Relay energised when output demand off and de-energised when output demand on Normal setting if the relay is used for an alarm		
SbyAct  See also section 8.2.1.	Standby action. Determines the output action when the instrument is in Standby Mode.	Off	The output will drive to 'electrical low' value regardless of the 'Invert' parameter.	Off	Conf R/O L3
		On	The output will drive to 'electrical high' value regardless of the 'Invert' parameter.		
		Cont	The output will assume a status according to how it is driven		
		For motor valve outputs the options are:-			
		Frz	Freeze – only shown if the output is configured for valve position control		
		Cont	Continue - only shown if the output is configured for valve position control		
Meas Value	Current state of the output	0	Off (if 'Invert' = 'No')		L3 R/O
		1	On (if 'Invert' = 'No')		
PV	Normally wired to the output of a function block such as PID output to control a plant actuator	0	Demand for output to be off (if 'Invert' = 'No')		Conf R/O L3 Alterable if not wired
		1	Demand for output to be on (if 'Invert' = 'No')		
The next seven parameters are only shown when 'IO Type' = 'Time Prop' outputs					
Cycle Time  See also section 8.2.2.	Allows the output to be switched on and off within the set time period. Applies only if the output type is Time Proportioning.	Off or 0.01 to 60.00 seconds	When Off is selected the Min OnTime algorithm will run. When set to any other value the CycleTime algorithm will run.	Off	L3
Min OnTime  See also section 8.2.2.	The minimum time (in seconds) that the relay is on or off. Applies only to an output type configured as Time Proportioning and is only available when 'Cycle Time' = Off	Auto 0.01 to 150.00 seconds	If set to 0 - Auto the minimum on time will be 110mS. For a relay output this should be set greater than, say, 10 seconds to prevent the relay from switching too rapidly.	Auto	L3
Res'n	Display resolution. This sets the number of decimal places displayed by Disp Hi and Disp Lo parameters	XXXXX XXXX.X XXX.XX XX.XXX X.XXXX	No decimal points One decimal point Two decimal points Three decimal points Four decimal points	XXXXX	Conf
Disp Hi	The maximum displayable reading	0.000 to 100.000	These parameters allow high and low limits to be applied to the output against a set limit of the output demand signal from the PID loop. See also section 10.4.3 for further information	100.00	L3
Disp Lo	The minimum displayable reading	0.000 to 100.000		0.00	L3
Range Hi	The maximum (electrical) input/output level	0.00 to 100.00		L3	

List Header - Mod		Sub-headers: xA (triac, changeover or 2-pin relay); xA and xC (dual relay, dual triac); xA, xB, xC (triple logic) x = the number of the slot in which the module is fitted			
Name  to select	Parameter Description	Value Press  or  to change values		Default	Access Level
Range Lo	The minimum (electrical) input/output level	0.00 to 100.00			L3
The following parameters are additional if 'IO Type' = 'Valve Rais'					
Inertia	Set this parameter to match the inertia (if any) of the motor	0.0 to 9999.9 secs		0.0	L3
Backlash	This parameter compensates for any backlash which may be present in the linkages	0.0 to 9999.9 secs		0.0	L3
Cal State	Calibration state	Idle Raise lower	See also section 26.4 for further details.		L3
Status	Module status	OK	Normal operation <a href="#">See note below:</a>		R/O



**Note:** Status appeared in some earlier controllers and displays a message giving the current operating condition of the module.

These may be:-

- |                              |                             |
|------------------------------|-----------------------------|
| 0: Normal operation          | 8: Channel 1 not calibrated |
| 1: Initial startup mode      | 9: Channel 2 not calibrated |
| 2: Channel 1 sensor break    | 20: Latched up              |
| 3: Channel 2 sensor break    | 21: Channel 1 open circuit  |
| 4: Channel 1 out of range    | 22: Channel 2 open circuit  |
| 5: Channel 2 out of range    | 23: Channel 1 short circuit |
| 6: Channel 1 saturated input | 24: Channel 2 short circuit |
| 7: Channel 2 saturated input | 25: No Module               |

The number is the enumeration of the status.

### 10.3.2 Single Isolated Logic Output

This provides isolation from other IO and should be used, for example, in applications where the sensor and the output device may be at supply potential. It is only available as a time proportioning or on/off output.

List Header - Mod		Sub-headers: xA			
Name ⊙ to select	Parameter Description	Value Press ▼ or ▲ to change values		Default	Access Level
Ident	Channel type	Logic Out	Logic output		L3 R/O
IO Type	To configure the function of the relay	OnOff	On off output		Conf R/O L3
		Time Prop	Time proportioning output		
Invert	Sets the sense of the logic output. This only applies if the output is configured as OnOff	No	Non inverted. Output off (logic 0) when PID demand off. For control this is when PV>SP. Output on (logic 1) when PID demand off. For control this is when PV<SP. This is the normal setting for control.		Conf R/O L3
		Yes	Inverted. Output off (logic 0). For an alarm this is when the alarm is active. Output on (logic 1). For an alarm this is when the alarm is in-active. This is the normal setting for alarms.		
SbyAct  See also section 8.2.1.	Standby action. Determines the output action when the instrument is in Standby Mode.	Off	The output will drive to 'electrical low' value regardless of the 'Invert' parameter.	Off	Conf R/O L3
		On	The output will drive to 'electrical high' value regardless of the 'Invert' parameter.		
		Cont	The output will assume a status according to how it is driven		
Meas Value	Current state of the output	0	Off (if 'Invert' = 'No')		L3 R/O
		1	On (if 'Invert' = 'No')		
PV	Normally wired to the output of a function block such as PID output to control a plant actuator	0	Output off (if 'Invert' = 'No')		Conf R/O L3
		1	Output on (if 'Invert' = 'No') Alterable if not wired		
Status	Module status <a href="#">See note - section 10.3.1</a>	OK	Normal operation		R/O
The next six parameters are only shown when 'IO Type' = 'Time Prop' outputs					
CycleTime See also section 8.2.2.	To switch the output on and off within the set time period. Applies only to Time Proportioning outputs.	Off or 0.01 to 60.00 seconds	When Off is selected the Min OnTime algorithm will run. When set to any value the CycleTime algorithm will run.	Off	L3
Min OnTime See also section 8.2.2.	The minimum time (in seconds) that the logic output is on or off. Applies only to Time Proportioning outputs and is only available when 'Cycle Time' = Off	Auto 0.01 to 150.00 seconds	If set to Auto the minimum on time will be 110mS. If the logic is used to control an external relay, Min OnTime should be set to a minimum of (say) 10 seconds to prevent the relay from switching too rapidly.	Auto	L3
Res'n	Display resolution. This sets the number of decimal places displayed by Disp Hi and Disp Lo parameters	XXXXX XXXX.X XXX.XX XX.XXX X.XXXX	No decimal points One decimal point Two decimal points Three decimal points Four decimal points	XXXXX	Conf
Disp Hi/Lo	Maximum/minimum output demand signal	0.00 to 100.00	These parameters allow high and low limits to be applied to the output against a set limit of the output demand signal from the PID loop. See also section 10.4.3.	100.00	L3
Range Hi/Lo	Electrical output high/low	0.00 to 100.00		L3	
Meas Value	The current status of the digital output.	0	On (unless Invert = Yes)		L3 R/O L3
		1	Off (unless Invert = Yes)		

### 10.3.3 DC Control, Dual DC Control, or DC Retransmission Output

The DC output module is used as a control output to interface with an analogue actuator such as valve driver or thyristor unit. The dual DC control output uses two channels xA and xC.

The DC retransmission module is used to provide an analogue output signal proportional to the value which is being measured. It may be used for chart recording or retransmit a signal to another controller. This function is often performed through digital communications where greater accuracy is required.

List Header - Mod		Sub-headers: xA (DC Control and DC Retransmission) xA and xC (Dual DC Control) x = the number of the slot in which the module is fitted			
Name ⌚ to select	Parameter Description	Value Press ⏴ or ⏵ to change values		Default	Access Level
Ident	Channel type	DC Out DCRetran	DC Output (single or dual output) DC retransmission		L3 R/O
IO Type	To configure the output drive signal	Volts	Volts dc Set the IO Type to 'Volts' to use the Dual DC Output as a transducer power supply.	As order code	Conf L3 R/O
		mA	milli-amps dc		
Res'n	Display resolution	XXXXX to X.XXXX	No decimal points to four decimal points		Conf
Disp Hi	Display high reading	-99999 to 99999 decimal points depend on resolution HHHHH = out of high range LLLLL = out of low range		100	L3
Disp Lo	Display low reading			0	L3
Range Hi	Electrical high input level	0 to 10		10	L3
Range Lo	Electrical low input level			0	L3
Meas Value	The current output value				R/O
PV					L3
Cal State	Calibration state	Idle Lo Hi Confirm Go Abort Busy Passed Failed Accept	Non calibrating state Select calibration of the low position Select calibration of the high position Confirm the position to calibrate Start calibration Abort calibration Controller automatically calibrating Calibration OK Calibration bad To store the new values	Idle	Conf
The above 8 parameters are not available on Dual DC Output module when IO Type is set to Volts.					
Status <a href="#">See note section 10.3.1</a>	Working condition of the module	OK	Normal operation		R/O

### 10.3.4 High Resolution DC Output

This module (order code HR) can be fitted in slots 1, 2 or 4.

It contains two channels. The first (channel A) provides a high resolution, 15 bit, 4-20mA or 0-10Vdc retransmission signal. The second (channel C) provides 24Vdc (20 to 30Vdc) transmitter power supply. The module provides full 240Vac isolation.

#### Channel A

List Header - Mod		Sub-headers: 1A, 2A or 4A (DC Control and DC Retransmission)			
Name ⌚ to select	Parameter Description	Value Press ⏴ or ⏵ to change values		Default	Access Level
Ident	Channel type	HiRes Out			L3 R/O
IO Type	To configure the output drive signal	Volts mA	Volts dc <sup>(2)</sup> milli-amps dc	As order code	Conf R/O in L3
Status	Working condition of the module	See note - section 10.3.1			L3 R/O
The following additional parameters are shown for IO Type = mA					
Res'n	Display resolution	XXXXX to X.XXXX	No decimal points to four decimal points		Conf
Disp Hi	The maximum displayable reading	-99999 to 99999 decimal points depend on resolution		0	L3
Disp Lo	The minimum displayable reading	-99999 to 99999 decimal points depend on resolution		0	L3
Range Hi	The maximum (electrical) input level	Between 4.00 and Range Lo (normally set to 20.00mA)		4.00	L3
Range Lo	The minimum (electrical) input level	Between 4.00 and Range Hi (normally set to 4.00mA)		4.00	L3
Meas Value	Displays the current value of the output demand signal in electrical units				R/O
PV	Requested output signal level	-99999 to 99999. This parameter is normally soft wired to retransmit a selected parameter such as PV.			L3
Cal State	Allows the module to be calibrated	Idle Lo Confirm Go Trim Hi Accept Abort	Unit not being calibrated Low calibration point for DC output Confirm the action Start calibration  High calibration point for DC output Store user calibration Abort user calibration		Conf
Cal Trim	Shown when Cal State is in Trim mode. It allows a trim to be applied to the calibration points				Conf
CalStateHi	Shown when the output is being calibrated				Conf
CalStateLo					Conf

#### Channel C



List Header - Mod		Sub-headers: 1C, 2C or 4C (24V transmitter supply)			
Ident	Channel type	24V PSU	24V transmitter supply		L3 R/O
IO Type	Output type	Volts	Volts	Volts	Conf L3 R/O

### 10.3.5 Analogue Input

The analogue input module provides additional analogue inputs for multi-loop controllers or other multi input measurements.

List Header - Mod		Sub-headers: xA x = the number of the slot in which the module is fitted			
Name Ⓞ to select	Parameter Description	Value Press Ⓞ or ▲ to change values		Default	Access Level
Ident	Channel type	Analog IP			L3 R/O
IO Type	PV input type Selects input linearisation and range	ThermoCpl	Thermocouple		Conf L3 R/O
		RTD	Platinum resistance thermometer		
		Log10	Logarithmic		
		HiZV	High impedance voltage input (typically used for zirconia probe)		
		V	Voltage		
		mA	milli amps		
		80mV	80 milli volts		
		40mV	40 milli volts		
	Pyrometer	Pyrometer			
Lin Type	Input linearisation	See section 10.3.6			L3 R/O
Units	Controller units	See section 10.3.7			Conf
Res'n	Resolution	XXXXX to X.XXXX	No decimal points to four decimal points		Conf
CJC Type	To select the cold junction compensation method	Internal 0°C 45°C 50°C External Off	See description in section 7.2.2. for further details	Internal	Conf
SBrk Type	Sensor break type	Low	Sensor break will be detected when its impedance is greater than a 'low' value		Conf
		High	Sensor break will be detected when its impedance is greater than a 'high' value		
		Off	No sensor break		
SBrk Alarm	Sets the alarm action when a sensor break condition is detected	ManLatch	Manual latching	See also Chapter 12 'Alarms'	L3
		NonLatch	No latching		
		Off	No sensor break alarm		
SBrk Out	Status of the sensor break alarm	Off or On			L3
Disp Hi	Display reading high	See section 10.4.1			L3
Disp Lo	Display reading low				L3
Range Hi	Input high value				L3
Range Lo	Input low value				L3
Fallback	Configures the default value in case of an erroneous condition. The error may be due an out of range value, a sensor break, lack of calibration or a saturated input.  The Status parameter would indicate the error condition and could be used to diagnose the problem.  Fallback has several modes and may be associated with the Fallback PV parameter.	Downscale	Same as PV input		Conf
		Upscale	See section 0. for further explanation		
		Fall Good			
		Fall Bad			
		Clip Good			
		Clip Bad			



List Header - Mod		Sub-headers: xA x = the number of the slot in which the module is fitted		
Name  to select	Parameter Description	Value Press  or  to change values	Default	Access Level
Fallback PV	To set the value of PV during a sensor break	Instrument range		Conf
Filter Time	Input filter time. An input filter provides damping of the input signal. This may be necessary to prevent the effects of excessive noise on the PV input.	Off to 500:00 (m:ss.s) (hh:mm:ss) or (hh:mm)	0:00.4	L3
Emiss	Emissivity. This parameter only appears if the input is configured for Pyrometer. It is used to compensate for the different reflectivity produced by different type of surface	Off 0.1 to 1.0	1.0	L3
Meas Value	The current electrical value of the PV input			L3 R/O
PV	The current value of the PV input in engineering units	Instrument range		L3 R/O
Offset	Single offset value applied to the input see section 0.	Instrument range		L3
Lo Point	Allows a two point offset to be applied to the controller to compensate for sensor or connection errors between sensor and the input to the controller. See section 7.2.8 for further details	Instrument range		L3
Lo Offset				
Hi Point				
Hi Offset				
CJC Temp	Reads the temperature of the rear terminals at the thermocouple connection			Conf R/O
SBrk Value	Used for diagnostics only, and displays the sensor break trip value.			L3 R/O
Lead Res	The measured lead resistance on the RTD			L3 R/O
Cal State	Calibration state	Idle	Non calibrating state	Conf
		Lo	Select low point calibration	
		Hi	Select high point calibration	
		Confirm	Confirm the position to calibrate	
		Go	Start calibration	
		Abort	Abort calibration	
		Busy	Automatically calibrating	
		Passed	Calibration OK	
		Failed	Calibration bad	
Accept	To store the new values			
Status <a href="#">See note section 10.3.1</a>	The current status for the channel.	0	Normal operation	L3 R/O

**10.3.6 Input Types and Ranges**

Input Type		Min Range	Max Range	Units	Min Range	Max Range	Units
J	Thermocouple type J	-210	1200	°C	-238	2192	°F
K	Thermocouple type K	-200	1372	°C	-238	2498	°F
L	Thermocouple type L	-200	900	°C	-238	1652	°F
R	Thermocouple type R	-50	1700	°C	-58	3124	°F
B	Thermocouple type B	0	1820	°C	32	3308	°F
N	Thermocouple type N	-200	1300	°C	-238	2372	°F
T	Thermocouple type T	-200	400	°C	-238	752	°F
S	Thermocouple type S	-50	1768	°C	-58	3214	°F
PL2	Thermocouple Platinel II	0	1369	°C	32	2466	°F
C	Thermocouple type C						
PT100	Pt100 resistance thermometer	-200	850	°C	-328	1562	°F
Linear	mV or mA linear input	-10.00	80.00				
SqRoot	Square root						
Custom	Customised linearisation tables						

**10.3.7 Display Units**

None

Abs Temp °C/°F/°K,

V, mV, A, mA,

PH, mmHg, psi, Bar, mBar, %RH, %, mmWG, inWG, inWW, Ohms, PSIG, %O2, PPM, %CO2, %CP, %/sec,

RelTemp °C/°F/°K(rel),

Custom 1, Custom 2, Custom 3

sec, min, hrs,

### 10.3.8 Triple Logic Input and Triple Contact Input

This module may be used to provide additional logic inputs.

List Header - Mod		Sub-headers: xA, xB, xC x = the number of the slot in which the module is fitted			
Name ⌚ to select	Parameter Description	Value Press ⏴ or ⏵ to change values		Default	Access Level
Ident	Channel type	Logic In	Logic input or contact input		L3 R/O
IO Type	Function of the module	Input			L3 R/O
PV	State of the measured input	0 1	Demand for output to be off Demand for output to be on		Conf R/O L3
Status <a href="#">See note section 10.3.1</a>	Module status	OK	Normal operation		R/O

### 10.3.9 Potentiometer Input

This module may be connected to a feedback potentiometer fitted to a motorized valve driver, or to provide a measured value from any other potentiometer input between 100Ω and 15KΩ. The excitation voltage is 0.5Vdc.

List Header - Mod		Sub-headers: xA x = the number of the slot in which the module is fitted			
Name ⌚ to select	Parameter Description	Value Press ⏴ or ⏵ to change values		Default	Access Level
Ident	Channel type	Pot Input	Potentiometer input		L3 R/O
Units	Engineering units.	None			Conf
Res'n	Display resolution	XXXXX to X.XXXX	No decimal points to four decimal points		Conf
SBrk type	Allows one of three strategies to be configured if potentiometer break is indicated. Same as analogue input	Low	Sensor break will be detected when its impedance is greater than a 'low' value		Conf
		High	Sensor break will be detected when its impedance is greater than a 'high' value		Conf
		Off	No sensor break		Conf
SBrk Alarm	To configure the alarm action should the potentiometer become disconnected	Off NonLatch ManLatch	No sensor break alarm Non latching sensor break alarm Manual latching sensor break alarm		L3
Fallback	Condition to be adopted if the 'Status' parameter ≠ OK	Clip Bad Clip Good Fall Bad Fall Good Upscale DownScale	See section 0. for further explanation		Conf
Fallback PV		-99999 to 99999			Conf
Filter Time	To adjust the input filter time constant to reduce the effect of noise on the input signal	Off or 0:00.1 to 500:00		0:00:04	L3
Meas Value	The current value in engineering units				L3 R/O
PV	Requested output/current input signal level (after linearisation where applicable).				L3 R/O
SBrk Value	Used for diagnostics only, and displays the sensor break trip value.				L3 R/O
Cal State	This parameter allows the controller to be calibrated	Idle	Non calibrating state	Idle	Conf
		Lo	Select calibration of the low position		L3 R/O

List Header - Mod		Sub-headers: xA x = the number of the slot in which the module is fitted			
Name ⌂ to select	Parameter Description	Value Press ▼ or ▲ to change values		Default	Access Level
	against the maximum and minimum positions of the potentiometer. Adjust the pot to minimum position, select 'Lo' followed by 'Confirm'. The controller will automatically calibrate to this position. Repeat for the maximum position and selecting 'Hi'. If the potentiometer is part of the valve positioning motor it may be difficult to adjust the pot position. In this case refer back to section 8.2.4.	Hi	Select calibration of the high position		
		Confirm	Confirm the position to calibrate		
		Go	Start calibration		
		Abort	Calibration stopped		
		Busy	Controller automatically calibrating		
		Passed	Calibration OK		
		Failed	Calibration bad		
		Accept	To start using the new values		
		Save User	To store the new values to EE memory (For User calibration)		
		Save Fact	To store the new values to EE memory (For Factory calibration: password protected)		
Load Fact	Load factory calibration (Save User required for permanent use of Factory calibration).				
Status <a href="#">See note section 10.3.1</a>	Working condition of the module	OK Sbreak	Potentiometer input broken		R/O

### 10.3.10 Transmitter Power Supply

This module may be used to provide 24Vdc to power an external transmitter.

List Header - Mod		Sub-headers: xA, xB, xC x = the number of the slot in which the module is fitted			
Name ⌂ to select	Parameter Description	Value Press ▼ or ▲ to change values		Default	Access Level
Ident	Channel type	TxPSU	Transducer power supply		L3 R/O
Status <a href="#">See note section 10.3.1</a>	Module status	OK	Normal operation		R/O

### 10.3.11 Transducer Power Supply

The transducer power supply may be used to power an external transducer which requires an excitation voltage of 5 or 10V. It contains an internal shunt resistor for use when calibrating the transducer. The value of this resistor is  $30.1\text{K}\Omega \pm 0.25\%$  when calibrating a  $350\Omega$  bridge.

List Header - PV Input		Sub-headers: xA x = the number of the slot in which the module is fitted			
Name ⌚ to select	Parameter Description	Value Press ⏴ or ⏵ to change values		Default	Access Level
Ident	Channel type	TransPSU	Transducer power supply		R/O
Meas Value	The current output value				R/O
PV	Requested output/current input signal level (after linearisation where applicable). Normally wired				
Status <a href="#">See note section 10.3.1</a>	The current status for the channel.	OK	Normal operation		R/O
Shunt		External Internal	Select external calibration resistor Select internal calibration resistor 30.1K $\Omega$	External	Conf
Voltage	To select the output voltage	10 Volts 5 Volts	10 Volts 5 Volts		Conf

## 10.4 Module Scaling

The controller is calibrated for life against known reference standards during manufacture, but user scaling allows you to offset the 'permanent' factory calibration to either:-

1. Scale the controller to your reference standards
2. Match the calibration of the controller to an individual transducer or sensor
3. To compensate for known offsets in process measurements

### 10.4.1 Analogue Input Scaling and Offset

Scaling of the analogue input uses the same procedure as described for the PV Input (Chapter 7) and applies to linear process inputs only, eg linearised transducers, where it is necessary to match the displayed reading to the electrical input levels from the transducer. PV input scaling is not provided for direct thermocouple or RTD inputs.

Figure 10-2 shows an example of input scaling, where an electrical input of 4-20mA requires the display to read 2.5 to 200.0 units.

Offset has the effect of moving the whole curve, shown in Figure 10-2, up or down about a central point. The 'Offset' parameter is found in the 'Mod' page under the number of the slot position in which the Analogue Input module is fitted.

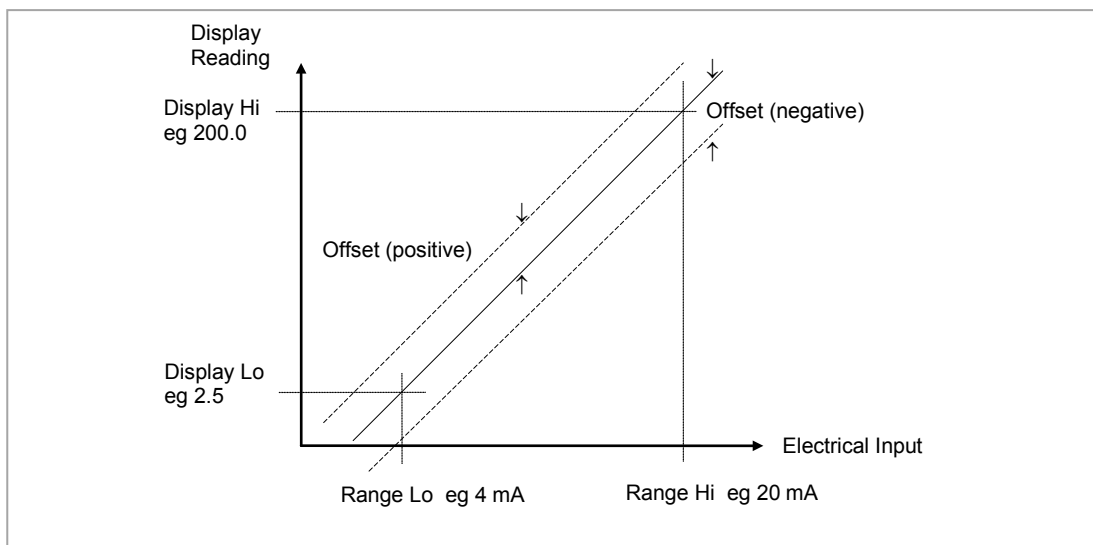

Figure 10-2: Input Scaling (Standard IO)

To scale a mA analogue input as shown in the above example:-

(This also applies to V or mV input types).

1. Select Conf as described in Chapter 3. Then press to select the page header in which the analogue input module is fitted
2. Press to scroll to 'Disp Hi'. Then press or to '200.0'
3. Press to scroll to 'Disp Lo'. Then press or to '2.5'
4. Press to scroll to 'Range Hi'. Then press or to '20.0'
5. Press to scroll to 'Range Lo'. Then Press or to '4.00'
6. Press to scroll to 'Offset'. Then Press or to adjust the offset in a positive or negative direction as required

### 10.4.2 Two Point Offset

A two point offset applies to Analogue Input Modules in the same way as the PV Input. The procedure is described in section 7.2.8.

### 10.4.3 Relay, Logic or Triac Output Scaling

If the output is configured for time proportioning control, it can be scaled such that a lower and upper level of PID demand signal can limit the operation of the output value.

By default, the output will be fully off for 0% power demand, fully on for 100% power demand and equal on/off times at 50% power demand. You can change these limits to suit the process. It is important to note, however, that these limits are set to safe values for the process. For example, for a heating process it may be required to maintain a minimum level of temperature. This can be achieved by applying an offset at 0% power demand which will maintain the output on for a period of time. Care must be taken to ensure that this minimum on period does not cause the process to overheat.

If Range Hi is set to a value <100% the time proportioning output will switch at a rate depending on the value - it will not switch fully on.

Similarly, if Range Lo is set to a value >0% it will not switch fully off.

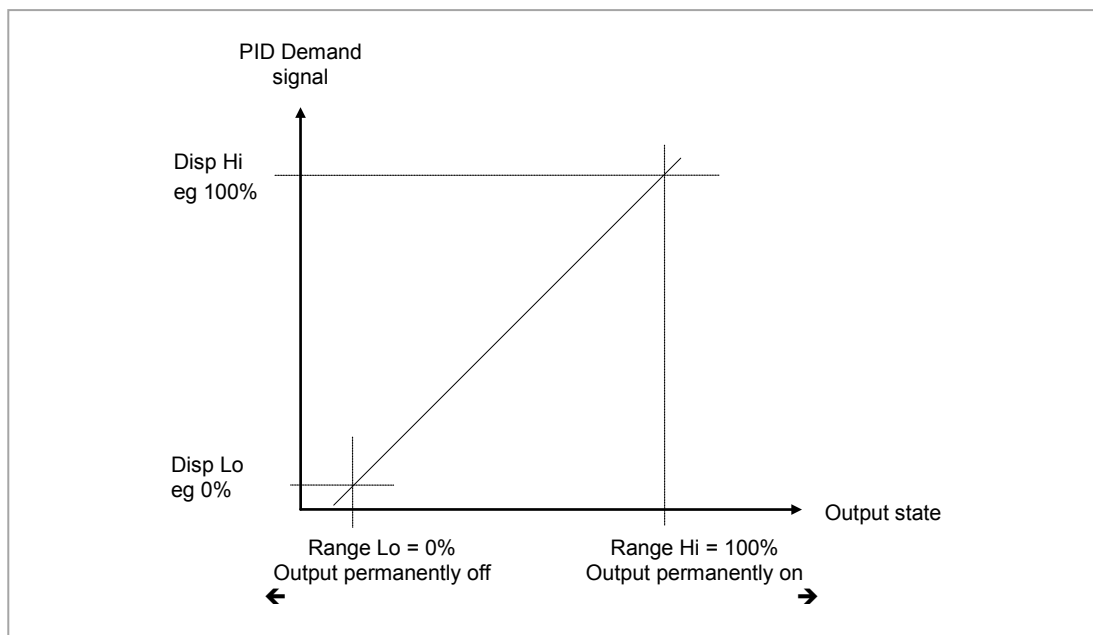

Figure 10-3: Time Proportioning Output





The procedure for adjusting these parameters is the same as that given in the previous section.

### 10.4.4 Analogue Output Scaling

Analogue control or retransmission outputs are scaled in exactly the same way as above except that Range Lo and Hi corresponds to the electrical output (0 to 10V, 4 to 20mA, etc). For an analogue retransmission output Disp Lo and Hi correspond to the reading on the display and for an analogue control output Disp Lo and Hi corresponds to the PID demand output signal from the control block.

### 10.4.5 Potentiometer Input Scaling

When using the controller in bounded valve position mode, it is necessary to calibrate the feedback potentiometer to correctly read the position of the valve. The minimum position of the potentiometer corresponds to a measured value reading of 0 and the maximum position corresponds to 100. This may be carried out in Access level 3:-

1. Adjust the potentiometer for the minimum required position. This may not necessarily be on the end stop.
2. Press  to scroll to '**Cal State**'. Then press  or  to '**Lo**' and "**Confirm**". The display will show '**Go**' followed by '**Busy**' while the controller automatically calibrates to the minimum position. When complete '**Passed**' should be displayed. If '**Failed**' is displayed this may indicate that the potentiometer is outside the range of the input.
3. Adjust the potentiometer for the maximum required position. This may not necessarily be on the end stop.
4. Repeat 2 above for the 'Hi' position
5. The controller will now use these values until it is powered down. If it required to store these values, which is the usual case, press  or  to '**Accept**'. The controller will store these values for future use.



## 11. Chapter 11 IO Expander

The IO Expander is an external unit which can be used in conjunction with the 3500 series controllers to allow the number of digital IO points to be increased. There are two versions:-

10 Inputs and 10 Outputs

20 Inputs and 20 Outputs

Each input is fully isolated and voltage or current driven. Each output is also fully isolated consisting of four changeover contacts and six normally open contacts in the 10 IO version and four changeover and sixteen normally open contacts in the 20 IO version.

Data transfer is performed serially via an IO Expander module which is fitted in the J serial communications slot. This module is identified as 'IOExp' in the 'Comms' 'J' parameter list (see Chapter 14). It should be noted that, when this module is fitted in the J comms slot the remaining parameters in the 'Comms' 'J' list are not used.

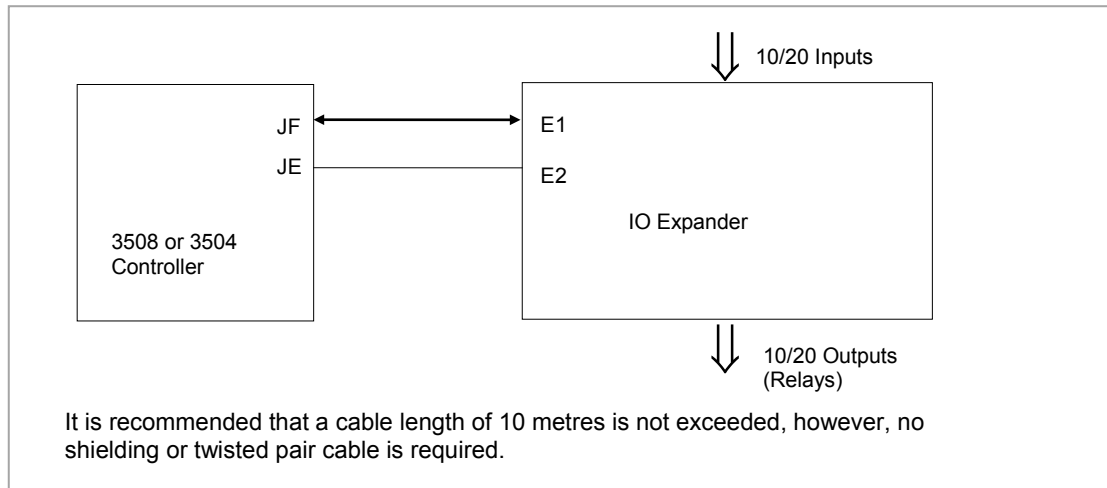

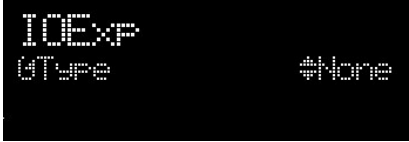



**Figure 11-1: IO Expander Data Transfer**

Wiring connections and further details of the IO Expander are given in the IO Expander Handbook, Part No. HA026893.

When this unit is connected to the controller it is necessary to set up parameters to determine its operation. These parameters can be set up in Level 3 or configuration level.

The IO Expander is enabled in Inst/Options Page, see Chapter 6.

### 11.1 To Configure the IO Expander









Do This	The Display You Should See	Additional Notes
1. From any display press  until the 'IOExp' page is reached		
2. Press  to scroll to 'Type' 3. Press  or  to select '10In10Out'		This configured an Io Expander for 10 inputs and 10 outputs. A further choice is 20In20Out

Remaining parameters in the Analogue Operators list are accessed and adjusted in the same way.



The list of parameters available is shown in the following table

#### 11.1.1 IO Expander Parameters

List Header: IOExp		Sub-headers: None		
Parameter Name	Parameter Description	Value	Default	Access Level
Expander Type	Expander type	None 10In 10Out 20In 20Out	None 10 inputs 10 outputs 20 inputs 20 outputs	Conf
Status	IO Expander status	Good COMM FAIL	OK No communications	L3 R/O
In 1-10	Status of the first 10 digital inputs □□□□□□□□□□ to ■■■■■■■■■■	□ = Off ■ = On		L3 R/O
In 11-20	Status of the second 10 digital inputs □□□□□□□□□□ to ■■■■■■■■■■	□ = Off ■ = On		L3 R/O
Out21-30	Status of the first 10 digital outputs. Press  to select outputs in turn. The flashing underlined output can be changed using  buttons.  □□□□□□□□□□ to  ■■■■■■■■■■	□ = Off ■ = On		L3
Out31-40	Status of the second 10 digital outputs. Press  to select outputs in turn. The flashing underlined output can be changed using  buttons.  □□□□□□□□□□ to  ■■■■■■■■■■	□ = Off ■ = On		L3
Inv21-30	To change the sense of the first 10 outputs.	□ = direct ■ = Inverted		L3
Inv31-40	To change the sense of the second 10 outputs.	□ = direct ■ = Inverted		L3
In1 to In 20	State of each configured input	0 or 1	These are normally wired to a digital source. If not wired they can be changed here	L3
Out21 to Out 40	State of each configured output	0 or 1	Off or On	L3

## 12. Chapter 12 Alarms

**Alarms** are used to alert an operator when a pre-set level has been exceeded. They are indicated by a message in the message centre and the red ALM beacon as described in section 2.7. They may also switch an output— usually a relay (see section 12.3.2) – to allow external devices to be operated when an alarm occurs.

Alarms can be divided into two main types. These are Analogue and Digital Alarms:-

- Analogue alarms** operate by monitoring an analogue variable such as the process variable and comparing it with a set threshold.
- Digital alarms** operate when the state of a boolean variable changes, for example, sensor break.
- Number of Alarms** up to eight analogue and eight digital alarms may be configured. Any alarm can be enabled in the 'Inst' 'Enb' list as described in Chapter 6.

### 12.1 Further Alarm Definitions

- Soft Alarms** are indication only and do not operate an output.
- Events** are indication only but can operate an output. They can also be configured, using the editing tool (iTools), to provide text messages on the display. For the purpose of the configuration of this controller, alarms and events can be considered the same.
- Hysteresis** is the difference between the point at which the alarm switches 'ON' and the point at which it switches 'OFF'. It is used to provide a definite indication of the alarm condition and to prevent alarm relay chatter.
- Latching Alarm** used to hold the alarm condition once an alarm has been detected. It may be configured as:-
- |        |              |  |
|--------|--------------|--|
| None   | Non latching | A non latching alarm will reset itself when the alarm condition is removed   |
| Auto   | Automatic    | An auto latching alarm requires acknowledgement before it is reset. The acknowledgement can occur BEFORE the condition causing the alarm is removed.   |
| Manual | Manual       | The alarm continues to be active until both the alarm condition is removed AND the alarm is acknowledged. The acknowledgement can only occur AFTER the condition causing the alarm is removed. |
| Event  | Event        | ALM beacon does not light but an output associated with this parameter will activate and a scrolling message will appear if this has been configured.  |
- Blocking Alarms** The alarm may be masked during start up. Blocking prevents the alarm from being activated until the process has first achieved a safe state. It is used, for example, to ignore start up conditions which are not representative of running conditions. A blocking alarm is re-initiated after a setpoint change.
- Delay** Applies to analogue alarms. A short time can be set for each alarm which prevents the output from going into the alarm state. The alarm is still detected as soon as it occurs, but if it cancels before the end of the delay period then no output is triggered. The timer for the delay is then reset. It is also reset if an alarm is changed from being inhibited to uninhibited.

## 12.2 Analogue Alarms

Analogue alarms operate on variables such as PV, output levels, etc. They can be soft wired to these variables to suit the process.

### 12.2.1 Analogue Alarm Types

**Absolute High** - an alarm occurs when the PV exceeds a set high threshold.

**Absolute Low** - an alarm occurs when the PV exceeds a set low threshold.

**Deviation High** - an alarm occurs when the PV is higher than the setpoint by a set threshold

**Deviation Low** - an alarm occurs when the PV is lower than the setpoint by a set threshold

**Deviation Band** - an alarm occurs when the PV is higher or lower than the setpoint by a set threshold

These are shown graphically below for changes in PV plotted against time. (Hysteresis set to zero)

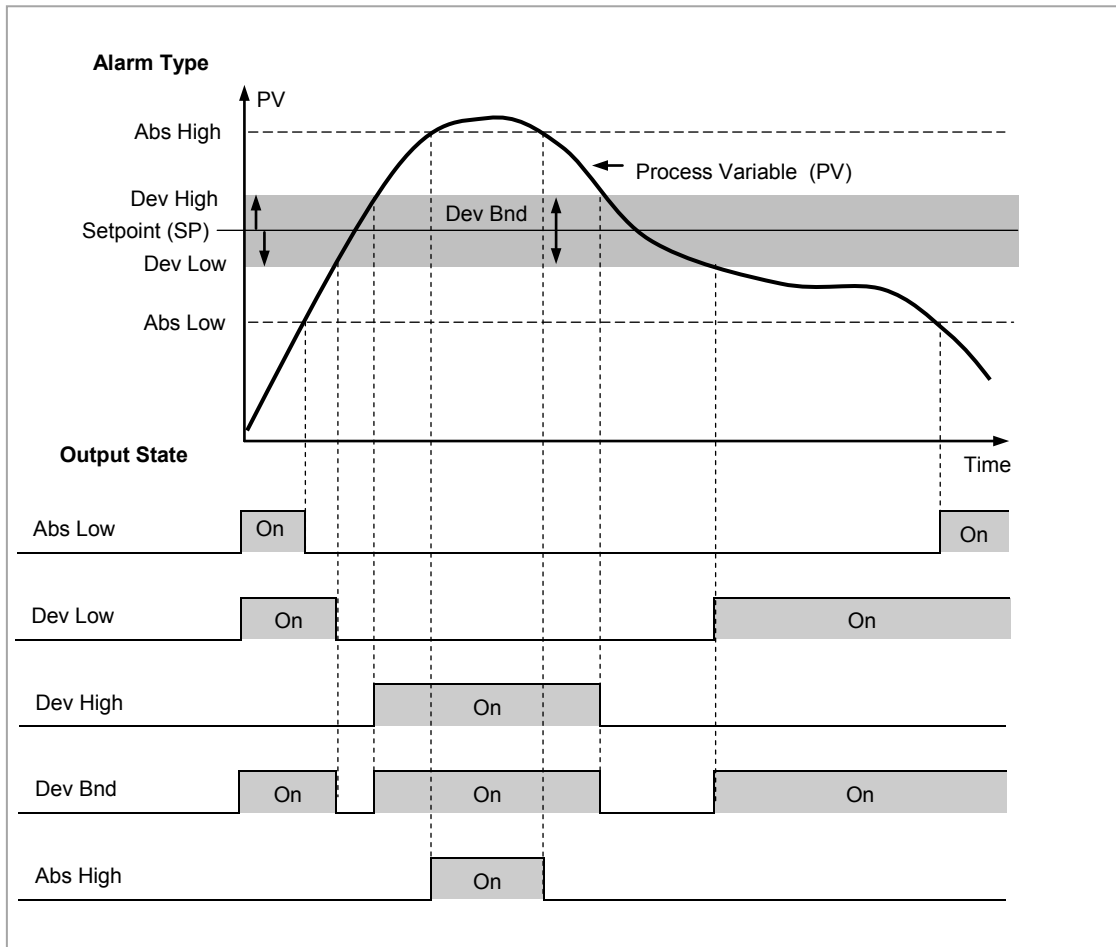

Figure 12-1: Alarm Output Status for Different Alarm Types

## 12.3 Digital Alarms

Digital alarms operate on Boolean variables. They can be soft wired to any suitable Boolean parameter such as digital inputs or outputs. When the state of the variable changes an alarm message is shown on the display. This message can be customised as described in Chapter 27.

### 12.3.1 Digital Alarm Types

<b>Pos Edge</b>	The alarm will trigger when the input changes from a low to high condition
<b>Neg Edge</b>	The alarm will trigger when the input changes from a high to low condition
<b>Edge</b>	The alarm will trigger on any change of state of the input signal
<b>High</b>	The alarm will trigger when the input signal is high
<b>Low</b>	The alarm will trigger when the input signal is low

### 12.3.2 Alarm Relay Output

Alarms can operate a specific output (usually a relay). Any individual alarm can operate an individual output or any combination of alarms, up to four, can operate an individual output. They are either supplied pre-configured in accordance with the ordering code or set up in configuration level.

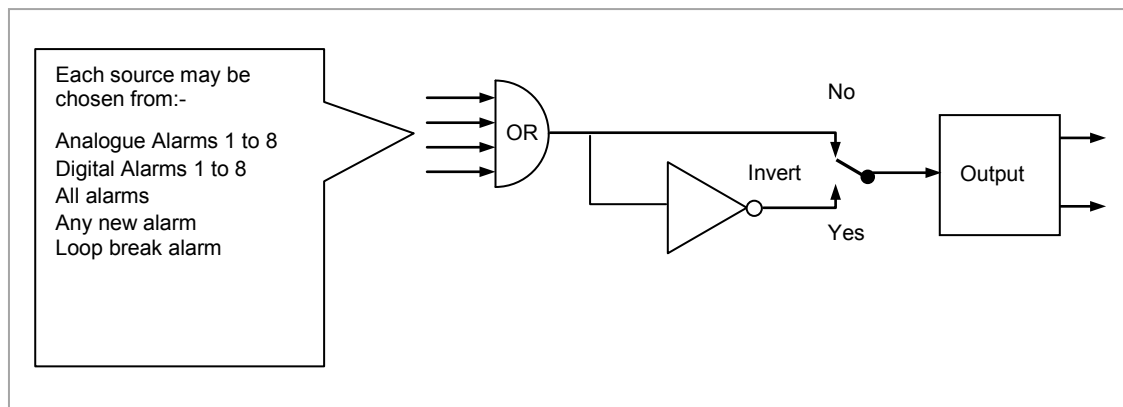

Figure 12-2: Attaching an Alarm to Operate an Output



### 12.3.3 How Alarms are Indicated

- ALM beacon flashing red = a new alarm (unacknowledged)
- This is accompanied by an alarm message. A typical default message will show the source of the alarm followed by the type of alarm. For example, 'AnAlm 1' is the default message for analogue alarm 1.
- Using Eurotherm iTools configuration package, it is also possible to download customised alarm messages. An example might be, 'Process Too Hot' for an analogue alarm or 'Vent open' for a digital alarm (see section 27.9).
- If more than one alarm is present they are listed in the AlmSmry' (Alarm Summary) page.

ALM beacon on continuously = alarm has been acknowledged

Further details of alarm indication are shown in section 2.7.

### 12.3.4 To Acknowledge an Alarm

Press  and  (**Ack**) together as instructed on the display.

The action, which now takes place, will depend on the type of latching, which has been configured.

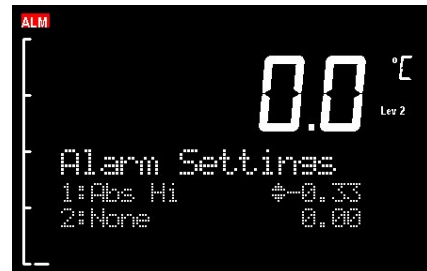

### Non Latched Alarms

As stated above, when an alarm condition occurs a red flashing alarm beacon is displayed accompanied by an alarm message. If a relay has been configured to operate when this alarm occurs (as shown in section 12.3.2.) the relay will relax to the alarm condition (this is the default state for alarm relay outputs). This state will continue for as long as the alarm condition remains.

If the alarm condition disappears before it has been acknowledged all indication will be cancelled and the alarm output relay will reset to the energised non-alarm state.

If the alarm condition is present when the alarm is acknowledged, the red alarm beacon will continuously light, the alarm message will disappear and the output relay will remain in the alarm condition. If the alarm condition is then removed both the red beacon and the relay output will reset.



**Note:** If the 'Invert' parameter found in the Output List is set to 'No' the relay will energise in alarm and be in the de-energised state when no alarm is present. The default setting is 'Yes'.

### Automatic Latched Alarms

The alarm continues to be active until both the alarm condition is removed AND the alarm is acknowledged. The acknowledgement can occur **BEFORE** the condition causing the alarm is removed.

### Manual Latched Alarms

The alarm continues to be active until both the alarm condition is removed AND the alarm is acknowledged. The acknowledgement can only occur **AFTER** the condition causing the alarm is removed.

## 12.4 Analogue Alarm Parameters

Eight analogue alarms are available. Parameters do not appear if the Alarm Type = None. The following table shows the parameters to set up and configure analogue alarms.

List Header: AnAlm		Sub-headers: 1 to 8			
Name ⊙ to select	Parameter Description	Value Press ▼ or ▲ to change values		Default	Access Level
Type	Selects the type of alarm	None Abs Hi Abs Lo Dev Hi Dev Lo Dv Bnd	Alarm not configured Full Scale High Full Scale Low Deviation High Deviation Low Deviation band	As order code	Conf L3 R/O
Input	This is the parameter that will be monitored and compared against the threshold value to see if an alarm condition has occurred	Instrument range			L3
Reference	The reference value is used in deviation alarms and the threshold is measured from this reference and not from its absolute value.	Instrument range			L3
Threshold	The threshold is the value that the input is compared against to determine if an alarm has occurred.	Instrument range			L3
Output	The output indicates whether the alarm is on or off depending on the alarm condition, latching and acknowledge, inhibiting and blocking.	Off On	Alarm output deactivated Alarm output activated		L3 R/O
Inhibit	Inhibit is an input to the Alarm function. It allows the alarm to be switched OFF. Typically the Inhibit is connected to a digital input or event so that during a phase of the process alarms do not activate. For Example, if the door to a furnace is opened the alarms may be inhibited until the door is closed again.	No Yes	Alarm not inhibited Inhibit function active	As order code	L3
Hyst	Hysteresis is used to prevent signal noise from causing the Alarm output to oscillate. Alarm outputs become active as soon as the PV exceeds the Alarm Setpoint. They return to inactive after the PV has returned to the safe region by more than the hysteresis value. Typically the Alarm hysteresis is set to a value that is greater than the oscillations seen on the instrument display	Instrument range			L3
Latch	Determine the type of latching the alarm will use, if any. Auto latching allows acknowledgement while the alarm condition is still active, whereas manual latching needs the condition to revert back to safe before the alarm can be acknowledged. See also the description in section 12.1	None Auto Manual Event	No latching is used Automatic Manual Event		L3
Ack	Used in conjunction with the latching parameter. It is set when the user responds to an alarm.	No Yes	Not acknowledged Acknowledged		L3
Block	Alarm Blocking is used to prevent alarms from activating during start-up. In some applications, the measurement at start-up is in an alarm condition until the system has come under control. Blocking causes the alarms to be ignored until the system is under control (in the safe state), after this any deviations trigger the alarm	No Yes	No blocking Blocking		L3



















List Header: AnAlm		Sub-headers: 1 to 8			
Name ⊙ to select	Parameter Description	Value Press ▼ or ▲ to change values		Default	Access Level
Priority	There are three levels of priority, <i>low</i> , <i>medium</i> and <i>high</i> . When an alarm is triggered a popup is shown on the instrument display. Higher level alarms override lower level ones.	Med	A medium priority alarm will cause a pop-up and supersedes a low priority alarm.	Med	L3
		High	A high priority alarm supersedes both low and medium alarms.		
		Low	A low priority alarm will cause a pop-up.		
Delay	Delay between sensing the alarm condition and displaying it. If in the time between the two, the alarm goes safe, then no alarm is shown and the delay timer is reset. It can be used on systems that are prone to noise.	0:00.0 to 500:00 mm:ss.s hh:mm:ss hhh:mm		0:00.0	L3



### 12.4.1 Example: To Configure Alarm 1

Enter configuration level as described.

Then:-

Do This	The Display You Should See	Additional Notes
1. Press  as many times as necessary to select 'AnAlm'		Up to 8 alarms can be selected using  or  provided they have been enabled in the 'Inst' 'Opt' page
2. Press  to select 'Type' 3. Press  or  to select the required alarm type		Alarm Type choices are:- None Alarm not configured Abs Hi Full Scale High Abs LoFull Scale Low Dev Hi Deviation High Dev LoDeviation Low Dv Bnd Deviation Band
4. Press  to select 'Threshold' 5. Press  or  to set the alarm trip level		This is the alarm threshold setting for. In this example the high alarm will be detected when the measured value exceeds 100.00. The current measured value is 50.00 as measured by the 'Input' parameter. This parameter will normally be wired to an internal source such as the PV.
6. Press  to select 'Hyst' 7. Press  or  to set the hysteresis		In this example the alarm will cancel when the measured value decreases 2 units below the trip level (at 98 units)
Continue to select parameters using  and setting their values using  or 		

## 12.5 Digital Alarm Parameters

Eight digital alarms are available. Parameters do not appear if the Alarm Type = None.

The following table shows the parameters to set up and configure digital alarms.

List Header: DgAlm		Sub-headers: 1 to 8			
Name Ⓞ to select	Parameter Description	Value Press ▼ or ▲ to change values		Default	Access Level
Type	Selects the type of alarm. The alarm will trigger when the condition is reached	None	Alarm not configured	As order code	Conf L3 R/O
		Pos Edge	The input changes from low to high condition		
		Neg Edge	The input changes from high to low condition		
		Edge	Any change of the input condition		
		High	The input signal is high		
		Low	The input signal is low		
Input	The state of the input. This is normally wired to a source	Off On	No alarm Active		L3
Output	The output state of the alarm	Off On	No alarm Active		L3 R/O
Inhibit	Inhibit is an input to the Alarm function. It allows the alarm to be switched OFF. Typically the Inhibit is connected to a digital input or event so that during a phase of the process alarms do not activate.	No Yes	Alarm not inhibited Inhibit function active		L3 R/O if wired
Latch	Same as analogue alarms				L3
Ack	Same as analogue alarms				L3
Block	Same as analogue alarms				L3
Priority	Same as analogue alarms				L3
Delay Only applicable to High and Low alarms	Delay between sensing the alarm condition and displaying it. If in the time between the two, the alarm goes safe, then no alarm is shown and the delay timer is reset. It can be used on systems that are prone to noise.	0:00.0 to 500:00 mm:ss.s hh:mm:ss HHH:mm		0:00.0	L3

## 12.6 Diagnostic Alarms

Diagnostic alarms indicate a possible fault within the controller or connected devices.

Display shows	What it means	What to do about it
E.Conf	A change made to a parameter takes a finite time to be entered. If the power to the controller is turned off before the change has been entered then this alarm will occur. Do not turn the power off to the controller while ConF is flashing	Enter configuration mode then return to the required operating mode. It may be necessary to re-enter the parameter change since it will not have been entered in the previous configuration.
E.CaL	Calibration error	Re-instate Factory calibration
E2.Er	EEPROM error	Return to factory for repair
EE.Er	Non-vol memory error	Make a note of the error and contact your supplier
E.Lin	Invalid input type. This refers to custom linearisation which may not have been applied correctly or may have been corrupted.	Go to the INPUT list in configuration level and set a valid thermocouple or input type

## 12.7 To Set Up Alarms Using iTools

iTools may be used to configure alarms and enter alarm messages. See Chapter 27 for further details.

### 13. Chapter 13 BCD Input

The Binary Coded Decimal (BCD) input function block uses a number of digital inputs and combines them to make a numeric value. A very common use for this feature is to select a setpoint program number from panel mounted BCD decade switches.

The block uses 4 bits to generate a single digit.

Two groups of four bits are used to generate a two digit value (0 to 99)

The block outputs four results



1. Units Value: The BCD value taken from the first four bits (range 0 – 9)
2. Tens Value: The BCD value taken from the second four bits (range 0 – 9)
3. BCD Value: The combined BCD value taken from all 8 bits (range 0 – 99)
4. Decimal Value: The decimal numeric equivalent of Hexadecimal bits (range 0 – 255)

The following table shows how the input bits combine to make the output values.

Input 1	Units value ( 0 – 9)	BCD value (0 – 99)	Decimal value (0 – 255)
Input 2			
Input 3			
Input 4			
Input 5	Tens value ( 0 – 9)		
Input 6			
Input 7			
Input 8			

Since the inputs cannot all be guaranteed to change simultaneously, the output will only update after all the inputs have been stable for two samples.

#### 13.1 BCD Parameters















List Header - BCDIn		Sub-headers: 1 and 2			
Name  to select	Parameter Description	Value Press  or  to change values		Default	Access Level
In 1	Digital Input 1	On or Off	Alterable from the operator interface if not wired	Off	L3
In 2	Digital Input 2	On or Off		Off	L3
In 3	Digital Input 3	On or Off		Off	L3
In 4	Digital Input 4	On or Off		Off	L3
In 5	Digital Input 5	On or Off		Off	L3
In 6	Digital Input 6	On or Off		Off	L3
In 7	Digital Input 7	On or Off		Off	L3
In 8	Digital Input 8	On or Off		Off	L3
Dec Value	Decimal value of the inputs	0 – 255	See examples below		L3 R/O
BCD Value	Reads the value (in BCD) of the switch as it appears on the digital inputs	0 – 99	See examples below		
Units	Units value of the first switch	0 – 9	See examples below		L3 R/O
Tens	Units value of the second switch	0 – 9	See examples below		L3 R/O

In 1	In 2	In 3	In 4	In 5	In 6	In 7	In 8	Dec	BCD	Units	Tens
1	0	0	0	0	0	0	0	1	1	1	0
1	1	1	1	0	0	0	0	15	9	9	0
0	0	0	0	1	1	1	1	240	90	0	9
1	1	1	1	1	1	1	1	255	99	9	9

### 13.1.1 Example: To wire a BCD Input

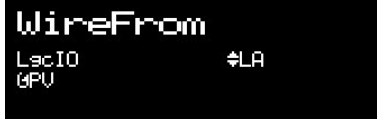
The BCD digital input parameters may be wired to digital input terminals of the controller.

There are two standard digital input terminals which may be used (LA and LB), but it may also be necessary to use a triple digital input module in addition. The wiring procedure is the same and the example given below wires BCD input 1 to LA.

Do This	The Display You Should See	Additional Notes
1. From any display press  until the 'BCDIn' page is reached 2. Press  or  to select '1' or '2' as required		In this example BCD block 1 is used.
3. Press  to scroll to 'In1'		
4. Press  to display 'WireFrom'		
5. Using  and  select the parameter which is to be wired from. In this example Logic input LA		PV is the parameter required and this procedure 'copies' the parameter to be wired from
6. Press 		
7. Press  to confirm		This 'pastes' the parameter to 'In1' The arrow next to the parameter indicates that it has been wired

## 14. Chapter 14 Digital Communications

Digital Communications (or 'comms' for short) allows the controller to communicate with a PC or a networked computer system or any type of communications master using the protocols supplied. A data communication protocol defines the rules and structure of messages used by all devices on a network for data exchange. Communications can be used for many purposes – SCADA packages; plcs; data logging for archiving and plant diagnostic purposes; cloning for saving instrument set ups for future expansion of the plant or to allow you to recover a set-up after a fault.

This product supports the following protocols:-

Protocol	For a full description of these protocols please refer to the relevant published standards but further details may be found in:-
MODBUS RTU ®	Series Communications Handbook part no. HA026230; Section 14.3.2 and Appendix A of this handbook. A full description can be found on <a href="http://www.modbus.org">www.modbus.org</a> .
DeviceNet	DeviceNet Communications Handbook part no. HA027506; Section 14.3.2 of this handbook
Profibus	Profibus Communications Handbook part no. HA026290; Section 14.3.2 of this handbook
EI-Bisynch	Series Communications Handbook part no. HA026230; 800 Series Communications Handbook part no. HA020161; 900 Series Communications Handbook part no. HA023776; Section 14.3.2 and Appendix B of this handbook
Modbus TCP (Ethernet)	Section 14.4 of this handbook. A full description of the Modbus TCP protocol can be found on <a href="http://www.modbus.org">www.modbus.org</a> .

There are two communications ports available within the instrument; these are defined as the 'H' and 'J' ports and act as a communications slave. Various communications modules each supporting a different protocol may be fitted to each port as follows:-

Port	ModBus	EI-Bisynch	DeviceNet	Profibus	Ethernet
H	✓	✓	✓	✓	✓
J	✓	✓	X	X	X

Wiring connections for each of these protocols is given in Chapter 1.



**Note:** When using DeviceNet with instrument firmware version 1.10 and greater, the DeviceNet module must have the part no. AH027179U003.

## 14.1 Serial Communications

ModBus and EI-Bisynch use EIA232 and EIA485 2-wire serial communications. The wiring connections for these and the other protocols are given in section 1.8.

### 14.1.1 EIA232

EIA232 uses a three wire cable (Tx, Rx, Gnd). The signals are single ended, i.e. there is a single wire for transmit and another for receive. This makes EIA232 less immune to noise in industrial applications. EIA232 can only be used with one instrument. To use EIA232 the PC will be equipped with an EIA232 port, usually referred to as COM 1.

To construct a cable for EIA232 operation use a three core screened cable.

The terminals used for EIA232 digital communications are listed in the table below. Some PC's use a 25 way connector although the 9 way is more common.

Standard Cable Colour	PC socket pin no.		PC Function *	Instrument Terminal	Instrument Function
	9 way	25 way			
White	2	3	Receive (RX)	HF or JF	Transmit (TX)
Black	3	2	Transmit (TX)	HE or JE	Receive (RX)
Red	5	7	Common	HD or JD	Common
Link together	1 4 6	6 8 11	Rec'd line sig. detect Data terminal ready Data set ready		
Link together	7 8	4 5	Request to send Clear to send		
Screen		1	Ground		

\* These are the functions normally assigned to socket pins. Please check your PC manual to confirm.

### 14.1.2 EIA485

The EIA485 standard allows one or more instruments to be connected (multi dropped) using a two wire connection, with cable length of less than 1200M. 31 instruments and one master may be connected. The balanced differential signal transmission is less prone to interference and should be used in preference to EIA232 in noisy environments. EIA485 may be used with Half Duplex Communications such as MODBUS RTU.

To use EIA485, buffer the EIA232 port of the PC with a suitable EIA232/EIA485 converter. The Eurotherm KD485 Communications Adapter unit is recommended for this purpose. The use of a EIA485 board built into the computer is not recommended since this board may not be isolated, which may cause noise problems or damage to the computer, and the RX terminals may not be biased correctly for this application.

To construct a cable for EIA485 operation use a screened cable with one (EIA485) twisted pair plus a separate core for common. Although common or screen connections are not necessary, their use will significantly improve noise immunity.

The terminals used for EIA485 digital communications are listed in the table below.

Standard Cable Colour	PC Function *	Instrument Terminal	Instrument Function
White	Receive (RX+)	HF or JF (B) or (B+)	Transmit (TX)
Red	Transmit (TX+)	HE or JE (A) or (A+)	Receive (RX)
Green	Common	HD or JD	Common
Screen	Ground		

\* These are the functions normally assigned to socket pins. Please check your PC manual to confirm.

## 14.2 Configuration Ports

In addition to the above communications the 'H' port also supports infrared (IR Clip) and configuration (CFG Clip) communications see also Chapter 27. These interfaces always adhere to default settings regardless of the 'H' port set up. These are:-

- ModBus protocol
- Instrument address 255
- Baud rate 19K2
- No parity

### 14.2.1 IR Clip

An IR Clip, available from Eurotherm, clips to the front of the controller as shown. It is enabled/disabled via the "IR Mode" parameter within the "Access" page of the instrument. When enabled the IR communications override all standard 'H' port communications. None of the standard communications detailed above will be responded to while IR Mode is enabled. 'H' port activities will not interfere with IR Clip communications.



Fitting of the CFG clip is the only communications mechanism that overrides IR clip communications.

### 14.2.2 CFG Clip

A configuration clip is also available from Eurotherm which interfaces directly with the main printed circuit board in the controller. It can be clipped into position with the controller in or out of its sleeve. The CFG Clip is automatically detected when connected but should not be used while 'H' port communications are active. The CFG clip must be powered externally to ensure detection and may be used to power the instrument or while the instrument is already powered.



The Ethernet and DeviceNet communications module should not be fitted while using the CFG Clip as communications conflicts will occur. This is because both the DeviceNet and Ethernet Communications Modules maintain constant messaging between themselves and the instrument even when no external messages are being received.

The CFG clip may be used while EIA232/EIA485/Profibus communications modules are fitted but it is not recommended that communications are active on these modules while the CFG clip is in use as conflicts may occur.

Fitting of the CFG clip while the IR clip is in use will result in the IR communications being overridden and the CFG clip communications accepted.

### 14.2.3 USB CPI Clip

From May 2013 the above clip has been replaced by a USB clip. It is designed to clip into the side of the controller in the same way as the previous item and can be used with the instrument powered or un-powered and with the instrument mounted or un-mounted in its sleeve. The clip is intended to be used with the Eurotherm configuration package, iTools. It may be ordered as ITOOLS/NONE/USB.

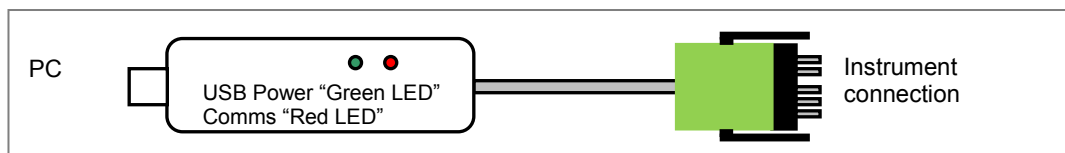



#### 14.2.4 Cloning of Configuration Port Settings





Full instrument cloning is supported via the CFG clip without the need for instrument power although errors may be reported with I/O module settings. This is because the modules are not powered so confirmation of downloaded settings is not possible. If the IR comms port is used during cloning then parameters associated with both J and H ports are cloned.

If the H port is used then the J port settings are cloned but not the H port settings.

If the J port is used then the H port settings are cloned but not the J port settings.

### 14.3 Digital Communications Parameters

Digital communications parameters may be found in the 'Comms' page. Communications modules may be fitted in the 'H' slot or 'J' slot. The following table shows the parameters available in each position.

List Header - Comms		Sub-headers: H and J			
Name  to select	Parameter Description	Value Press  or  to change values		Default	Access Level
Ident	Identifies that the comms module is fitted in the H or J slot. See section 14.3.1	None IOExp Comms	No module fitted IO expander (J slot only) Communications module fitted	As ordered	R/O
Protocol	Digital communications protocol See section 14.3.2	MODBUS MBUS_M EIBISYNCH Profibus DeviceNet Ethernet	Modbus Modbus Master - Firmware versions 2.90 and above EIBISYNCH Profibus DeviceNet Ethernet	MODBUS	Not available in J slot
Baud Rate	Communications baud rate Not applicable to Profibus or Ethernet See section 0	Modbus/EI-Bisynch 4800 9600 19,200	Devicenet 125K 250K 500K	9600 EI-Bi 19K2 Mod 125K Dnet	Conf L3 R/O
Parity	Communications parity (not applicable to Devicenet or Profibus). See section 14.3.4	None Even Odd	No parity Even parity Odd parity	None (Even EIBisynch)	Conf L3 R/O
Address	Instrument address See section 14.3.5	1 to 254 Modbus/EI-Bisynch 0 to 126 Profibus 0 to 63 Devicenet		1	L3
Resolution	Comms resolution (Modbus only)	Full Integer	Full Integer	Full	Conf
Network	Network Status, Profibus and DeviceNet only. Displays status of the network and connection	Ready Offline Running Init	Profibus or DeviceNet Network connected and working Network not connected Ethernet connected Profibus or DeviceNet Initialising		R/O
Comms Delay	Rx/Tx delay time (not applicable to Devicenet or Profibus) See section 14.3.6	No Yes	No delay Fixed delay. This inserts a delay between Rx and Tx to ensure that the drivers used by intelligent EIA232/EIA485 converters have sufficient time to switch over.	No	Conf L3 R/O
H Activity	Comms activity in H or J module	0 or 1			
Broadcast See section 14.8	To enable broadcast master communications. This is only applicable for Modbus protocol.	No Yes	Not enabled Enabled	No	
Dest Addr  See section 14.8	Address of the parameter being written to slaves. eg, to write to power output set the value to 3, the Modbus address of the parameter being written to.	0 to 32767			

List Header - Comms		Sub-headers: H and J			
Name Ⓞ to select	Parameter Description	Value Press ▼ or ▲ to change values		Default	Access Level
Bcast Val See section 14.8	Value to be sent to instruments on the network. Normally wired to a parameter within the 3500 master	Range of the parameter wired. In the case of a Boolean the value will be 0 or 1.			
Wdog Flag	Network Watchdog Flag This flag is ON when the Network communications have stopped addressing the instrument for longer than the Timeout time. It will be set by the Watchdog process and may be cleared Automatically or Manually according to the value of the Watchdog Action parameter.	Off On		Off	R/O
Wdog Action	Network Watchdog Action The Watchdog Flag may be cleared Automatically upon reception of valid messages or Manually by a parameter write or a wired value.	ManRec	Manual Recovery The Watchdog Flag must be cleared manually - either by a parameter write or a wired value.	ManRec	Conf L3 R/O
		AutoRec	Automatic Recovery The Watchdog Flag will be automatically cleared when the Network Communications resume - according to the value in the Recovery Timer.		
Wdog Timeout	Network Watchdog Timeout If the Network communications stop addressing the instrument for longer than this value, the Watchdog Flag will become active.	0.0 to 60.0 seconds	A value of 0.0 disables the watchdog.	0.0	Conf L3 R/O
WdogRecy	Network Watchdog Recovery This is only shown when the Watchdog Action is set to Auto. This timer determines the delay after resumption of communications before the Watchdog Flag is cleared. A value of 0 will reset the Watchdog flag upon the first valid message received. Other values will wait for at least 2 valid messages to be received within the set time before clearing the Watchdog flag.	0.0 to Wdog Timeout		0.0	Conf L3 R/O

If 'Protocol' is set to 'Ethernet' refer to section 14.4.1. for available parameters.

If 'Protocol' is set to 'Profibus' refer to section 14.5.1 for available parameters.

If 'Protocol' is set to 'Devicenet' refer to section 14.6.1 for available parameters.

If 'Protocol' is set to 'MBUS\_M' refer to section 14.9.2 for available parameters.

The watchdog parameters are also included for Ethernet and Devicenet.

### 14.3.1 Communications Identity

The identity 'id' shows that a communications board is fitted or not.

### 14.3.2 Protocol

#### 14.3.2.1 Modbus (Jbus) Protocol

MODBUS defines a digital communication network to have only one MASTER and one or more SLAVE devices. Either a single or multi-drop network is possible. All message transactions are initiated by the MASTER. Eurotherm instruments communicate using the Modbus RTU binary protocol.

The JBUS protocol is identical in all respects but '1' is added to the MODBUS protocol parameter or register address. Both use a numeric index but the JBUS index starts at '0' while the MODBUS index starts at '1'.

Modbus is available in the 'H' or the 'J' port modules. 3500 series instruments have a fixed table of addresses referred to as the SCADA table which are designed for use with SCADA or PLC packages. A full list of these addresses is given in Appendix A. Every parameter may be addressed from the iTools OPC server using the OPC name.

#### 14.3.2.2 Devicenet Protocol

DeviceNet is a cost-effective communications link designed to replace hardwired I/O interconnection between industrial devices.

Devicenet is simple to use through the application of automated software configuration tools and simple wiring layouts. Engineering cost and time to design, configure and commission a DeviceNet installation is significantly less than other comparable networks. Devicenet is an Open Standard and is now used by a wide range of vendors. Common definition of simple devices allows interchangeability while making interconnectivity of more complex devices possible. In addition to reading the state of discrete devices, DeviceNet allows easy access to operating node variables such as process temperatures, alarm status as well as system diagnostic status.

The DeviceNet communication link is based on a broadcast- oriented, communications protocol the Controller Area Network (CAN).

**The minimum revision for DeviceNet communications module software used with the 3500 instruments is revision 1.6. This is identified by the module part no. AH027179U003.**

#### 14.3.2.3 Profibus DP

This 'fieldbus' system allows very high speed digital communications using an enhanced EIA485 wiring technology, and has become a de facto standard in factory and process automation.

The 3500 series controllers use Profibus DP which is designed for fast, cyclic, transfer of time critical data from intelligent devices such as temperature controllers, I/O units, drives, etc to a PLC or PC based controller, with a scan time of around 10mS. Applications are typically in industrial automation, such as extrusion, bottling, and baking, amongst many others.

#### 14.3.2.4 EI-Bisynch Protocol

EI-Bisynch is a proprietary Eurotherm protocol based on the ANSI X3.28-2.5 A4 standard for message framing. Despite its name, it is an ASCII based asynchronous protocol. Data is transferred using 7 data bits, even parity, 1 stop bit (this may be changed in the controller).

EI-Bisynch identifies parameters within an instrument using what are known as 'mnemonics'. These are usually two letter abbreviations for a given parameter, for example, PV for Process Variable, OP for Output, SP for Setpoint, and so on.

EI-BiSync communications within the 3500 series instruments allows for the reading/writing of a number of parameters over EIA232 or EIA485 communications using the parameter's mnemonic as a reference and the 818 & 902/3/4 style EI-BiSync communications protocol. This does not include 900EPC controllers.

EI-BiSync is available in the 'H' or the 'J' port modules and has been included in this instrument for backward compatibility. Where mnemonic conflicts occur, the 818 mnemonic takes priority.

The mnemonics are the same as the 818 & 902/3/4 controllers and these are shown in Appendix B together with a description of the parameter in both series of controllers.

#### 14.3.2.5 Ethernet (Modbus TCP)

See section 14.4.

#### 14.3.2.6 Modbus Master (MBUS\_M)

See section 14.9.

**14.3.3 Baud Rate**

The baud rate of a communications network specifies the speed that data is transferred between instrument and master. A baud rate of 9600 equates to 9600 Bits per second. Since a single character requires 8 bits of data plus start, stop, and optional parity, up to 11 bits per byte may be transmitted. 9600 baud equates approximately to 1000 Bytes per second. 4800 baud is half the speed – approx. 500 Bytes per second.

In calculating the speed of communications in your system it is often the Latency between a message being sent and a reply being started that dominates the speed of the network.

For example, if a message consists of 10 characters (10msec at 9600 Baud) and the reply consists of 10 characters, then the transmission time would be 20 msec. However, if the Latency is 20msec, then the transmission time has become 40msec.

**14.3.4 Parity**

Parity is a method of ensuring that the data transferred between devices has not been corrupted.

Parity is the lowest form of integrity in the message. It ensures that a single byte contains either an even or an odd number of ones or zero in the data.







In industrial protocols, there are usually layers of checking to ensure that the first byte transmitted is good. Modbus applies a CRC (Cyclic Redundancy Check) to the data to ensure that the package is correct.

**14.3.5 Communication Address**

On a network of instruments an address is used to specify a particular instrument. Each instrument on a network should have a unique address. Address 255 (and address 244 when using Ethernet) is reserved for factory use.

**14.3.5.1 Example:- To Set Up Instrument Address**

This can be done in operator level 3:-

Do This	The Display You Should See	Additional Notes
1. Press  as many times as necessary to select 'Comms'		
2. Press  to scroll to 'Address' 3. Press  or  to select the address for the particular controller		Up to 254 can be chosen but note that no more than 31 instruments should be connected to a single EIA485 link.  For further information see 2000 Series Communications Handbook Part No. HA026230 available on <a href="http://www.eurotherm.co.uk">www.eurotherm.co.uk</a>

**14.3.6 Comms Delay**

In some systems it is necessary to introduce a delay between the instrument receiving a message and its reply. This is sometimes caused by communications converter boxes which require a period of silence on the transmission to switch over the direction of their drivers.

### 14.3.7 818, 902/3/4 Style Programmer

Mnemonics have also been included within the protocol to support 818, 902/3/4 style programs.

The functionality of these mnemonics is only assured for use with the programmer when it is configured for 818 style programs. These consist of 8 x Ramp/Dwell pairs (16 segments - Ramp, Dwell, Ramp, Dwell etc).

The mnemonics l1-l8 are used to read/set the target set points for the first 8 ramp segments. Mnemonics r1-r8 are used to read/set the ramp rates for the first 8 ramp segments and the mnemonics t1-t8 are used to read/set the segment duration for the first 8 dwell segments. Mnemonics 01-06 are used to poll or configure the digital event outputs per segment.

Configuring the programmer with a non 818 style program will not produce consistent results as mnemonics l1-l8 represent segments 1, 3, 5, 7, 9, 11, 13 & 15. Mnemonics t1-t8 represents segments 2, 4, 6, 8, 10, 12, 14 & 16.

#### 14.3.7.1 Reading/Setting Segment Types.

The r1-r8 mnemonics can be used to change/read rate segment types (first 8 odd numbered segments) by using negative values. A value of zero represents a step segment, a value of -1 represents an un-configured segment (within the evolution products this results in a segment type of dwell with zero time - effectively a non-segment) and values of -2 for an End segment.

The resolution of these mnemonics is again defined by the resolution of Loop-PV. The values are scaled accordingly so a Loop-PV resolution giving 2 decimal places will show a value of -0.02 for an end segment (or 0-02 in fixed format mode).

#### 14.3.7.2 Program Selection

Character 'B' (>ABCD) of mnemonic SW (Status word) represents the currently selected program number. This nibble can be written to, to select the current program, or read from to determine the currently selected program. This is limited to 15 programs (being a single nibble). If a program greater than 15 is selected within the instrument then this byte will return a value of 0.

### 14.3.8 Status Words



818 & 902/3/4 Status words have been made available within this instrument. The bits within these words are used to read/write to particular parameters within the instrument. As the status words are used to write to many parameters simultaneously, no errors are reported if a particular bit fails the write operation. When changing parameters using the status words, the status word should be read-back to check the required changes occurred.

Please see the appendix for details of the status word bits.

## 14.4 Ethernet Protocol

If 'Protocol' is set 'Ethernet' the following parameters are available.

### 14.4.1 Ethernet Parameters

List Header - Comms		Sub-header: H only			
Name  to select	Parameter Description	Value Press  or  to change values		Default	Access Level
Ident	Identifies that the comms module is fitted	None Comms	No module fitted Communications module fitted		R/O
Protocol	Digital communications protocol	Ethernet			
Address	Instrument address	1 to 253		1	
Wdog Flag	See section 14.3 for an explanation.	On/Off		Off	R/O
Wdog Action		ManRec/AutoRec		ManRec	Conf L3 R/O
Wdog Timeout		0.0 to 60.0 seconds		0.0	
WdogRecy		0.0 to Wdog Timeout		0.0	
Unit Ident	Unit Identifier enable/disable.	Strict Loose Instr	See section 14.4.10 for further explanation	Strict	Conf
DHCP enable	See section 14.4.4	Fixed Dynamic		Fixed	
IP Address 1	See section 14.4.2	0 to 255		192	
IP Address 2		0 to 255		168	
IP Address 3		0 to 255		111	
IP Address 4		0 to 255		222	
Subnet mask 1		0 to 255		255	
Subnet mask 2		0 to 255		255	
Subnet mask 3		0 to 255		255	
Subnet mask 4		0 to 255		0	
Default GW 1				0	
Default GW 2				0	
Default GW 3				0	
Default GW 4				0	
Pref mstr IP 1	See section 14.4.8			0	
Pref mstr IP 2				0	
Pref mstr IP 3				0	
Pref mstr IP 4				0	
Show MAC	See section 14.4.3	No; Yes		No	
Network	Status of network	Running Offline	Network connected and working Network not connected or working		R/O

### 14.4.2 Instrument setup



**Note:** It is recommended that you setup the communications settings for each instrument *before connecting it to any Ethernet network*. This is not essential but network conflicts may occur if the default settings interfere with equipment already on the network. By default the instruments are set to a fixed IP address of 192.168.111.222 with a default SubNet Mask setting of 255.255.255.0.



**Note:** IP Addresses are usually presented in the form "xxx.xxx.xxx.xxx". Within the instrument *each element of the IP Address is shown and configured separately*.

"IP address 1" relates to the first set of three digits, IP address 2 to the second set of three digits and so on. This also applies to the SubNet Mask, Default Gateway and Preferred master IP Address.

#### 14.4.3 MAC address display

Each Ethernet module contains a unique MAC address, normally presented as a 12 digit hexadecimal number in the format "aa-bb-cc-dd-ee-ff".

In the **3500** instruments MAC addresses are shown as 6 separate hexadecimal values in the "COMMS" page. MAC1 shows the first pair of digits (example "0xAA"), MAC2 shows the second pair of digits and so on.

The MAC address can be found by powering up the instrument and navigating to the "**COMMS**" page. At the bottom of the "**COMMS**" page you will find a 'Show Mac' parameter. Set this parameter to 'Yes' and the MAC address of the Ethernet communications card fitted will appear in the list.

#### 14.4.4 DHCP Settings

You need to consult with your network administrator to determine if the IP Addresses for the instruments should be fixed or Dynamically allocated by a DHCP server.

If the IP Addresses are to be dynamically allocated then all MAC addresses must be supplied to the network administrator.

For fixed IP Addresses the Network Administrator will provide the IP address as well as a SubNet Mask. These must be configured into the instrument during set-up through the "COMMS" page. Remember to note the allocated addresses.

#### 14.4.5 Network Connection

Screw the "RJ45" adapter into the instrument "H" port, as shown in section 1.8.4. Use standard CAT5 cable to connect to the Ethernet 10BaseT switch or hub. Use cross-over cable only if connecting one-to-one with a PC acting as network master.

#### 14.4.6 Dynamic IP Addressing

Within the "**Comms**" page of the instrument set the "**DHCP enable**" parameter to "**Dynamic**". Once connected to the network and powered, the instrument will acquire its "IP address", "SubNet Mask" and "Default gateway" from the DHCP Server and display this information within a few seconds.

#### 14.4.7 Fixed IP Addressing

Within the "**Comms**" page of the instrument ensure the "**DHCP enable**" parameter is set to "**Fixed**", then set the IP address and SubNet Mask as required (and defined by your network administrator).

#### 14.4.8 Additional information

1. The "**Comms**" page also includes configuration settings for "**Default Gateway**", these parameters will be set automatically when Dynamic IP Addressing is used. When fixed IP addressing is used these settings are only required if the instrument needs to communicate wider than the local area network i.e. over the internet – see your network administrator for the required setting.
2. The "**Comms**" page also includes configuration settings for "**Preferred Master**". Setting this IP address to the IP Address of a particular PC will guarantee that one of the 4 available Ethernet sockets will always be reserved for that PC (reducing the number of available sockets for anonymous connections to 3).

#### 14.4.9 iTools Setup

iTools configuration package, version V5.60 or later, may be used to configure Ethernet communications.

The following instructions configure Ethernet.

To include a Host Name/Address within the iTools scan:-

1. Ensure iTools is **NOT** running before taking the following steps
2. Within Windows, click **'Start'**, then **'Settings'**, then **'Control Panel'**
3. In control panel select **'iTools'**
4. Within the iTools configuration settings select the **'TCP/IP'** tab
5. Click the **'Add'** button to add a new connection
6. Enter a name for this TCP/IP connection
7. Click the **'Add'** button to add the host name (details from your network administrator) or IP address of the instrument in the **'Host Name/ Address'** section
8. Click **'OK'** to confirm the new Host Name/IP Address you have entered
9. Click **'OK'** to confirm the new TCP/IP port you have entered
10. The TCP/IP port configured within the TCP/IP tab of the iTools control panel settings should now be seen

iTools is now ready to communicate with an instrument at the Host Name/IP Address you have configured

#### 14.4.10 Unit Ident Enable

The Modbus TCP Specification includes the 'normal' Modbus address as part of the packaged Modbus message – where it is called the Unit Identifier. If such a message is sent to an Ethernet to Serial gateway, the 'Unit Ident' is essential to identify the slave instrument on the serial port. When a stand alone Ethernet instrument is addressed, however, the 'Unit Ident' is not required since the IP address fully identifies the instrument. To allow for both situations the 'Unit Ident Enable' parameter is used to enable or disable checking of the Unit Ident received from TCP. The enumerations produce the following actions:-

- 'Instr': The received Unit Ident must match the Modbus address in the instrument or there will be no response.
- 'Loose': The received Unit Ident value is ignored, thus causing a reply regardless of the received 'Unit Ident'.
- 'Strict': The received Unit Ident value must be 0xFF or there will be no reply



## 14.5 Profibus Protocol

Profibus DP is an industry standard open network used to interconnect instrumentation and control devices in, for example, a manufacturing or processing plant. It is often used to allow a central Programmable Logic Controller (PLC) or PC based control system to use external 'slave' devices for input/output (I/O) or specialised functions, thus reducing the processing load on the controlling unit so that its other functions can be carried out more efficiently using less memory.

The Profibus network uses a high speed version of the EIA485 standard (see also section 14.1.2), and permits transmission rates of up to 12M Baud (1.5MB in 3500) between the host and up to 32 Profibus 'Stations' or 'nodes' within a single section of a network. The use of repeaters allows the maximum of 127 nodes (addresses 0 to 126) to be supported.

Profibus DP distinguishes between master and slave devices. It allows slave devices to be connected on a single bus thus eliminating considerable plant wiring.

**Master devices** determine the data communications on the bus. A master can send messages without an external request when it holds the bus access rights (the token). Masters are also called active stations in the Profibus protocol.

**Slave devices** are peripheral devices such as I/O modules, valves, temperature controllers/indicators, and measuring transmitters. 3500 units are intelligent slaves which will only respond to a master when requested to do so.

Profibus DP is based around the idea of 'cyclical scan' of devices on the network, during which 'input' and 'output' data for each device is exchanged.

3500 series controllers are configured for Profibus communications using .gsd files which may be edited to change the data mapping view. Details of the GSD editor may be found in section 14.5.5.

It is not within the scope of this document to describe the Profibus standard in detail. This may be found by reference to [www.profibus.com](http://www.profibus.com).

### 14.5.1 Profibus Parameters

If 'Protocol' is set to 'Profibus' in configuration level the following parameters are available.

List Header - Comms		Sub-header: H only			
Name Ⓞ to select	Parameter Description	Value Press ▼ or ▲ to change values		Default	Access Level
Ident	Identifies that a comms module is fitted	Comms None	Communications module fitted None is shown if no comms module is fitted or is subsequently removed.		R/O
Protocol	Digital communications protocol	Profibus			Conf R/O in L3
Address	Instrument address	0 to 126		1	L3
Network	Comms network status	Running	Network connected and operational		R/O
		Init	Network initialising		
		Ready	Network ready to accept connection		
		Offline	Network offline		
		Bad	Network status bad GSD		
Wdog Flag	See section 14.3 for further details.	On/Off		Off	R/O
Wdog Action		ManRec/AutoRec		ManRec	Conf R/O in L3
Wdog Timeout		0.0 to 60.0 seconds		0.0	
WdogRecy		0.0 to Wdog Timeout		0.0	

**14.5.2 I/O Data Exchange**

The process of reading the inputs and writing to the outputs is known as an I/O data exchange. Typically, the parameters from each slave device will be mapped to an area of PLC input and output registers, or a single function block, so that the controlling ladder logic, or program, interfaces with the device as if it were an internally fitted module.

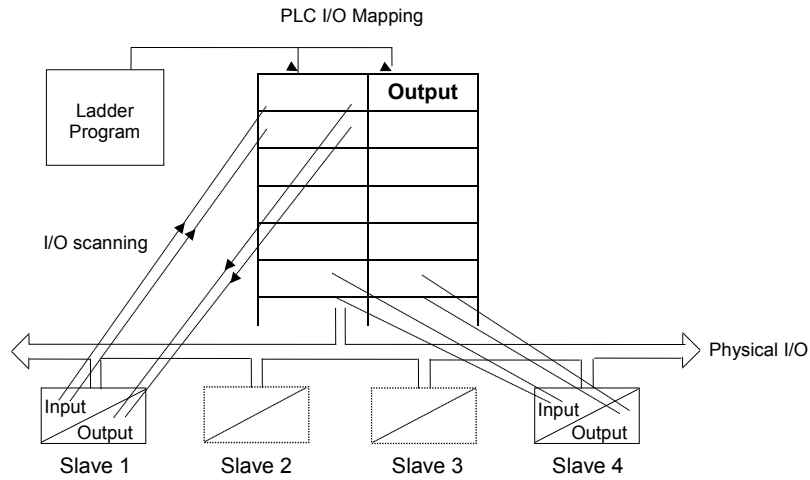

**14.5.3 Network Configuration**

The master PLC or PC based supervisory package must be configured to set-up the parameters that it will be able to read and write to. This is known as 'network configuration'.

For Profibus-DP, the characteristic features of an instrument are stored in an ASCII device data file called the GSD file. GSD files are used by Profibus configuration tools to enable a master Profibus scanner module – for example a PLC or PC - to know what slave devices are to be communicated to, their node address, what parameters can be read and written to and more.

In addition to standard GSD files, Eurotherm Profibus products are supported by the unique Eurotherm Profibus GSD file editor that provides a simple way of mapping device parameters into the input/output registers of a plc or supervisory package (master). This 32-bit Windows based software allows drag and drop of instrument parameters from a tabbed list into input and output windows for automatic generation of the GSD file.

### 14.5.4 To Install the Eurotherm GSD Editor

This software is available from the CD supplied with iTools or from <http://www.eurotherm.co.uk/profibus/>.

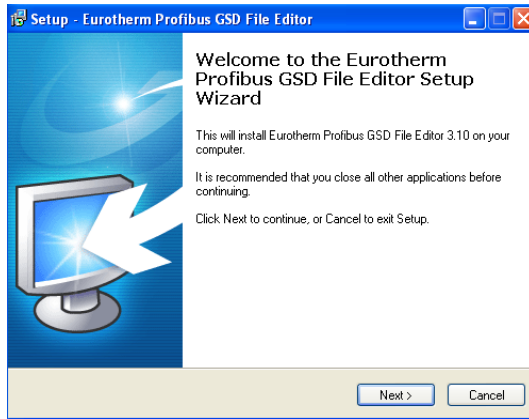

Download the file 'Profibus GSD Editor'. (A version number is generally given, e.g. 3.10).

Save the file 'setup\_gsdedit\_310.exe' to a suitable location and double click it to Run.

Select a file location and press 'Next'.

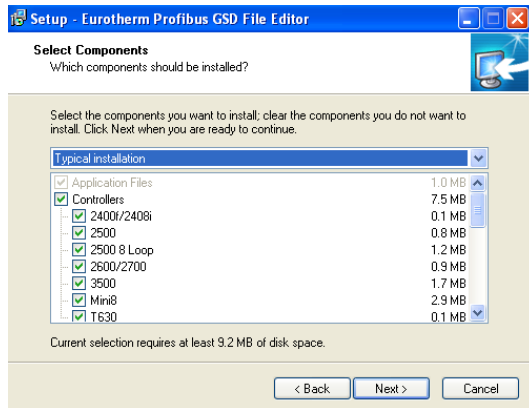
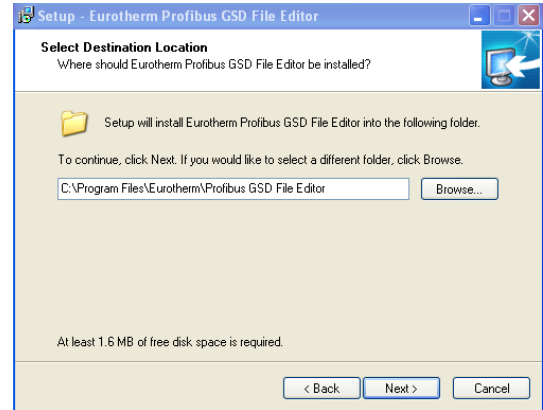

Choose which products are to be included in the GSD editor.

Select where Setup should place program short cuts, then press 'Next'.

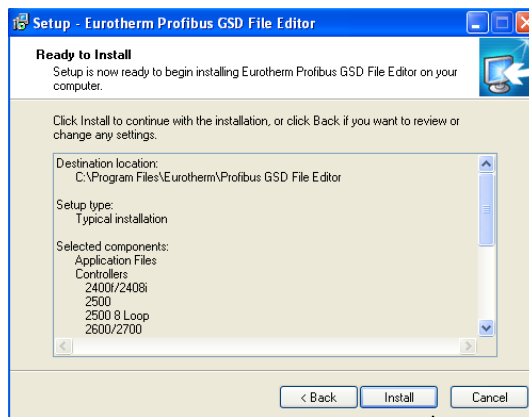
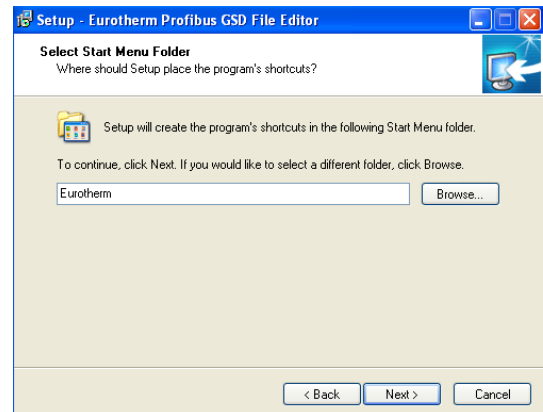

Press Install

Press Finish to exit Setup.



14.5.5 Launch the GSD Editor

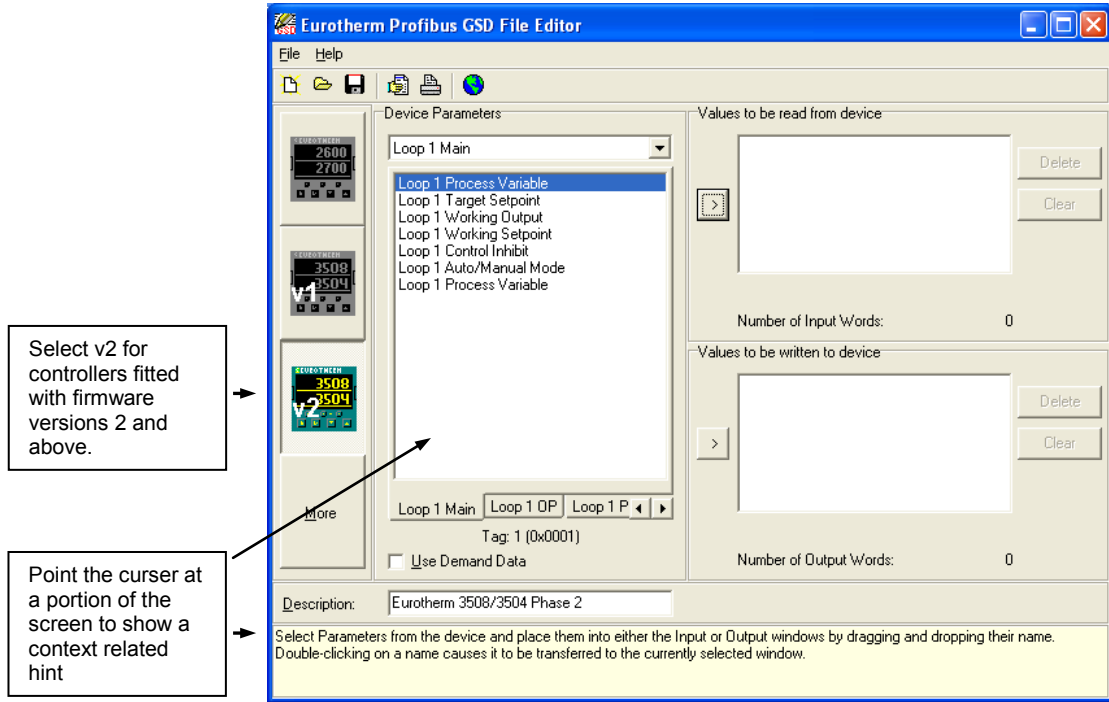

To add a parameter to the PROFIBUS-DP Input Data, simply drag it from the Device Parameter list using the mouse, and drop it into the Inputs list. Similarly, drop a parameter into the Outputs list to set PROFIBUS-DP Output Data.

Alternatively, double click on a parameter name to add it to the currently selected window - select the list by clicking on it - or use the arrow button to the left of the input and output lists. The order of the parameters in the Input and Output List may be changed by dragging and dropping between them. Parameters may be deleted or the list cleared using the buttons on the right hand side of the I/O lists, or by pressing the right mouse button when the cursor is over a parameter name, whereupon a pop up menu will be displayed.

Parameters are found in feature related lists in a similar way to the parameter lists in the instrument. The lists are chosen alphabetically using the drop down box under Device Parameters or by using the tabs below the window.

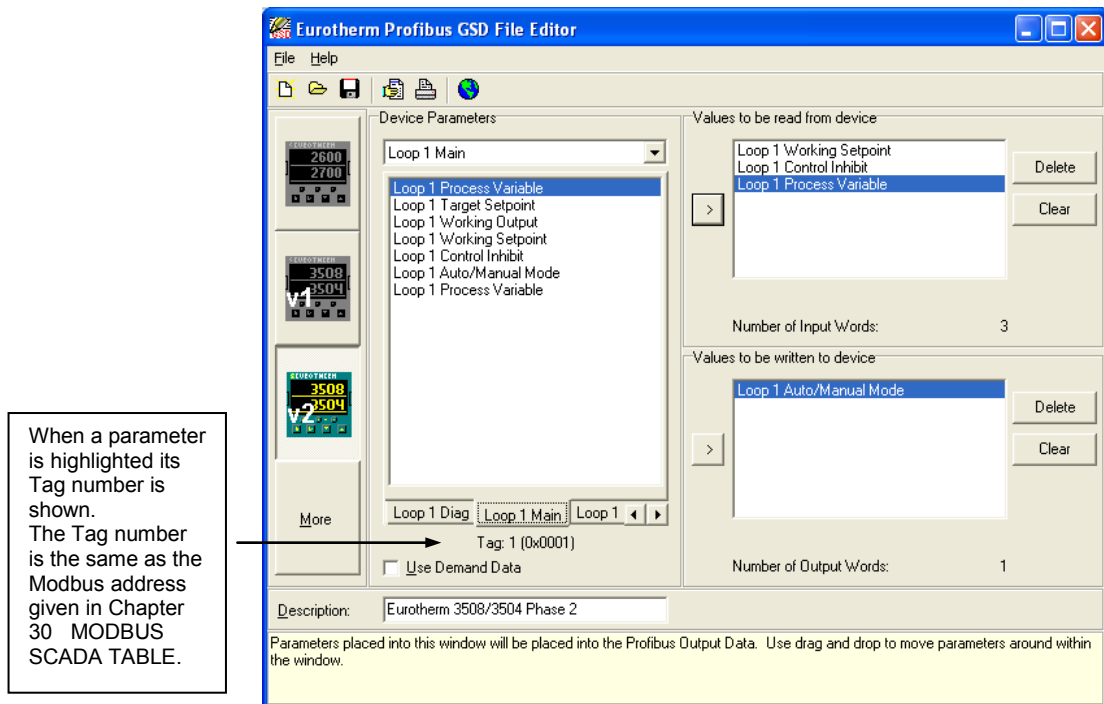

**Example:**

Produce a GSD file to allow gain scheduling using a PID settings stored in a PLC

**Input Data**

- Process Variable

**Output Data:**

- Proportional Band
- Integral Time
- Derivative Time
- Cutback High
- Cutback Low

In this application, the PLC monitors 'Process Variable' (actual temperature), and when it passes into a particular pre-set band, sets the output data parameters from settings stored in the PLC.

A limit of 117 **total** input and output words, including the requirements for demand data, is imposed by the configurator. When this limit is reached, it will no longer be possible to add parameters into either the input or output lists until other parameters have been deleted.



**Note:** Some masters are unable to deal with more than 32 inputs and 32 outputs.

To obtain a summary of the I/O memory map for the current GSD file, select 'View I/O map' from the file menu. This may be pasted into the clipboard and placed into a document if required for project documentation. It may also be printed directly from the File menu.

Once the I/O data has been specified to your wishes, save the GSD file to disk: you may use any filename you wish. You may then import it into your PROFIBUS-DP network configuration tool and use it in an application program. It is possible to save several different GSD files for the same basic instrument, thereby setting up a library for different applications.

Once the configuration file has been downloaded, the network can be set running. If all is well the 'H' beacon on the controller will start to flash indicating that the data exchange is proceeding. Input data will then be transferred from the controller to the master, and output data will be transferred from the master to the controller.

If all 3500 controllers are of the same type only one GSD file need be configured.

**14.5.6 Demand Data**

The GSD file provides a convenient way to transfer input and output data between the controller and the master PLC or Supervisory Computer. It can, however, be wasteful in comms bandwidth if, for example:

1. It is used to read or write to occasionally accessed data, such as autotune or a three term value
2. Complex read/write sequences are performed which require a lot of data exchange, such as setting up and running a programmer.

For these parameters use the 'Demand Data' sub-protocol. This allows read/write access to any parameter within the controller using, 'Tags' which identify the parameters. Each parameter has a unique 16 bit tag. Parameter tags are the same as the modbus addresses, a list of which is given Chapter 30 MODBUS SCADA TABLE. The tags are also shown in the GSD File Editor and also in iTools.

When Demand Data is used, the first four (16 bit) registers of the PROFIBUS-DP Output data are reserved to encode a '**request message**' using the protocol. The control program is responsible for writing values into the first four registers to make requests. The instrument uses the first four registers of PROFIBUS-DP input data as a '**response message**' to return values and indicate success or failure of the operation that was requested.

Demand Data is enabled by the PROFIBUS-DP master setting the first byte of the module configuration data to 73 hex. This is done automatically, when the check box 'Use Demand Data' in the Profibus GSD Editor program is selected.

Demand Data is supported by standard software in many PLCs and can be implemented as part of the PLC program.

Demand Data uses the first 8 bytes in both the request and response message of the cyclic Data Exchange.



**14.5.6.1 Demand Data Structure**

Read Request (from Master)	
PLC Output Register Number	Output Data
The first four registers are reserved for demand data. The control program is responsible for writing values into these first four registers to make requests.	
1	Command Code and Parameter Tag
2	Extended Parameter Tag
3	Reserved
4	Anything
The registers that follow are used for the fixed output data defined by the GSD file	
5	Value or State
6	Value or State
7	Value or State
etc.	Value or State

Response from Slave to a Read Request (from Master)	
PLC Input Register Number	Input Data
The first four registers are reserved for responses to demand data.	
1	Command Code and Parameter Tag
2	Extended Parameter Tag
3	Reserved
4	Returned value
The registers that follow are used for the fixed input data defined by the GSD file	
5	Value or State
6	Value or State
7	Value or State
etc.	Value or State

Write Request (from PLC)	
PLC Output Register Number	Output Data
The first four registers are reserved for demand data. The control program is responsible for writing values into these first four registers to make requests.	
1	Command Code and Parameter Tag
2	Extended Parameter Tag
3	Reserved
4	Value or State to be written
The registers that follow are used for the fixed output data defined by the GSD file	
5	Value or State
6	Value or State
7	Value or State
etc.	Value or State

Response to Write Request (from Controller)	
PLC Output Register Number	Output Data
The first four registers are reserved for responses to demand data.	
1	Command Code and Parameter Tag
2	Extended Parameter Tag
3	Reserved
4	Write error code
The registers that follow are used for the fixed output data defined by the GSD file	
5	Value or State
6	Value or State
7	Value or State
etc.	Value or State

The Command code and Tag are encoded into Register 1 as follows:

Bits 15-12	Bit 11	Bit 10 - 0
Command Code	Reserved	Parameter Tag

Because only 11 bits are available for the Parameter Tag, the maximum tag allowable for standard demand data operations is 2048. The 3500 series controller allows tag values greater than this, therefore, extended tags have been provided using register 2. This is particularly important if ramp/dwell programs or configuration information is to be transferred over PROFIBUS-DP.

Fields in a request (output registers) should be set as follows: **NB: Eurotherm Extensions are printed in bold italic text**

Command (Hex)	Request (Master to Slave)	Parameter Tag	Extended Parameter Tag	Value
<u>0</u> 000	No Command	-	-	-
<u>1</u> 000	Read Request	Tag to Read	-	-
<u>2</u> 000	Write Request	Tag to Write	-	Value to write
<u>3</u> 000	<b><i>Extended Read Request</i></b>	<b><i>Must be Zero</i></b>	<b><i>Tag to Read</i></b>	-
<u>4</u> 000	<b><i>Extended Write Request</i></b>	<b><i>Must be Zero</i></b>	<b><i>Tag to Write</i></b>	<b><i>Value to Write</i></b>

Valid responses to a given command are as follows:

Command Field in request (output register)	Command Field in response (input register)	Meaning	Returned Value (input register 4)
<u>0</u> 000	<u>0</u> 000	Acknowledge No Command	-
<u>1</u> 000	<u>1</u> 000	Tag Read Successfully	Value Read
1000	<u>7</u> 000	Tag Read Not Successful	Error Code (see below)
<u>2</u> 000	<u>1</u> 000	Tag Written Successfully	-
<u>2</u> 000	<u>7</u> 000	Tag Write Not Successful	Write Request
<u>3</u> 000	<u>1</u> 000	<b><i>Extended Tag Read Successfully</i></b>	<b><i>Value Read</i></b>
<u>3</u> 000	<u>7</u> 000	<b><i>Extended Tag Read Not Successful</i></b>	<b><i>Error Code (see below)</i></b>
<u>4</u> 000	<u>1</u> 000	<b><i>Extended Tag Written Successfully</i></b>	-
<u>4</u> 000	<u>7</u> 000	<b><i>Extended Tag Write Not Successful</i></b>	<b><i>Error Code (see below)</i></b>

The command field in the response message either

- Confirms that no operation has been requested
- Indicates that a Read or Write request has been completed successfully
- Indicates that a Read or Write has failed.

Error Codes in input register 4 are as follows.

Error Code	Meaning
0	Invalid Tag Number
1	Read Only Parameter
2	Value out of range

Because the First Word of the Output data is used to contain several different fields, it is important to understand how the various components are distributed within the 16 bits which make up the word.

The tables which follow show how the bits are divided between the three components. The least significant bit is numbered 0 and the highest significant bit is numbered 15.

**Output Data (Command)**

The data encoded in these registers is to **Request** a message.

**Request: Word 1**

Word 1 is a bit field containing a command code and a parameter tag (if it is less than 16383). It is constructed as shown below:

Bit No.	15	14	13	12	11	10	9	8	7	6	5	4	3	2	1	0
Decimal	32768	16384	8192	4096	2048	1024	512	256	128	64	32	16	8	4	2	1
Hex	8000	4000	2000	1000	800	400	200	100	80	40	20	10	8	4	2	1
Function	Command code				Reserved	Parameter Tag (Address)										
No command	Set all these bits to 0 when Demand Data needs no action															
Read request	0	0	0	1	Must be 0	Set these bits to the address of the target parameter only if the address is less than 2048 (dec). Otherwise set all these bits to 0 and use the SECOND word to define the address.										
Write request	0	0	1	0	Must be 0											
Read of extended address	0	0	1	1	Must be 0											
Write of extended address	0	1	0	0	Must be 0											



**Note:** Reading and writing can be done successively, in any order, but if no further action is needed for a time, then it is desirable to set the command code to 0. This will prevent continuous writing to the slave. As an example of why this is undesirable, continuous writing of a setpoint will prevent local control of the setpoint using the control panel of the slave.

**Request: Word 2**

The 11 bits available for the parameter tag only allow tag numbers up to 2047 to be coded into Word 1. For tag numbers higher than this, the Extended Read and Extended Write commands are coded into the high nibble of Word 1 and the parameter tag is put into Word 2. This allows tags up to 65535.

Bit No.	15	14	13	12	11	10	9	8	7	6	5	4	3	2	1	0
Decimal	32768	16384	8192	4096	2048	1024	512	256	128	64	32	16	8	4	2	1
Hex	8000	4000	2000	1000	800	400	200	100	80	40	20	10	8	4	2	1
Function	Command code				Reserved	Parameter Tag (Address)										
Always	Set all these bits to 0 if the target parameter address is less than 2048 (Decimal) 800 (HEX). Otherwise set bits 0 to 15 to match the parameter address.															

**Request: Word 3**

Word 3 is reserved and not used.

Bit No.	15	14	13	12	11	10	9	8	7	6	5	4	3	2	1	0
Decimal	32768	16384	8192	4096	2048	1024	512	256	128	64	32	16	8	4	2	1
Hex	8000	4000	2000	1000	800	400	200	100	80	40	20	10	8	4	2	1
Function	Command code				Reserved	Parameter Tag (Address)										
Always	Reserved. All of these bits must be set to 0.															

**Request: Word 4**

Word 4 contains the parameter value if the command is a write, otherwise it is unimportant. The parameter value is, therefore, always a 16 bit word.

Bit No.	15	14	13	12	11	10	9	8	7	6	5	4	3	2	1	0
Decimal	32768	16384	8192	4096	2048	1024	512	256	128	64	32	16	8	4	2	1
Hex	8000	4000	2000	1000	800	400	200	100	80	40	20	10	8	4	2	1
Function	Command code				Reserved	Parameter Tag (Address)										
Dependent on request	Set all these bits to 0 for a read request and to the value to be written for a write request															



**Input Data (Response)**

The data encoded in these registers is to **Respond** to a message.

**Request Response: Word 1**

Word 1 is a bit field containing the response code and the parameter tag (if it is less than 16383). It is constructed as follows:

Bit No.	15	14	13	12	11	10	9	8	7	6	5	4	3	2	1	0
Decimal	32768	16384	8192	4096	2048	1024	512	256	128	64	32	16	8	4	2	1
Function	Response code				Reserved	Parameter Tag (Address)										
No command	Acknowledge null command. All of these bits should be 0 following a 'No Command' request.															
Successful read or write request	0	0	0	1	Should be 0	Should contain the parameter tag										
Unsuccessful read or write request	0	1	1	1	Should be 0											

**Request Response: Word 2**

Echoes the extended parameter tag if it was included in the command

Bit No.	15	14	13	12	11	10	9	8	7	6	5	4	3	2	1	0
Decimal	32768	16384	8192	4096	2048	1024	512	256	128	64	32	16	8	4	2	1
Always	These bits will all be 0 if extended addressing has not been required because the address is less than 2048. If the address required extended addressing then these bits will contain the parameter address.															

**Request Response: Word 3**

Word 3 is reserved and not used.

Bit No.	15	14	13	12	11	10	9	8	7	6	5	4	3	2	1	0
Decimal	32768	16384	8192	4096	2048	1024	512	256	128	64	32	16	8	4	2	1
Always	Reserved. All of these bits must be set to 0.															

**Request Response: Word 4**

Word 4 contains the parameter value if the command was a successful Read. It echoes the command data if the command was a successful Write, and it contains an error code if the command was unsuccessful.

Bit No.	15	14	13	12	11	10	9	8	7	6	5	4	3	2	1	0
Decimal	32768	16384	8192	4096	2048	1024	512	256	128	64	32	16	8	4	2	1
Dependent on request	These bits contain the read value following a read request and an error code following a write															

**Error codes**

The command field in the response message either

- Confirms that no operation has been requested
- Indicates that a Read or Write request has been completed successfully
- Indicates that a Read or Write has failed

Error codes for 3500 instruments in Input Register 4 are:

Error code	
0	Invalid parameter tag
1	Read only parameter
2	Value out of range

**Worked Example 1 - Read Loop 1 Process Value from 3500 Controller**

The general sequence of operation is as follows:

Step	Transaction	Description
1	Write a null command to the slave	To clear down any previous transaction. This should be done at the start of any sequence of operations using demand data in order to ensure that the system is properly initialised.
2	Wait for a null response from the slave	To detect the response to a real command
3	Write a command to the output data which will trigger a write to the slave	Combine parameter tag and write command into Word 1
4	Wait for the Slave response	The slave must process the command and respond
5	Read the returned data	From Word 4

**Step 1.** Write a null command to clear any previous transaction.

Bit No.	15	14	13	12	11	10	9	8	7	6	5	4	3	2	1	0
Decimal	32768	16384	8192	4096	2048	1024	512	256	128	64	32	16	8	4	2	1
Function	Command code				Reserved	Parameter Tag (Address)										
Read request	0	0	0	0	0	0	0	0	0	0	0	0	0	0	0	0

**Step 2.** Wait for the response

Bit No.	15	14	13	12	11	10	9	8	7	6	5	4	3	2	1	0
Decimal	32768	16384	8192	4096	2048	1024	512	256	128	64	32	16	8	4	2	1
Function	Command code				Reserved	Parameter Tag (Address)										
Read request	0	0	0	0	0	0	0	0	0	0	0	0	0	0	0	0

**Step 3.** Write a command to Loop 1 PV at tag address 1. This address is less than 2048 so Extended addressing is not required for this particular example.

The command code for a standard read puts a 1 into bit 12 of Word 1.

1 puts 0000 0001 in the lower 11 bits of Word 1.

Bit No.	15	14	13	12	11	10	9	8	7	6	5	4	3	2	1	0
Decimal	32768	16384	8192	4096	2048	1024	512	256	128	64	32	16	8	4	2	1
Function	Command code				Reserved	Parameter Tag (Address)										
Read request	0	0	0	1	Must be 0	0	0	0	0	0	0	0	0	0	0	1

The value to be written to the First Output Word will, therefore, be  $4096+1 = 4397$  (dec). AC40+1 = Ac41 (hex).

The values for the other three Output Words should be set to 0 as this is a write.

**Responses**

**Step 4.** Wait for a response.

First Input Word – the parameter address.

Bit No.	15	14	13	12	11	10	9	8	7	6	5	4	3	2	1	0
Decimal	32768	16384	8192	4096	2048	1024	512	256	128	64	32	16	8	4	2	1
Response	Command code				Reserved	Parameter Tag (Address)										
Read request	0	0	0	1	0	0	0	0	0	0	0	0	0	0	0	1
Meaning	1 = read parameter				0	Parameter address 1										

**Step 5.** Return the Value

Fourth Input Word – the parameter value

Bit No.	15	14	13	12	11	10	9	8	7	6	5	4	3	2	1	0
Decimal	32768	16384	8192	4096	2048	1024	512	256	128	64	32	16	8	4	2	1
Response	0	0	0	0	0	0	0	0	0	0	0	1	1	1	1	0
Meaning	Parameter value is $16+8+4+2 = 30$ (dec), $10+8+2 = 1E$ (hex)															

**Worked example 2 - Starting an Autotune**

Enable Loop 1 Autotune.

**Step 1:** Clear any previous demand data requests. This is the same command as in the previous example.

**Step 2:** Wait until the following response message is received. This is the same command as in the previous example.

**Step 3:** Write 1 to Loop 1 Autotune Enable at tag address 270 (dec).

Bit No.	15	14	13	12	11	10	9	8	7	6	5	4	3	2	1	0
Decimal	32768	16384	8192	4096	2048	1024	512	256	128	64	32	16	8	4	2	1
Function	Command code				Reserved	Parameter Tag (Address)										
Read request	0	0	1	0	0	0	0	1	0	0	0	0	1	1	1	0

Write request 8192 (dec) + tag address 270 (dec) = 8462 (dec), 2000 + 10E = 210E (hex).

**Step 4:** Wait for response

Bit No.	15	14	13	12	11	10	9	8	7	6	5	4	3	2	1	0
Decimal	32768	16384	8192	4096	2048	1024	512	256	128	64	32	16	8	4	2	1
Function	Command code				Reserved	Parameter Tag (Address)										
Read request	0	0	0	1	0	0	0	1	0	0	0	0	1	1	1	0

Successful write code 4096 (dec) + tag address 270 (dec) = 4366 (dec), 1000 + 10E = 110E (hex)

**Response**

**Step 5a:** If the Autotune write was successful, poll Stage of Tune (tag 269) until Autotune complete.

Bit No.	15	14	13	12	11	10	9	8	7	6	5	4	3	2	1	0
Decimal	32768	16384	8192	4096	2048	1024	512	256	128	64	32	16	8	4	2	1
Function	Command code				Reserved	Parameter Tag (Address)										
Read request	0	0	0	1	0	0	0	1	0	0	0	0	1	1	0	1

Successful write code 4096 (dec) + tag address 269 (dec) = 4365 (dec), 1000 + 10D = 110D (Hex)

**Step 6: To determine when Autotune is complete:**

Look at the enumeration of the Stage of Tune parameter at address 269 until the enumeration changes to 12 (Complete). Any value for register 1 other than 4108 signifies an error has occurred, in which case register 4 will contain an error code of 0 or 1 or 2.

Bit No.	15	14	13	12	11	10	9	8	7	6	5	4	3	2	1	0
Decimal	32768	16384	8192	4096	2048	1024	512	256	128	64	32	16	8	4	2	1
Response	0	0	0	1	0	0	0	0	0	0	0	1	1	0	0	0
Meaning	Parameter value is 8+4= 12															

**Step 5b:** If an error occurs after Step 4 (Code 7), Step 5a becomes:

Bit No.	15	14	13	12	11	10	9	8	7	6	5	4	3	2	1	0
Decimal	32768	16384	8192	4096	2048	1024	512	256	128	64	32	16	8	4	2	1
Function	Command code				Reserved	Parameter Tag (Address)										
Read request	0	1	1	1	0	0	0	1	0	0	0	0	1	1	1	0

Error 28672 (dec) + tag address 270 (dec) = 28942 (dec), 7000 + 10E = 710E (hex)

**Worked example 3 - Uploading Program Data**

3500 series controllers may be configured as ramp/dwell programmers (see Chapter 22). It is often the case that specific ramp dwell sequences need to be downloaded to an instrument as saved 'recipes'. Because of the amount of data involved, it would be impossible if only standard Profibus-DP input and output frames were to be used. Use of the demand data protocol is the only way this operation may be performed.

An example of a simple program is shown below where Segment 1 ramps the temperature up to a target value and Segment 2 holds it there for a period of time.

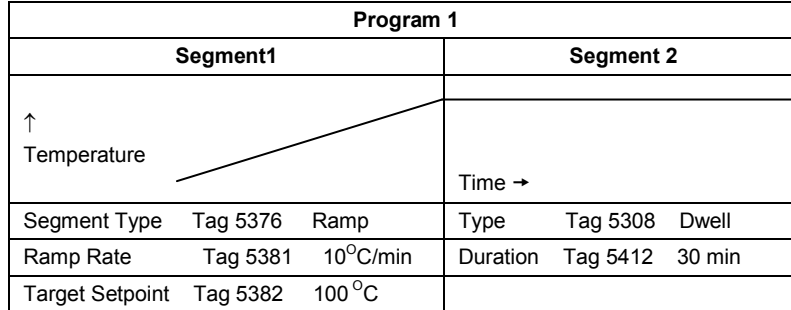

**Step 1 and Step 2:** Clear any previous demand data requests. See previous examples

**Step 3:** Write to Segment 1 of Program 1. The first parameter is the Segment Type at tag address 5376 (1500 hex).

The command code for an extended write address is 4000.

The extended write tag is 4000 (hex) + parameter address 1500 (hex) = 5500 (hex) and puts 0101 0101 0000 0000 into Word 1.

**Word 1** is an extended write request:

Bit No.	15	14	13	12	11	10	9	8	7	6	5	4	3	2	1	0
Decimal	32768	16384	8192	4096	2048	1024	512	256	128	64	32	16	8	4	2	1
Function	Command code				Reserved	Parameter Tag (Address)										
Read request	0	1	0	1	0	1	0	1	0	0	0	0	0	0	0	0

**Word 2** is the parameter value. For Type = Ramp the enumeration is 1:

Bit No.	15	14	13	12	11	10	9	8	7	6	5	4	3	2	1	0
Decimal	32768	16384	8192	4096	2048	1024	512	256	128	64	32	16	8	4	2	1
Function					Reserved	Parameter Value										
Read request	0	0	0	0	0	0	0	0	0	0	0	0	0	0	0	1

Parameter value 1 puts 0000 0000 0000 0001 into Word 2.

**Response:** Wait for one of the following responses to be received.

**a. Assuming that the write request has been successful:**

The command code for an extended read request is 3000 (hex).

The parameter address is 1500 (hex), so the response is 3000 + 1500 = 4500 (hex)

Bit No.	15	14	13	12	11	10	9	8	7	6	5	4	3	2	1	0
Decimal	32768	16384	8192	4096	2048	1024	512	256	128	64	32	16	8	4	2	1
Hex	8000	4000	2000	1000	800	400	200	100	80	40	20	10	8	4	2	1
Function	Command code				Reserved	Parameter Tag (Address)										
Read request	0	1	0	0	0	1	0	1	0	0	0	0	0	0	0	0

**b. If the write request was unsuccessful the error response is:**

Error code 7000 (hex) + parameter address 1500 (hex) = 8500 (hex)

Bit No.	15	14	13	12	11	10	9	8	7	6	5	4	3	2	1	0
Decimal	32768	16384	8192	4096	2048	1024	512	256	128	64	32	16	8	4	2	1
Hex	8000	4000	2000	1000	800	400	200	100	80	40	20	10	8	4	2	1
Function	Command code				Reserved	Parameter Tag (Address)										
Read request	1	0	0	0	0	1	0	1	0	0	0	0	0	0	0	0

Generally it is only required to write to this parameter once, therefore, send the clear command as shown in the previous examples, then repeat the above for the remaining parameters starting with ramp rate at tag address 5381 as shown in the diagram above.

## 14.6 DeviceNet Protocol

DeviceNet has been designed as a low level network for communication between Programmable Logic Controllers (PLCs) and devices such as switches and IO devices. Each device and/or controller is a node on the network. 3500 series controllers can be included in a DeviceNet installation using the DeviceNet interface module plugged into communications slot H. For further information regarding configuration of 3500 series controllers for a DeviceNet network, refer to the DeviceNet Communications Handbook HA027506 which may be downloaded from [www.eurotherm.com](http://www.eurotherm.com).

It is not within the scope of this manual to describe the DeviceNet standard and for this you should refer to the DeviceNet specification which may be found at [www.odva.org](http://www.odva.org).

### 14.6.1 Devicenet Parameters

If 'Protocol' is set 'Devicenet' the following parameters are available.

List Header - Comms		Sub-header: H only			
Name ⌚ to select	Parameter Description	Value Press ⏴ or ⏵ to change values		Default	Access Level
Ident	Identifies that the comms module is fitted	None Comms	No module fitted Communications module fitted		R/O
Protocol	Digital communications protocol	Devicenet			Conf R/O in L3
Baud Rate	Communications baud rate	125K 250K 500K		125K	Conf R/O in L3
Status	Comms network status	Running	Network connected and operational		R/O
		Init	Network initialising		
		Ready	Network ready to accept connection		
		Offline	Network offline		
Address	Instrument address	0 to 63		1	L3
Wdog Flag	See section 14.3 for an explanation.	On/Off		Off	R/O
Wdog Action		ManRec/AutoRec		ManRec	Conf R/O in L3
Wdog Timeout		0.0 to 60.0 seconds		0.0	
WdogRecy		0.0 to Wdog Timeout		0.0	

### 14.7 Comms Indirection Table

3500 series controllers make a fixed set of parameters available over digital communications using Modbus addresses. This is known as the SCADA Table. The SCADA Modbus address area is 0 to 16111 (3EEFH). There are three addresses reserved to allow iTools to detect the instrument: 107, 121 and 122 - these cannot be set as a Destination value.

The following Modbus addresses have been reserved for use via the Comms Indirection Table. By default the addresses have no associated parameters:

Modbus Range (Decimal)	Modbus Range (Hex)
15360 to 15615	3C00 to 3CFF

The programmer area (2000h - 27BFh) within the SCADA table is not supported.

When accessed here, the parameter may be presented as scaled integer, minutes or Native format and may be flagged as read-only.

The Comms Table is used to make additional parameters which are not in the SCADA table available for specific applications. It is recommended that iTools is used to set up the required table as shown in section 30.

The following parameters are available in the Comms Table:-

List Header - Commstab		Sub-headers: 1 to 250		
Name Ⓞ to select	Parameter Description	Value Press ⏴ or ⏵ to change values	Default	Access Level
Dest	Modbus destination	The Modbus address where the selected parameter will appear in the SCADA table area. Range is 0 to 16111. A value of -1 indicates not used.	Not Used	Conf
Source	Source parameter	The parameter that will be mapped into the Destination Modbus address. It should be noted that setting this parameter via iTools will allow sources that are unavailable to the HMI. If such a setting is subsequently examined using the front panel it cannot be edited, only deleted.		Conf
Native	Native data format	The data format in which the source parameter will be presented at the destination address.  0 Integer - causes a scaled integer representation of the value to appear at the modbus address. 1 Native - causes the native format of the value to appear at the modbus address. It should be noted that if a 32 bit value is returned, it will use two adjacent 16 bit modbus addresses.	Integer	Conf
ReadOnly	Read only Read/write only if source is R/W	This parameter may be used to override the normal alterability rule for the parameter and force it to be Read Only. Setting this value to 'ReadWrite' enables the normal alterability rule(s).  0 ReadWrite - Allow the value's normal alterability rule to be applied at the selected Modbus address 1 Read-Only- Overrides the parameter's normal alterability rule to present it as read only at the selected Modbus address		Conf
Minutes	Time parameter resolution.	This allows for Time parameters to be presented in alternate resolutions, for example 1/10th of minutes or 1/10th of seconds.  0 Seconds- the Time parameter will be presented as sss.s 1 Minutes - the Time parameter will be presented as mmm.m	Seconds	Conf

## 14.8 Broadcast Communications

Broadcast communications allows 3500 series controllers to send a single value from a master to a number of slave instruments using the broadcast address 0 with Modbus broadcast function code 6 (Write single value). This allows the 3500 to link through digital communications with other products without the need for a supervisory PC to create a small system solution.

Example applications include multi-zone profiling applications or cascade control using a second controller. The facility provides a simple and precise alternative to analogue retransmission.



**Warning:** When using broadcast communications, bear in mind that updated values are sent many times a second. Before using this facility, check that the instrument to which you wish to send values can accept continuous writes. ***It should be noted that in common with many third party lower cost units, the Eurotherm 2200 series and the 3200 series prior to version V1.10 do not accept continuous writes to the temperature setpoint. Damage to the internal non-volatile memory could result from the use of this function. If in any doubt, contact the manufacturer of the device in question for advice.***

When using the 3200 series fitted with software version 1.10 and greater, use the Remote Setpoint variable at Modbus address 26 if you need to write to a temperature setpoint. This has no write restrictions and may also have a local trim value applied. There is no restriction on writing to the 2400 or 3500 series.

### 14.8.1 3500 Broadcast Master

The 3500 broadcast master can be connected to up to 31 slaves if no segment repeaters are used. If repeaters are used to provide additional segments, 32 slaves are permitted in each new segment. The master is configured by selecting a Modbus register address to which a value is to be sent. The value to send is selected by wiring it to the Broadcast Value. Once the function has been enabled, the instrument will send this value out over the communications link every control cycle (110ms).



**Note:** The parameter being broadcast must be set to the same decimal point resolution in both master and slave instruments.



**Note:** iTools, or any other Modbus master, may be connected to the same port on which the broadcast master is enabled. In this case the broadcast is temporarily inhibited. It will restart approximately 30 seconds after iTools is removed. This is to allow reconfiguration of the instrument using iTools even when broadcast communications is operating.

A typical example might be a multi zone oven where the setpoint of each zone is required to follow, with digital accuracy, the setpoint of a master controller.

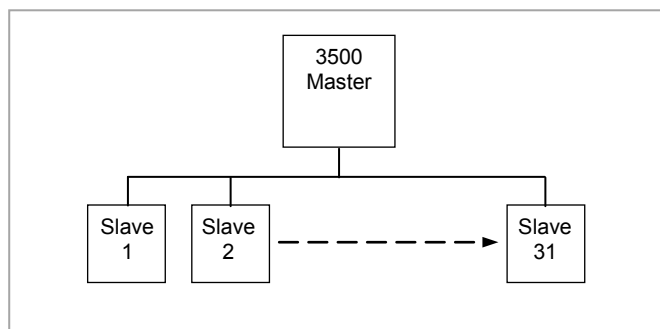



Figure -1: Broadcast Comms

**14.8.2 Wiring Connections - Broadcast Communications**

The Digital Communications module for the master can be fitted in either Communications Module slot H or J and uses terminals HA to HF or JA to JF respectively.  
 The Digital Communications module for the slave is fitted in either slot J or slot H.  
 The wiring connections and the precautions shown in section 1.8 apply.



**Caution: EIA422, EIA485 4-wire or EIA232**  
**Rx connections in the master are wired to Tx connections of the slave**  
**Tx connections in the master are wired to Rx connections of the slave**

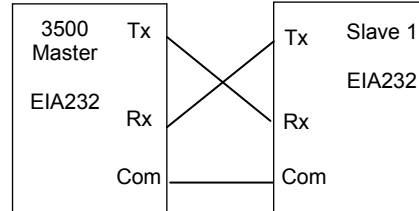
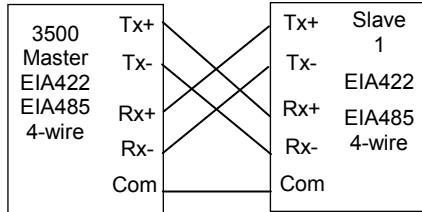

Terminal Function	Terminal number
Tx+ (TxA)	HE or JE
Tx- (TxB)	HF or JF
Rx+ (RxA)	HB or JB
Rx- (RxB)	HC or JC
Common	HD or JD

Terminal Function	Terminal number
Tx	HE or JE
Rx	HF or JF
Common	HD or JD

Figure -2: Rx/Tx Connections for EIA422, EIA485 5-wire, EIA232



**Caution: EIA485 2-wire**  
**Connect A (+) in the master to A (+) of the slave**  
**Connect B (-) in the master to B (-) of the slave**

This is shown diagrammatically below

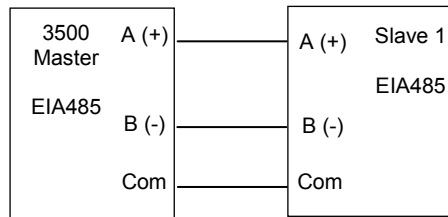

Terminal Function	Terminal number
B (-) (Tx)	HE or JE
A (+) (Rx)	HF or JF
Common	HD or JD

Figure -3: Rx/Tx Connections EIA484 3-wire

**14.8.3 Example: To Send SP from the Master to SP in a Slave**

Wire the **setpoint** in the master to '**Bcast Val**'. The procedure for this is shown in section 5.1 or using iTools section 27.10.

Set '**Dest Addr**' in the master to '2'. 2 is the modbus value for '**Target SP**' \*. The value of the master setpoint will be shown in the lower display on the slave (assuming the slave has been configured for SP in the lower display).

- See Appendix A for the full address list.



### 14.9 Modbus Master Communications

The Modbus Master function block has been added from firmware versions 2.90 on controllers supplied after March 2010. It extends the Broadcast Communications feature, described in the previous section, by allowing Modbus master communications to be generated from the instrument. The standard instrument contains one Modbus Master function block but up to twelve blocks are orderable. Each block can access up to sixteen consecutive parameters which may be read or written to slaves.

The function block can be configured on either the H or J communications slots but each needs to be set up separately for Master Communications. Note that, unlike Broadcast Communications described in the previous section, the Modbus Master function block does NOT allow concurrent use of the communications port with iTools.

The data items are held in the function block as float values and are converted to the 16 bit Modbus register value by means of multiplier and offset parameters. There is also the ability to select signed (a whole number between -32768 and 32767) or unsigned (a whole number between 0 and 65535) representation in the Modbus register data.

When enabled, Master Communications will run in levels 1, 2 and 3 but not in Configuration level.

#### 14.9.1 Wiring connections

A 3500 Modbus master can be connected to up to 12 slaves. This limit is applied by the number of Master Comms function blocks available in the 3500 master.

Any Modbus Master block, however, can be configured to broadcast write its parameters. The number of slaves then supported is only limited by signalling considerations as in section 14.8.1.

**X Warning:** The warning shown in section 14.8 applies

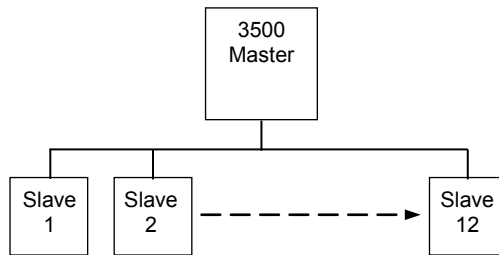

Wiring connections for Modbus Master Communications is the same as shown in the previous section (14.8.2) and may use EIA232, EIA485 3-Wire or EIA422 5-Wire.



#### 14.9.2 Modbus Master Parameters



If 'Protocol' is set 'MBUS\_M' the following parameters are available under the 'Comms' list header.



List Header - Comms		Sub-header: H only				
Name	Parameter Description	Value and Description		Default	Access Level	
Press  to select parameters		Press  or  to change values				
Ident	Identifies that the comms module is fitted	None Comms	No module fitted Communications module fitted		R/O in L3 and conf.	
Protocol	Digital communications protocol	MBUS_M			R/W in conf. R/O in L3	
Baud Rate	Communications baud rate	4800; 9600; 19,200		19200		
Parity	Communications parity	None; Even; Odd		None		
Address	Instrument address	0 to 254		1	R/W in L3 and Conf.	
Timeout	Master Comms Timeout. The time that the master comms will allow for the slave to respond. This parameter is only shown when Protocol = MBUS_M.	Settable between 200mS to 5 seconds		0:00.2	R/W in L3 and Conf.	

R/W = Read and Write  
R/O = Read only

All subsequent parameters are within the Master Comms Function Block - list header 'Mstrcomms'.  
Up to 12 Master Comms blocks can be configured.

List Header - Mstrcomms		Sub-header: 1 to 12			
Name	Parameter Description	Value and Description		Default	Access Level
Press  to select parameters		Press  or  to change values			
Mode	Block mode. Sets the transmission mode of the block. Alterable only if the block is not running ('Enable' = 'No')	Cont	Continuous. Master Comms transactions will be continuous after the Block Enable parameter rising edge, while the value remains true.	Cont	R/W in Conf. R/O in L3
		OneShot	One shot. One Master Comms transaction will be triggered for each rising edge seen on the Block Enable parameter. Retries on failure will be attempted as normal. This might be used for example to trigger a transaction from a wired event.		
		Demand	Demand write. This is the same as OneShot but also triggers a one shot transaction when any of the SlvData values change. Following a power cycle a transaction will not take place until a change is seen in the slave data.		
Enable	To run the Master Comms Block	Yes	Each rising edge seen on this parameter will start Master Comms transactions according to the setting of the Mode parameter and reset diagnostic parameter counts.	No	R/W in L3 and Conf.
		No	The block will not generate any Master Comms traffic. If the parameter values and addresses are dynamic it is necessary to set the Enable to No when setting up master comms parameters.		
Port	Master Comms Port Select The selected port will need to be set up as a Modbus Master in the 'Comms' list - set 'Protocol' = MBUS_M.	H	The master transactions use the instrument H port		R/W in conf. R/O in L3 R/O when 'Enable' = 'Yes'.
		J	The master transactions use the instrument J port		
Suspend Count	Failure Count Before Suspend The number of consecutive errors before a Node is assumed to have failed.	0 to 250	A value of 0 means that master comms is never suspended by consecutive failures.	0	R/W in conf. R/O in L3
Suspend Exceed	Suspend count exceeded. This parameter is only shown when 'Suspend Count' ≠ 0	Yes No	If the number of consecutive message failures exceeds the SuspendCount value, this status will be set to 'Yes' and the Block will stop running.		R/O
Susp Retry	Suspend retry interval. This parameter is only shown when 'Suspend Count' ≠ 0	h:m:s:ms	Time period before automatically attempting to restart master comms to a suspended node. A value of 0 means that no automatic retry will be attempted.		R/W in Conf. R/O in L3
Node	Slave instrument node address	0 to 255	A value of 0 will cause a broadcast message to be generated and limit the function code to Write (Function codes 5, 6, 15, 16)	1	R/W in conf. R/O in L3

List Header - Mstrcomms		Sub-header: 1 to 12			
Name	Parameter Description	Value and Description		Default	Access Level
Press  to select parameters		Press  or  to change values			
Function	Modbus function code as defined by the Modbus standard.	Func01	Read coil status. Read up to 16 bits from the slave The SlvData1 parameter will contain the value received from the slave.		R/W in conf. R/O in L3
		Func02	Read input status. Read up to 16 bits from the slave The SlvData1 parameter will contain the value received from the slave.		
		Func03	Read holding register. Read up to 16 words from the slave The SlvData1 to 16 parameters will contain the values received from the slave.		
		Func04	Read input register. Read up to 16 words from the slave The SlvData1 to 16 parameters will contain the values received from the slave.		
		Func05	Force coil Write a single bit. The value in SlvData1 will be written to the slave.		
		Func06	Load register Write a single word. The value in SlvData1 will be written to the slave.		
		Func15	Force multiple coils Write up to 16 bits. The value in SlvData1 will be written to the slave.		
		Func16	Load multiple registers The values in SlvData1 to 16 will be written to the slave.		
Address	Slave instrument parameter address	0 to 65535	A value of 0 is allowed for compatibility with JBUS slaves.	1	R/W in L3 and conf. if 'Enable' = No
Count	Item count.	1 to 16	For function codes 1, 2, and 15, up to 16 bits may be read or written into SlvData1. For function codes 3, 4, and 16, up to 16 words may be read or written into SlvData1 to 16 as appropriate.	1	R/W in conf. R/O in L3
SlvData1 to SlvData16	Data to/from the slave. When set to read the slave, this parameter will contain the data received. When set to write to the slave, this parameter will contain the data to be written. For bit based function codes 1, 2, 5 and 15 all data is transferred through SlvData1.	Full float range	SlvData1 is always available. SlvData2-16 are not available for bit functions. Otherwise available according to item count.	0	R/W in L3 if Write Functions 5, 6, 15, 16.  R/O for Read Functions 1, 2, 3, 4.
Format	Data format The 16 bit data to/from the slave is interpreted as signed or unsigned according to the setting of this parameter. This parameter is not available for bit functions where all values are treated as Unsigned.	Sign	The slave data is treated as a 16 bit signed integer. When writing to the slave the value is clipped to the limits -32768 to +32767.		R/W in conf. R/O in L3
		Unsign	The slave data is treated as a 16 bit unsigned integer. When writing to the slave the value is clipped to the limits 0 to 65535.		

List Header - Mstrcomms		Sub-header: 1 to 12				
Name	Parameter Description	Value and Description		Default	Access Level	
Press  to select parameters		Press  or  to change values				
Factor	Data factor Data Factor and Offset parameter below, have a different effect, depending upon the Function code being used: <b>Read</b> The value read from the slave is first <i>divided</i> by the value of the Data Factor, then the Data Offset is added before being placed in the SlvDataN float parameter. <b>Write</b> The SlvDataN float value first has the Data Offset added, then the result is <i>multiplied</i> by the Data Factor before being sent to the slave.	Full float range		1.00	R/W in L3 and conf. These parameters are not available for bit functions - the Pack and Unpack Function Blocks may be used here.	
Offset	Data offset See also Data Factor above.	Full float range		0.00		
Exception Code	Last Modbus exception code	0 to 255	This value is reset to 0 by the rising edge of the Block Enable parameter		R/O in L3 and conf.	
Transact Count	Total transaction count This is the count of all transactions started, whether the outcome is successful or not.		The value will be reset by the rising edge of the Block Enable parameter		R/O in L3 and conf.	
Success Count	Successful transaction count This is the count of successful transactions. Note that Modbus exception messages are counted as a successful transaction.		The value will be reset by the rising edge of the Block Enable parameter.		R/O in L3 and conf.	
Error Count	Message error count This is the count of message errors, it includes crc, syntax and timeout errors		The value will be reset by the rising edge of the Block Enable parameter		R/O in L3 and conf.	
Exception Count	Exception Count This is the count of Modbus exception messages.		The value will be reset by the rising edge of the Block Enable parameter		R/O in L3 and conf.	

R/W = Read and Write

R/O = Read only

### 14.9.3 Set Up Example



Applications may be set up from the front panel of the controller but it is recommended to use iTools configuration package. An example of how to set up an application is, therefore, given in the iTools section 27.20.

## 14.10 Packbit

Packbit consists of four blocks and were added at the same time as the Master Communications block from firmware versions 2.90.

Each block allows 16 individual bits to be packed into a 16 bit integer.

### 14.10.1 Packbit Parameters



List Header - packbit		Sub-header: 1, 2, 3, 4			
Name	Parameter Description	Value and Description		Default	Access Level
Press  to select parameters		Press  or  to change values			
In1 to In16	Input bit 1 to Input bit 16. All values less than 0.5 will be treated as FALSE; all other values will be treated as TRUE.	Full float range		0	R/W in L3 and conf.
Output	Output The inputs are mapped to corresponding bits within the Output such that In1 goes to bit0, In2 to bit1 - In16 goes to bit 15			0	R/O
Status	The block Status parameter reflects the status of the Output parameter: if any Input is BAD, this Status will be set according to the Fallback Type.	Good Bad			R/O
Fall Type	Fallback Type The Output status (and Status parameter) if one of the inputs is bad.	FallGood	If any Input status is BAD, set the Output status (and Status parameter) GOOD and set the Output value as set by the FallBack parameter.		R/O R/W in Conf.
		FallBad	If any Input status is BAD, set the Output status (and Status parameter) BAD and set the Output value as set by the FallBack parameter.		
Fallback	Fallback value The value applied to the Output parameter when any Input is BAD	0 to 65535		0	R/O

## 14.11 Unpackbit

Unpackbit consists of four blocks and were added at the same time as the Master Communications block from firmware versions 2.90.

Unpackbit is the opposite of packbit and allows a 16 bit integer to be unpacked into 16 individual bits.

### 14.11.1 Unpackbit Parameters

List Header - unpackbit		Sub-header: 1, 2, 3, 4			
Name	Parameter Description	Value and Description		Default	Access Level
Press  to select parameters		Press  or  to change values			
Input	Input. The Input bit positions are unpacked to the outputs as follows: Bit 0 to Out1, Bit1 to Out2...Bit 15 to Out16			0	R/O
Out1 to Out 16	Output 1 to Output 16	Off On		0	R/O
Status	Block Status parameter: if any Input is BAD, this Status will set according to the Fallback Type.	Good Bad			R/O
Fall Type	Fallback Type The Status value if the Input is BAD or out of range.	FallGood	If the Input status is BAD or the value is out of range, set the Status parameter GOOD and set the Output values as though the FallBack value was present on the Input.		R/O
		FallBad	If the Input status is BAD or the value is out of range, set the Status parameter BAD and set the Output values as though the FallBack value was present on the Input.		
Fallback	Fallback value If the Input is BAD or out of range, this value is applied to drive the Outputs as though it was present on the Input.			0	R/O

## 15. Chapter 15 Counters, Timers, Totalisers, Real Time Clock

A series of function blocks are available which are based on time/date information. These may be used as part of the control process.

### 15.1 Counters

Up to two counters are available. They provide a synchronous edge triggered event counter.

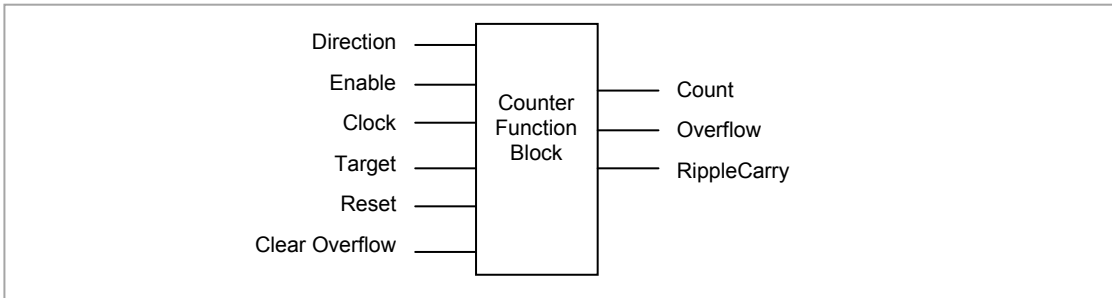
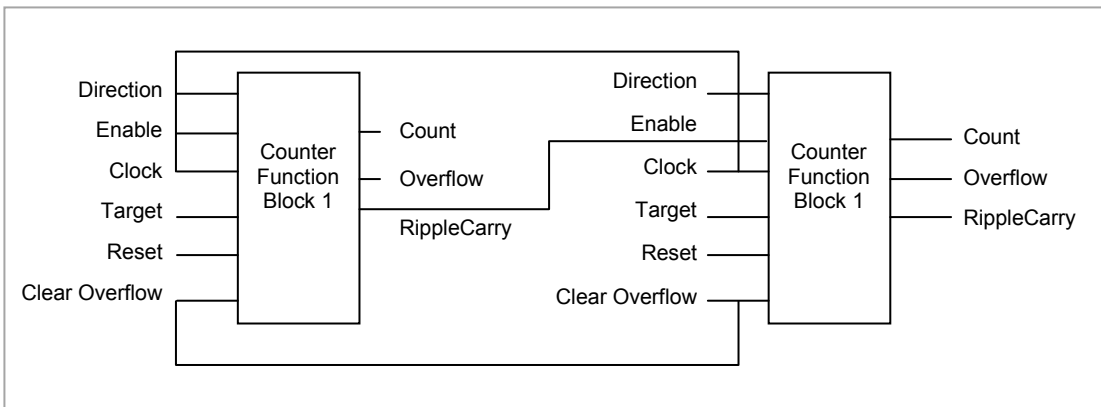

**Figure 15-1: Counter Function Block**

When configured as an Up counter, Clock events increment Count until reaching the Target. On reaching Target RippleCarry is set true. At the next clock pulse, Count returns to zero. Overflow is latched true and RippleCarry is returned false.

When configured as a down counter, Clock events decrement Count until it reaches zero. On reaching zero RippleCarry is set true. At the next clock pulse, Count returns to the Target count. Overflow is latched true and RippleCarry is reset false

Counter blocks can be cascaded as shown in the diagram below



**Figure 15-2: Cascading Counters**

The RippleCarry output of one counter acts as an enabling input for the next counter. In this respect the next counter in sequence can only detect a clock edge if it was enabled on the previous clock edge. This means that the Carry output from a counter must lead its Overflow output by one clock cycle. The Carry output is, therefore, called a RippleCarry as it is NOT generated on an Overflow (i.e.  $Count \geq Target$ ) but rather when the count reaches the target (i.e.  $Count = Target$ ). The timing diagram below illustrates the principle for the Up Counter.

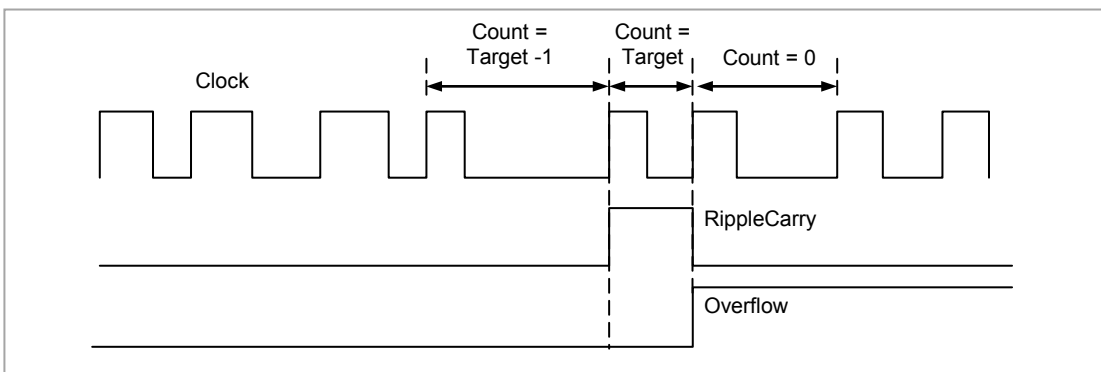

**Figure 15-3: Timing Diagram for an Up Counter**

## 15.1.1 Counter Parameters

List Header - Count		Sub-headers: 1 to 2			
Name ⊙ to select	Parameter Description	Value Press ▼ or ▲ to change values		Default	Access Level
Enable	Counter enable. Counter 1 or 2 is enabled in the Instrument configuration page but they can also be turned on or off in this list	Yes No	Enabled Disabled	Yes	L3
Direction	Defines count up or count down. This is not intended for dynamic operation (i.e. subject to change during counting). It can only be set in configuration level.	Up Down	Up counter Down counter	Up	L3
Ripple Carry	Ripple carry to act as an enabling input to the next counter. It is turned On when the counter reaches the target set	Off On			R/O
Overflow	Overflow flag is held true (Yes) when the counter reaches zero (Down) or passes target (Up)	No Yes			R/O
Clock	Tick period to increment or decrement the count. This is normally wired to an input source such as a digital input.	0 1	No clock input Clock input present	0	R/O if wired
Target	Level to which the counter is aiming	0 to 99999			L3
Count	Counts each time a clock input occurs until the target is reached.	0 to 99999			R/O
Reset	Resets the counter	No Yes	Not in reset Reset	No	L3
Clear O'flow	Clear overflow	No Yes	Not cleared Cleared	No	L3



## 15.2 Timers

Up to four timers can be configured. Each one can be configured to a different type and can operate independently of one another.

### 15.2.1 Timer Types

Each timer block can be configured to operate in four different modes. These modes are explained below

#### 15.2.2 On Pulse Timer Mode

This timer is used to generate a fixed length pulse from an edge trigger.

- The output is set to On when the input changes from Off to On.
- The output remains On until the time has elapsed
- If the 'Trigger' input parameter recurs while the Output is On, the Elapsed Time will reset to zero and the Output will remain On
- The triggered variable will follow the state of the output

The diagram illustrates the behaviour of the timer under different input conditions.

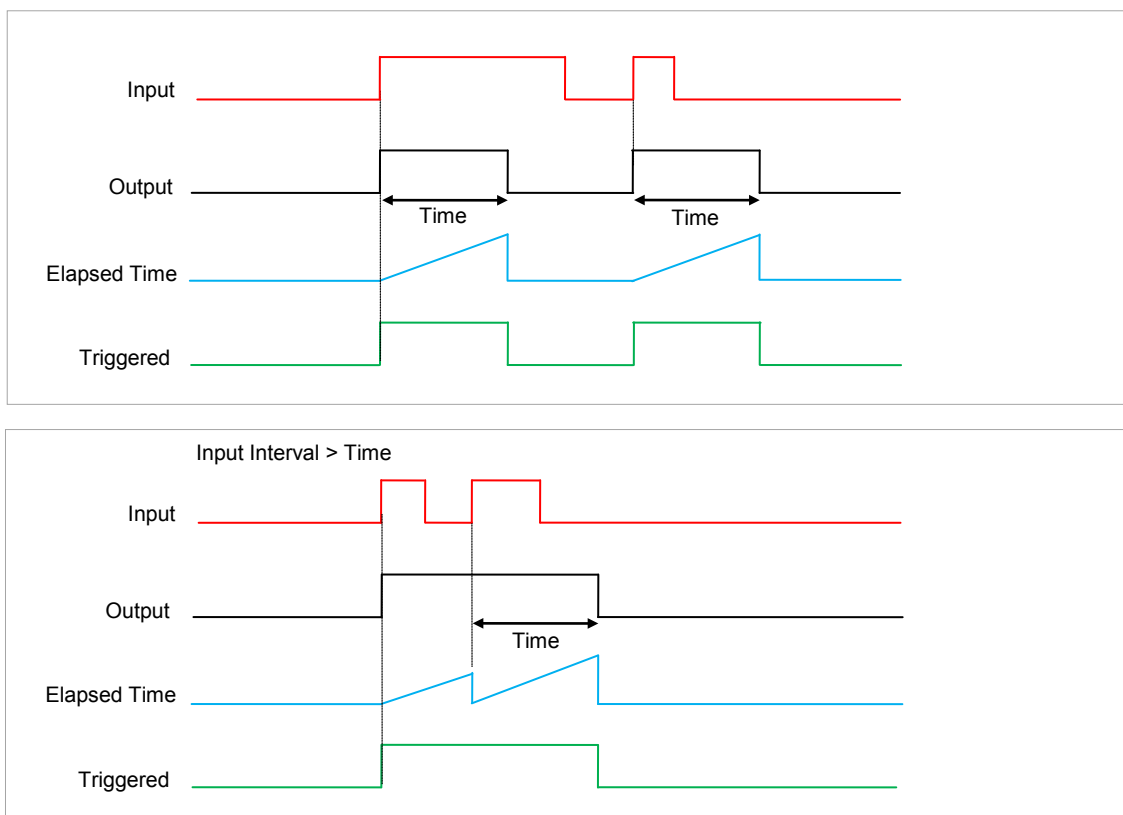

Figure 15-4: On Pulse Timer Under Different Input Conditions

### 15.2.3 On Delay Timer Mode

This timer provides a delay between the trigger event and the Timer output.

- The *Output* is OFF when the *Input* is OFF or has been ON for less than the delay time
- The elapsed time will increment only when the *Input* is ON and will reset to 0 when the *Input* goes OFF.
- With the *Input* ON and once the *Time* has elapsed, the *Output* will be set to ON
- The *Output* will remain On until the *Input* is cleared to Off.
- The *Triggered* variable will follow the *Input*

The following diagrams illustrates the behaviour of the timer under different *Input* conditions.

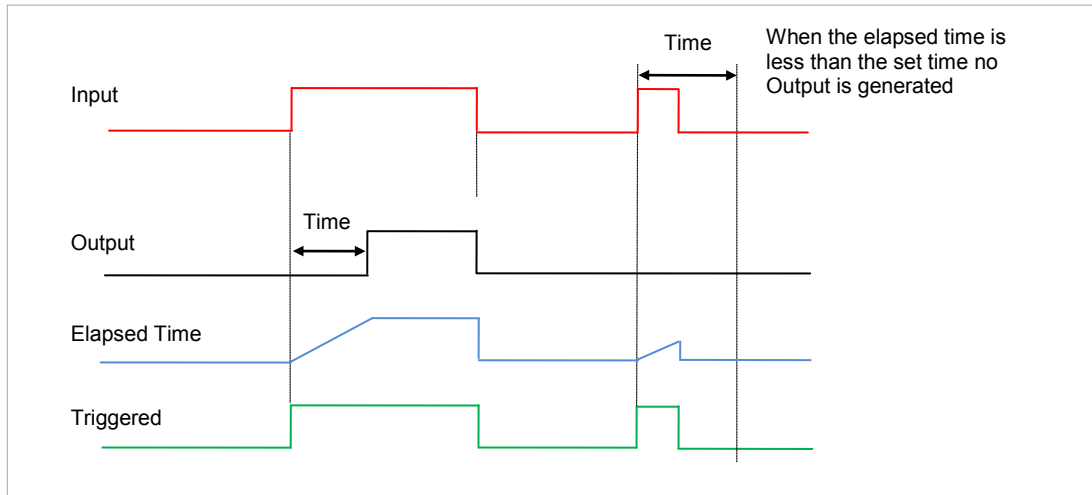

**Figure 15-5: On Delay Timer Under Different Input Conditions**

This type of timer is used to ensure that the output is not set unless the input has been valid for a pre-determined period of time, thus acting as a kind of input filter.

### 15.2.4 One Shot Timer Mode

This timer behaves like a simple oven timer.

- When the Time is edited to a non-zero value the Output is set to On
- The Time value is decremented until it reaches zero. The Output is then cleared to Off
- The Time value can be edited at any point to increase or decrease the duration of the On time
- Once set to zero, the Time is not reset to a previous value, it must be edited by the operator to start the next On-Time
- The Input is used to gate the Output. If the Input is set, the time will count down to zero. If the Input is cleared to Off, then the Time will hold and the Output will switch Off until the Input is next set.



**Note:** Since the Input is a digital wire, it is possible for the operator to NOT wire it, and set the Input value to On which permanently enables the timer.

- The Triggered variable will be set to On as soon as the Time is edited. It will reset when the Output is cleared to Off.

The behaviour of the timer under different input conditions is shown below.

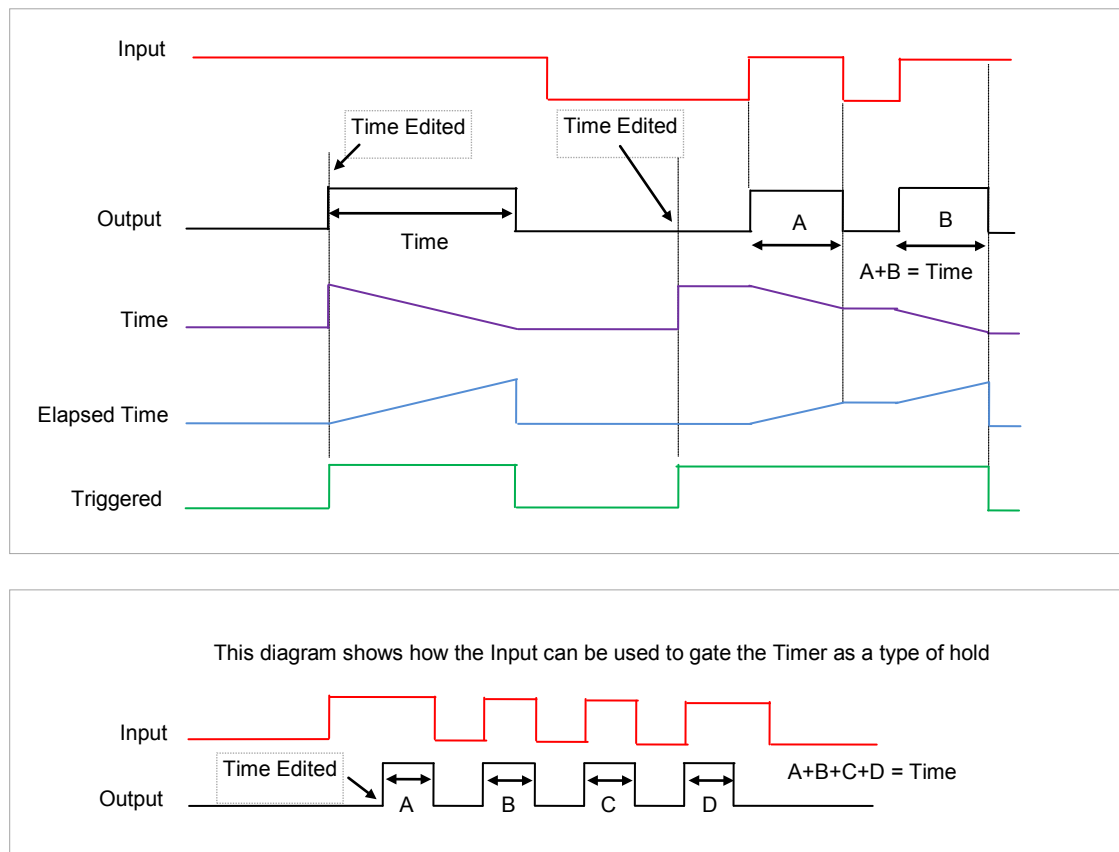

Figure 15-6: One Shot Timer

### 15.2.5 Compressor or Minimum On Timer Mode

This type of timer may also be known as an 'Off Delay' function where the output goes 'on' when the input goes active and remains on for a specified period after the input goes inactive.

It may be used, for example, to ensure that a compressor is not cycled excessively.

- The output will be set to On when the Input changes from Off to On.
- When the Input changes from On to Off, the elapsed time will start incrementing towards the set Time.
- The Output will remain On until the elapsed time has reached the set Time. The Output will then switch Off.
- If the Input signal returns to On while the Output is On, the elapsed time will reset to 0, ready to begin incrementing when the Input switches Off.
- The Triggered variable will be set while the elapsed time is  $>0$ . It will indicate that the timer is counting.

The diagram illustrates the behaviour of the timer under different input conditions.

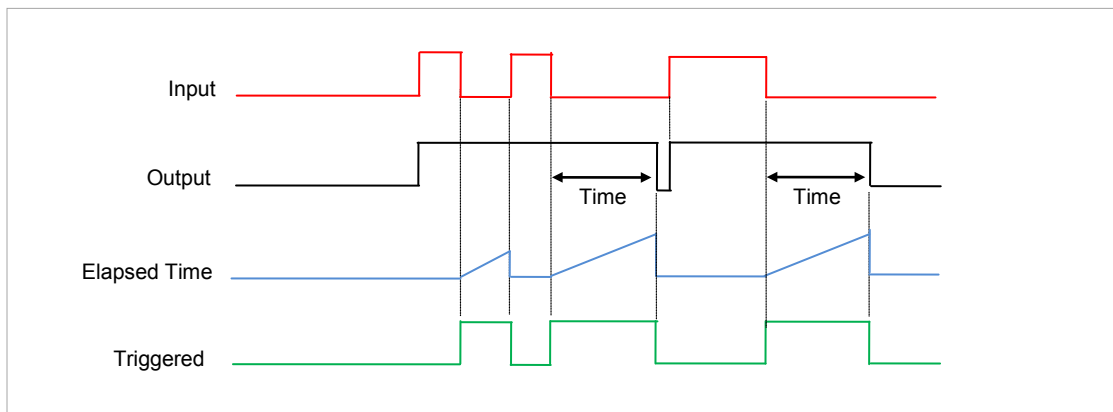

Figure 15-7: Minimum On Timer Under Different Input Conditions

## 15.2.6 Timer Parameters

List Header - Timer		Sub-headers: 1 to 4			
Name ⊙ to select	Parameter Description	Value Press ▼ or ▲ to change values		Default	Access Level
Type	Timer type	Off	Timer not configured	Off or as ordered	Conf
		On Pulse	Generates a fixed length pulse from an edge trigger		
		On Delay	Provides a delay between input trigger event and timer output		
		One Shot	Simple oven timer which reduces to zero before switching off		
		Min-On	Compressor timer guaranteeing that the output remains ON for a time after the input signal has been removed		
Time	Duration of the timer. For re-trigger timers this value is entered once and copied to the time remaining parameter whenever the timer starts. For pulse timers the time value itself is decremented.	0:00.0 to 99:59:59			L3
Elapsed Time	Timer elapsed time	0:00.0 to 99:59:59			R/O L3
Input	Trigger/Gate input. Turn On to start timing	Off On	Off Start timing	Off	L3
Output	Timer output	Off On	Output off Timer has timed out		L3
Triggered	Timer triggered (timing). This is a status output to indicate that the timers input has been detected	Off On	Not timing Timer timing		R/O L3

The above table is repeated for Timers 2 to 4.

### 15.3 Totalisers

A totaliser is an electronic integrator, primarily used to record the numeric total over time of a measured value that is expressed as a rate. For example, the number of litres (since reset), based on a flow rate in litres per minute.

There are two totaliser function blocks in 3500 controllers. A totaliser can, by soft wiring, be connected to any measured value. The outputs from the totaliser are its integrated value and an alarm state. The user may set a setpoint which causes the alarm to activate once the integration exceeds the setpoint.

The totaliser has the following attributes:-

1. Run/Hold/Reset

In Run the totaliser will integrate its input and continuously test against an alarm setpoint. The higher the value of the input the faster the integrator will run.

In Hold the totaliser will stop integrating its input but will continue to test for alarm conditions.

In Reset the totaliser will be zeroed, and alarms will be reset.

2. Alarm Setpoint

If the setpoint is a positive number, the alarm will activate when the total is greater than the setpoint.

If the setpoint is a negative number, the alarm will activate when the total is lower (more negative) than the setpoint.

If the totaliser alarm setpoint is set to 0.0, the alarm will be off. It will not detect values above or below.

The alarm output is a single state output. It may be cleared by resetting the totaliser, stopping the Run condition, or by changing the alarm setpoint.

3. The total is limited to a maximum of 99999 and a minimum of -99999.

4. The totaliser ensures that resolution is maintained when integrating small values onto a large total.

## 15.3.1 Totaliser Parameters

List Header - Total		Sub-headers: 1 to 2			
Name ⌚ to select	Parameter Description	Value Press ⏴ or ⏵ to change values		Default	Access Level
Total	The totalised value	99999 t o-19999			R/O L3
In	The value to be totalised	-9999.9 to 9999.9. <a href="#">Note 1:-</a>			L3
Units	Totaliser units	None AbsTemp V, mV, A, mA, PH, mmHg, psi, Bar, mBar, %RH, %, mmWG, inWG, inWW, Ohms, PSIG, %O2, PPM, %CO2, %CP, %/sec, RelTemp Vacuum sec, min, hrs,			Conf
Res'n	Totaliser resolution	XXXXXX XXXX.X XXX.XX XX.XXX X.XXXX		XXXXXX	Conf
Alarm SP	Sets the totalised value at which an alarm will occur	-99999 to 99999			L3
Alarm OP	This is a read only value which indicates the alarm output On or Off. The totalised value can be a positive number or a negative number. If the number is positive the alarm occurs when Total > + Alarm Setpoint If the number is negative the alarm occurs when Total > - Alarm Setpoint	Off On	Alarm inactive Alarm output active	Off	L3
Run	Runs the totaliser	No Yes	Timer not running Select Yes to run the timer	No	L3
Hold	Holds the totaliser at its current value <a href="#">Note 2:</a>	No Yes	Timer not in hold Hold timer	No	L3
Reset	Resets the totaliser	No Yes	Timer not in reset Timer in reset	No	L3



**Note 1:** The totaliser stops accumulating if the input is 'Bad'.



**Note 2:** The Run & Hold parameters are designed to be wired to (for example) digital inputs. Run must be 'on' and Hold must be 'off' for the totaliser to operate.

## 15.4 Real Time Clock

A real time clock is used to provide a daily and weekly scheduling facility and provides two corresponding alarms. The configuration for an alarm is an On-Day and an On-Time and an Off-Day and an Off-Time.

The day options supported are:-

Day Option	Description
Never	Disables the alarm feature
Monday	Alarm will only be available on a Monday
Tuesday	Alarm will only be available on a Tuesday
Wednesday	Alarm will only be available on a Wednesday
Thursday	Alarm will only be available on a Thursday
Friday	Alarm will only be available on a Friday
Saturday	Alarm will only be available on a Saturday
Sunday	Alarm will only be available on a Sunday
Mon-Fri	Alarm will only be available between Monday to Friday
Mon-Sat	Alarm will only be available on between Monday to Saturday
Sat-Sun	Alarm will only be available on between Saturday to Sunday
Everyday	Alarm always available

For example, it is possible to configure an alarm to be activated at 07:30 on Monday and deactivated at 17:15 on Friday

The output from the Real Time Clock alarms may be used to place the instrument in standby or to sequence a batch process.

The Real Time Clock function will set/clear the alarm outputs only at the time of the alarm. Therefore, it is possible to manually override the alarms by editing the output to On/Off between alarm activations.

The Real Time Clock does not display date or year.

### 15.4.1 Real Time Clock Parameters

List Header - RTClock		Sub-headers: None			
Name Ⓞ to select	Parameter Description	Value Press ▼ or ▲ to change values		Default	Access Level
Mode	This parameter can be used to set the clock	Running Edit Stopped	Normal operation Allows the clock to be set Clock stopped (saves battery life)	Running	L3
Day	Displays the day or allows the day to be set when in Edit mode	See table above			L3
Time	Displays the time or allows the time to be set when in Edit mode	00:00:00 to 23:59:59			L3
On Day1 On Day2	Days when alarm 1 and 2 are activated	See table above			L3
On Time1 On Time2	Time of day when alarm 1 and 2 are activated	00:00:00 to 23:59:59			L3
Off Day1 Off Day2	Days when alarm 1 and 2 are de-activated	See table above			L3
Off Time1 Off Time2	Time of day when alarm 1 and 2 are de-activated	00:00:00 to 23:59:59			L3
Out1 Out2	Alarm 1 and 2 output	Off On	Alarm output not activated Alarm output activated		L3



## 16. Chapter 16 Application Specific

### 16.1 Humidity Control

Humidity (and altitude) control is a standard feature of the 3500 controller. In these applications the controller may be configured to generate a setpoint profile (see Chapter 22 'Programmer Operation'). Also the controller may be configured to measure humidity using either the traditional Wet/Dry bulb method (figure 16.1) or it may be interfaced to a solid state sensor.

The controller output may be configured to turn a refrigeration compressor on and off, operate a bypass valve, and possibly operate two stages of heating and/or cooling

#### 16.1.1 Example of Humidity Controller Connections

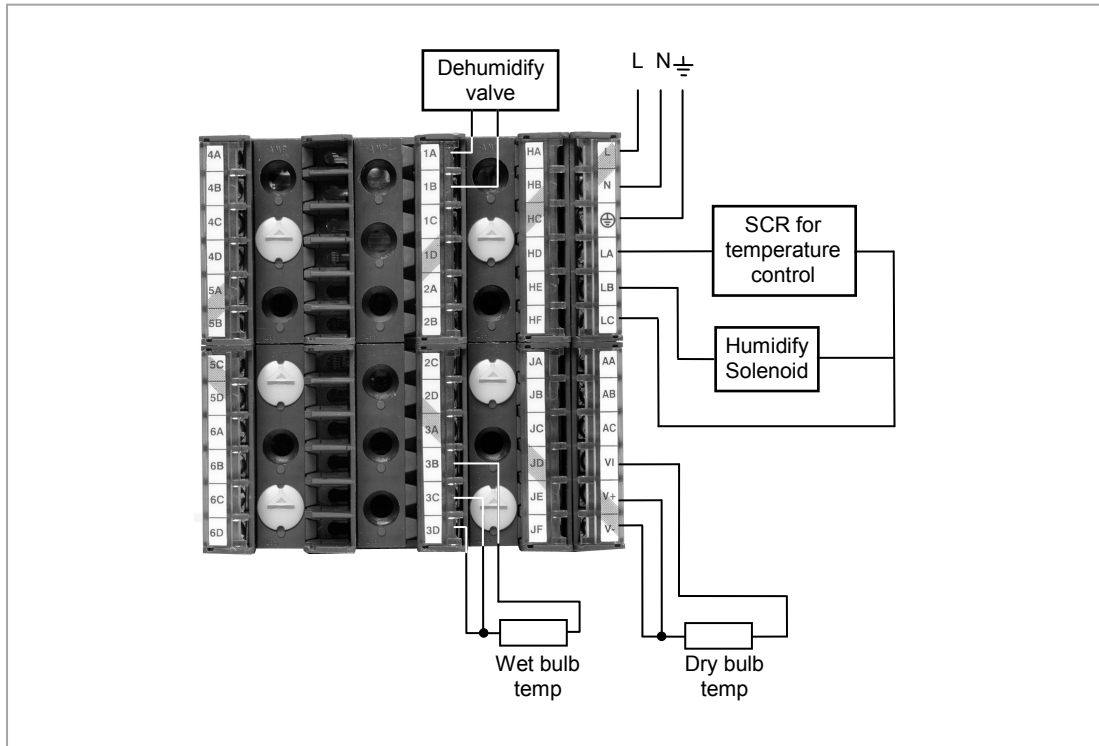

In the above example the following modules are fitted. This will change from installation to installation:

Module 1	Analogue or relay to drive dehumidify valve
Module 3	PV input module for wet bulb temperature RTD
Standard Digital I/O	Used as logic outputs for humidify solenoid valve and temperature control SCR
Standard PV Input	For the dry bulb RTD used for the temperature control and humidity calculation

**Figure 16-1: Example of Humidity Controller Connections**

### 16.1.2 Temperature Control Of An Environmental Chamber

The temperature of an environmental chamber is controlled as a single loop with two control outputs. The heating output time proportions electric heaters, usually via a solid state relay. The cooling output operates a refrigerant valve which introduces cooling into the chamber. The controller automatically calculates when heating or cooling is required.

### 16.1.3 Humidity Control Of An Environmental Chamber

Humidity in a chamber is controlled by adding or removing water vapour. Like the temperature control loop two control outputs are required, i.e. Humidify and Dehumidify.

To humidify the chamber water vapour may be added by a boiler, an evaporating pan or by direct injection of atomised water.

If a boiler is being used adding steam increases the humidity level. The humidify output from the controller regulates the amount of steam from the boiler that is allowed into the chamber.

An evaporating pan is a pan of water warmed by a heater. The humidify output from the controller humidity regulates the temperature of the water.

An atomisation system uses compressed air to spray water vapour directly into the chamber. The humidify output of the controller turns on or off a solenoid valve.

Dehumidification may be accomplished by using the same compressor used for cooling the chamber. The dehumidify output from the controller may control a separate control valve connected to a set of heat exchanger coils.

## 16.2 Humidity Parameters

List Header - Humidity		Sub-headers: None			
Name ⌚ to select	Parameter Description	Value Press ⏴ or ⏵ to change values		Default	Access Level
Res'n	Resolution of the relative humidity	XXXXX XXXX.X XXX.XX XX.XXX X.XXXX			Conf
PsychK	The psychrometric constant at a given pressure (6.66E-4 at standard atmospheric pressure). The value is dependent on the speed of air-flow across the wet bulb, and hence the rate of evaporation. 6.66E-4 is for the ASSMANN ventilated Psychrometer.	0.0 to 10.0		6.66	L3
Pressure	Atmospheric Pressure	0.0 to 2000.0		1013.0 mbar	L3
WetT	Wet Bulb Temperature	Range units			
WetOffs	Wet bulb temperature offset	-100.0 to 100.0		0.0	L3
DryT	Dry Bulb Temperature	Range units			
RelHumid	Relative Humidity is the ratio of actual water vapour pressure (AVP) to the saturated water vapour pressure (SVP) at a particular temperature and pressure	0.0 to 100.0		100	R/O
DewPoint	The dew point is the temperature to which air would need to cool (at constant pressure and water vapour content) in order to reach saturation	-999.9 to 999.9			R/O
SBreak	Indicates that one of the probes is broken.	No Yes	No sensor break detection Sensor break detection enabled		Conf

### 16.3 Zirconia (Carbon Potential) Control

A 3500 controller may be supplied to control carbon potential, order code ZC. The controller is often a programmer which generates carbon potential profiles. In this section it is assumed that a programmer is used.

**Calculation of PV:** The Process Variable can be Carbon Potential, Dewpoint or Oxygen concentration. The PV is derived from the probe temperature input, the probe mV input and remote gas reference input values. Various probe makes are supported. In the 3500 Carbon Potential and Dewpoint can be displayed together.

The following definitions may be useful:-

#### 16.3.1 Temperature Control

The sensor input of the temperature loop may come from the zirconia probe but it is common for a separate thermocouple to be used. The controller provides a heating output which may be connected to gas burners or thyristors to control electrical heating elements. In some applications a cooling output may also be connected to a circulation fan or exhaust damper.

#### 16.3.2 Carbon Potential Control

The zirconia probe generates a millivolt signal based on the ratio of oxygen concentrations on the reference side of the probe (outside the furnace) to the amount of oxygen in the furnace.

The controller uses the temperature and carbon potential signals to calculate the actual percentage of carbon in the furnace. This second loop generally has two outputs. One output is connected to a valve which controls the amount of an enrichment gas supplied to the furnace. The second output controls the level of dilution air.

#### 16.3.3 Sooting Alarm

In addition to other alarms which may be detected by the controller, the 3500 can trigger an alarm when the atmospheric conditions are such that carbon will be deposited as soot on all surfaces inside the furnace. The alarm may be connected to an output (e.g. relay) to initiate an external alarm.

#### 16.3.4 Automatic Probe Cleaning

The 3500 has a probe clean and recovery strategy that can be programmed to occur between batches or manually requested. At the start of the cleaning process a 'snapshot' of the probe mV is taken, and a short blast of compressed air is used to remove any soot and other particles that may have accumulated on the probe. A minimum and maximum cleaning time can be set by the user. If the probe mV has not recovered to within 5% of the snapshot value within the maximum recovery time set then an alarm is given. This indicates that the probe is ageing and replacement or refurbishment is due. During the cleaning and recovery cycle the PV is frozen, thereby ensuring continuous furnace operation. A flag 'PvFrozen' is set which can be used in an individual strategy, for example to hold the integral action during cleaning.

#### 16.3.5 Endothermic Gas Correction

A gas analyser may be used to determine the CO concentration of the endothermic gas. If a 4-20mA output is available from the analyser, it can be fed into the 3500 to automatically adjust the calculated % carbon reading. Alternatively, this value can be entered manually.

#### 16.3.6 Clean Probe

As these sensors are used in furnace environments they require regular cleaning. Cleaning (Burn Off) is performed by forcing compressed air through the probe. Cleaning can be initiated either manually or automatically using a timed period. During cleaning the PV output is frozen.



#### 16.3.7 Probe Status



After cleaning an alarm output, MinCalcT, is generated if the PV does not return to 95% of its previous value within a specified time. This indicates that the probe is deteriorating and should be replaced.

### 16.4 Zirconia Parameters



From firmware versions V2.81 onwards, the Zirconia block contains Probe Types which should be used in new installations and, for backwards compatibility, Probe Types which are already in use in existing installations. A new controller defaults to a newer Probe Type e.g. 'Eurotherm'. With the newer probe types two additional sub-headers - 'GasRefs' and 'Clean', each containing further parameters, are available.

The three headers are shown as:

1. Zirconia  For clarity in this manual, parameter tables shown below in this sub-header are split by probe types as Table 1, Table 2 and Table 3, although the controller shows them as a single list.
2. Zirconia  GasRefs
3. Zirconia  Clean

To select the required sub-header press  or .





Older 'Probe Type' equations are prefixed by 'x', and if one of these is chosen the two extra sub-headers are not available. These types are for backward compatibility and are not recommended for new applications. The parameters applicable to these probes are shown in Zirconia Tables 2 and 3.

 **Note:** If the Probe Type is then changed back to a newer type then it is necessary to press  to reveal , on the top line, and access to the sub-headers.

In all tables, parameters are available in Level 3 and Configuration level. R/O = Read Only parameters in both levels.

#### Zirconia Table 1

For new installations the Probe Types shown in the following table should be used.

List Header - Zirconia		Sub-headers: 			
Name  to select	Parameter Description	Value Press  or  to change values		Default	Access Level
Probe Type	Configures the type of probe to be used.  Enumerations shown in brackets are not displayed on the controller user interface. However, if iTools is used to configure the controller then the enumerations are shown in iTools.	Eurotherm (35) AllPrbMv (34) AllFeronova (33) AllBarber (32) AllBosch (31) AllMacD (30) AllSSI (29) AllAccu (28) AllDrayton (27) AllAACC (26) AllMMI (25)	Eurotherm Probe mV Feronova Barber-Colman Bosch Oxygen MacDhui SSI Accucarb Drayton AACC MMI Carbon	Eurotherm	L3
Resol'n	Resolution of the calculated result	XXXXX XXXX.X XXX.XX XX.XXX X.XXXX			L3
MinCalcTp	Minimum temperature at which the calculation will be valid	-99999 to 99999	720		L3
Tolerance	Tolerance of the sooting	-9999.9 to 9999.9	1.0		L3
ProcFact	Process factor. Only shown if 'ProbeTyp' = AllMMI	1.0 to 999.0		140.0	L3
OxygenExp	The exponent units of the log oxygen type calculation. Only shown for O2 probes.	-24 to 24	2		L3
TemplInput	Zirconia probe temperature input value	Temp range	0		L3
TempOffs	Sets a temperature offset for the probe	-99999 to 99999	0		L3

List Header - Zirconia		Sub-headers: ⚡			
Name ⌚ to select	Parameter Description	Value Press ⏴ or ⏵ to change values		Default	Access Level
ProbelP	Zirconia probe mV input	-99999 to 99999	0		L3
ProbeOffs	Zirconia probe mV offset	-99999 to 99999	0		L3
CarbonPot	Calculated carbon potential. Not if ProbeType = xZircoDew				R/O
DewPoint	Zirconia control process value The O2 or dew point value derived from temperature and remote gas reference inputs				R/O
Oxygen	Calculated oxygen. Only shown for O2 probe types.		0		R/O
SootAlm	Probe sooting alarm output. Not if ProbeType = xZircoDew	No Yes	No alarm output In alarm		R/O
PVFrozen	This is a Boolean which freezes the PV during a purging cycle. It may have been wired, for example, to disable control output during purging	No Yes			R/O
ProbeStat	Indicates the status of the probe	OK	Normal working		R/O
		mVSbr	Probe input in sensor break		
		TempSbr	Temperature input in sensor break		
		MinCalcT	Probe deteriorating		
BalInt	Balance Integral. This output goes true when a step change in the output occurs which will require an integral re-balance if the readings are used in a PID control loop	No Yes			R/O
aC_CO_O2	Carbon Activity Between CO and O2. The carbon activity for the surface gas reaction between CO and Oxygen			0.0000	R/O
PrbState	Probe State. The current state of the probe measurement system. If this is not 'Measure' then the outputs will not be being updated.	Measure Clean Clean Recovery TestImpedance ImpedanceRecovery Not Ready			R/O
OxygenTyp	Oxygen Type. Selects the oxygen algorithm to be used	Nernst NernstBo NernstCP Ferronova	Nernst Nernst Bosch NernstCP Ferronova	Nernst	L3

**Zirconia Table 2**

Probe Type equations shown in Table 2 are no longer recommended and are included for compatibility with existing installations. Table 2 does not include Oxygen only probes.

List Header - Zirconia		Sub-headers: ⇩			
Name Ⓞ to select	Parameter Description	Value Press Ⓞ or ▲ to change values		Default	Access Level
Probe Type	Configures the type of probe to be used.  Values shown here - prefixed by x - are no longer used but are included for backwards compatibility.	xBarberC (21)	Barber-Colman		
		xBoschCrb (20)	Bosch Carbon		
		xProbeMV (19)	Probe mV		
		xZircDew (18)	Dewpoint		
		xMacDhui (14)	MacDhui		
		xSSI (13)	SSI		
		xAccucarb (12)	Accucarb		
		xDrayton (11)	Drayton		
		xAACC (10)	AACC		
		xMMICarb (0)	MMI Carbon		
Resol'n	Resolution of the calculated result	XXXXX XXXX.X XXX.XX XX.XXX X.XXXX			L3
GasRef	Reference value for the hydrogen concentration of the atmosphere	-9999.9 to 9999.9		20.0	L3
RemGasRef	Remote reference value for the hydrogen concentration of the atmosphere, so that the hydrogen concentration may be read from an external source.	-9999.9 to 9999.9		0.0	L3
RemGasEn	Allows the remote gas measurement to be enabled by an external stimuli.	No Yes	Internal External	No	L3
WrkGas	Working reference gas value			20.0	R/O
MinCalcTp	Minimum temperature at which the calculation will be valid	-99999 to 99999		720	L3
Tolerance	Tolerance of the sooting	-9999.9 to 9999.9		1.0	L3
ProcFact	Process factor. Only shown if 'ProbeTyp' = 'xMMICarb'.	1.0 to 999.0		140.0	
CleanFreq	The interval between cleaning cycles of the probe.	0:00:00 to 99:59:59 or 100:00 to 500:00		4:00:00	L3
CleanTime	Sets the duration of the clean	0:00:00 to 99:59:59 or 100:00 to 500:00		0:00:00	L3
MinRcvTim	Minimum recovery time after purging	0:00:00 to 99:59:59 or 100:00 to 500:00		0:00:00	L3
MaxRcvTim	Maximum recovery time after purging	0:00:00 to 99:59:59 or 100:00 to 500:00		0:10:00	L3
TempInput	Zirconia probe temperature input value	Temp range		0	L3
TempOffs	Sets a temperature offset for the probe	-99999 to 99999		0	L3
ProbeIP	Zirconia probe mV input	-99999 to 99999		0	L3
ProbeOffs	Zirconia probe mV offset	-99999 to 99999		0	L3
CarbonPot	Calculated carbon potential. Not if ProbeType = xZircDew				R/O
DewPoint	Zirconia control process value The O2 or dew point value derived from temperature and remote gas reference inputs				R/O
SootAlm	Probe sooting alarm output. Not if ProbeType = xZircDew	No Yes	No alarm output In alarm		L3 R/O

List Header - Zirconia		Sub-headers: ⚡			
Name ⌚ to select	Parameter Description	Value Press ⏴ or ⏵ to change values		Default	Access Level
ProbeFlt	Probe Fault. Indicates a sensor break fault.	No Yes			L3
PVFrozen	This is a Boolean which freezes the PV during a purging cycle. It may have been wired, for example, to disable control output during purging	No Yes			R/O
CleanValv	Enable the clean valve	No Yes			R/O
CleanStat	The burn off state of the zirconia probe	Waiting Cleaning Recovering			R/O
CleanProb	Enable clean probe This may be wired to initiate automatically or if un-wired can be set by the user	No Yes	Do not clean probe Initiate probe clean	No	L3
Time2CIn	Time to next clean	0:00:00 to 99:59:59 or 100:00 to 500:00			L3 R/O
ProbeStat	Indicates the status of the probe	OK	Normal working		L3 R/O
		mVSbr	Probe input in sensor break		
		TempSbr	Temperature input in sensor break		
		MinCalcT	Probe deteriorating		

**Zirconia Table 3**

Probe Type equations shown in Table 3 are no longer recommended and are included for compatibility with existing installations. Table 3 **includes** Oxygen probes only. i.e. xBoschO2 (17), xLogO2 (16), X%O2 (15).

List Header - Zirconia		Sub-headers: ⚡			
Name Ⓞ to select	Parameter Description	Value Press ⏴ or ⏵ to change values		Default	Access Level
Probe Type	Configures the type of probe to be used. Values shown here - prefixed by x - are no longer used but are included for backwards compatibility.	xBoschO2 (17)	Bosch Oxygen		
		xLogO2 (16)	Log Oxygen		
		X%O2 (15)	Oxygen		
Resol'n	Resolution of the calculated result	XXXXX			L3
		XXXX.X			
		XXX.XX			
		XX.XXX			
		X.XXXX			
MinCalcTp	Minimum temperature at which the calculation will be valid	-99999 to 99999		720	L3
OxygenExp	The exponent units of the log oxygen type calculation. Only shown for O2 probes.	-24 to 24		2	
TempInput	Zirconia probe temperature input value	Temp range		0	L3
TempOffs	Sets a temperature offset for the probe	-99999 to 99999		0	L3
ProbeIP	Zirconia probe mV input	-99999 to 99999		0	L3
ProbeOffs	Zirconia probe mV offset	-99999 to 99999		0	L3
Oxygen	Calculated oxygen. Only shown for O2 probe types.			0	L3
ProbeFlt	Probe Fault. Indicates a sensor break fault.	No			L3
		Yes			
PVFrozen	This is a Boolean which freezes the PV during a purging cycle. It may have been wired, for example, to disable control output during purging	No			R/O
		Yes			
ProbeStat	Indicates the status of the probe	OK	Normal working		L3 R/O
		mVSbr	Probe input in sensor break		
		TempSbr	Temperature input in sensor break		
		MinCalcT	Probe deteriorating		



**Gas References (only shown for Probe Types NOT prefixed by 'x')**

List Header - Zirconia		Sub-headers: ↕ GasRefs			
Name ⌂ to select	Parameter Description	Value Press ⏴ or ⏵ to change values		Default	Access Level
CO_Local	Reference value for the CO concentration of the atmosphere	0.1 to 100.0		20.0	
CO_Remote	Remote reference value for the CO concentration of the atmosphere, so that the CO concentration may be read from an external source.	0.1 to 100.0		0.1	
CO_RemEn	CO Remote Enable. Allows the remote gas measurement to be enabled by an external stimulus.	No Yes	Not enabled Enabled	No	
CO_Inuse	The CO gas measurement value currently being used.			20.0	R/O
H2_Local	Reference value for the hydrogen concentration of the atmosphere	0.1 to 100.0		40.0	
H2_Remote	Remote reference value for the hydrogen concentration of the atmosphere, so that the hydrogen concentration may be read from an external source	0.1 to 100.0		0.1	
H2_RemEn	Hydrogen Remote Enable. Allows the remote gas measurement to be enabled by an external stimulus.	No Yes	Not enabled Enabled		
H2_InUse	The hydrogen gas measurement value currently being used.			40.0	R/O

**Clean (only shown for Probe Types NOT prefixed by 'x')**

List Header - Zirconia		Sub-headers: ↕ Clean		
Name Ⓞ to select	Parameter Description	Value Press Ⓞ or Ⓜ to change values	Default	Access Level
CleanFreq	Probe clean frequency. The interval between cleaning cycles of the probe.	0:00:00 to 500:00	4::00:00	
CleanTime	Probe clean time. The time for which the zirconia probe is cleaned.	0:00:00 to 500:00	0::03:00	
MinRcvTim	Minimum recovery time after a purge	0:00:00 to 500:00	0::00:01	
MaxRcvTim	Maximum recovery time after a purge.	0:00:00 to 500:00	0::01:30	
CleanValv	Enable the clean valve. Output which enables the probe cleaning valve.	No Yes		R/O
CleanProb	Initiate probe clean. A rising edge on this input initiates probe cleaning independant of the cleaning cycle.	Yes No		
Time2Cln	Time to next clean. Calculated from the Clean Freq value and the time elapsed since last clean.	0:00:00 to 500:00		R/O
ClnEnabl	Enable Probe Clean. Probe cleaning is inhibited unless this input is set to Yes.	No Yes	No	Op
ClnMaxT	Maximum Temperature For Cleaning. If the probe temperature exceeds this limit when cleaning is in progress then the clean is aborted.	-99999 to 99999	1100	Op
ClnAbort	Abort Clean Cycle. A rising edge of this input causes the clean to be aborted	No Yes	No	Op
ClnRcovT	Last Clean Recovery Time. The time the probe mV took to recover to 95% of its original value following the last clean. If the last clean did not recover within the maximum clean recovery time then this value will be set to 0.		0.0	R/O
LastCln	mV at end of last clean. The input from the probe when the last clean completed.			R/O
ClnMsgRt	Clear Cleaning Status. A rising edge on this input clears the cleaning related alarms and the probe warning.	No Yes	No	Op
ProbeFit	Probe Clean Recovery Warning. The probe failed to recover to 95% of its original reading following a probe clean cycle.	No Yes		R/O
CantClean	Cant clean status. Conditions exist that prevented a clean cycle from starting. This status can be reset using the ClnMsgRt parameter.	Off On		R/O
CleanAbort	A clean cycle was aborted. This status can be reset using the ClnMsgRt parameter.	Off On		R/O
CleanTemp	A clean cycle was aborted by the temperature rising above Clean Max Temp. This status can be reset using the ClnMsgRt parameter.	Off On		R/O

## 16.5 Example of Carbon Potential Control Connections

In this example the following modules are assumed:-

Module 1 Dual relay or logic output.

Module 3 Analogue Input set to HZ Volts 0 – 2V input.

Module 4 Triple Logic Output

Probe clean digital input is on the LB logic input.

The sooting alarm is operated by the AA Relay.

The temperature is measured on the fixed PV input.

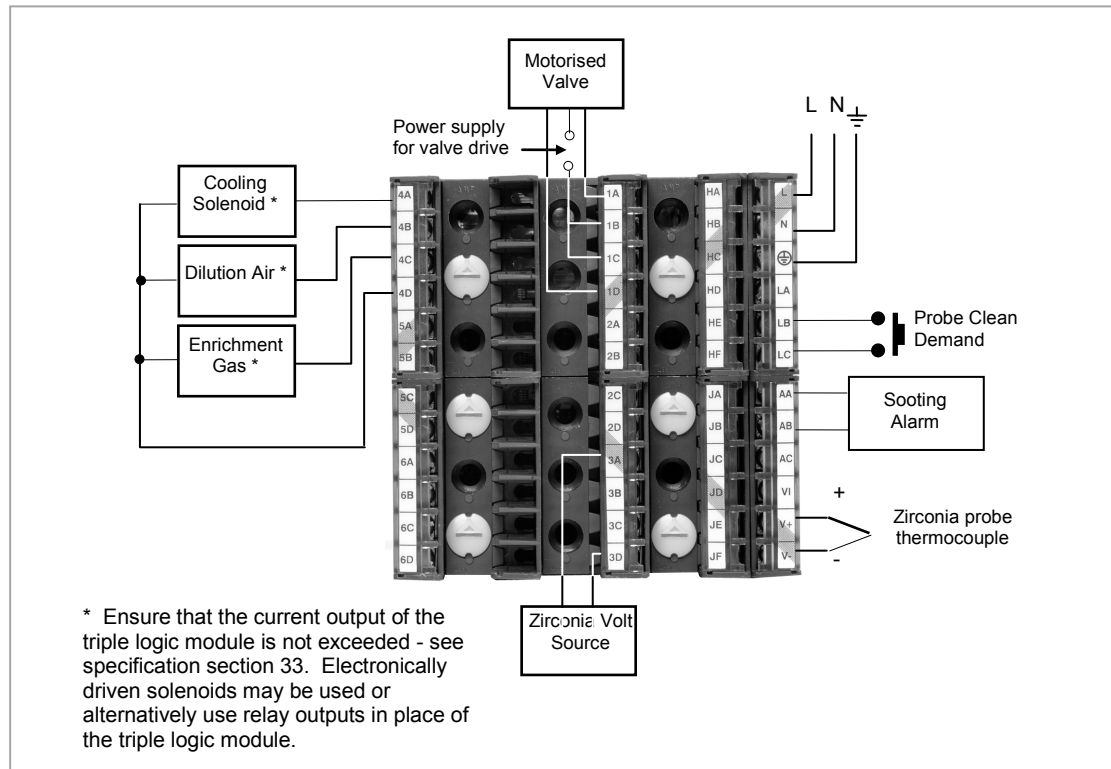

Figure 16-2: Example of Carbon Potential Controller Connections

## 17. Chapter 17 Input Monitor

The input monitor may be wired to any variable in the controller. It then provides three functions:-

1. Maximum detect
2. Minimum detect
3. Time above threshold

### 17.1 Maximum Detect

This function continuously monitors the input value. If the value is higher than the previously recorded maximum, it becomes the new maximum.

This value is retained following a power fail.

### 17.2 Minimum Detect

This function continuously monitors the input value. If the value is lower than the previously recorded minimum, it becomes the new minimum.

This value is retained following a power fail.

### 17.3 Time Above Threshold

This function increments a timer whenever the input is above a threshold value. If the timer exceeds 24 hours per day, a counter is incremented. The maximum number of days is limited to 255. A timer alarm can be set on the timer so that once the input has been above a threshold for a period, an alarm output is given.

Applications include:-

- Service interval alarms. This sets an output when the system has been running for a number of days (up to 90 years)
- Material stress alarms - if the process cannot tolerate being above a level for a period. This is a style of 'policeman' for processes where the high operating point degrades the life of the machine.
- In internal wiring applications in the controller

## 17.4 Input Monitor Parameters



List Header - IPMon		Sub-headers: 1 or 2		
Name ⊙ to select	Parameter Description	Value Press ▼ or ▲ to change values	Default	Access Level
Input	The input value to be monitored	May be wired to an input source. The range will depend on the source		L3. R/O if wired
Max	The maximum measured value recorded since the last reset	As above		R/O L3
Min	The minimum measured value recorded since the last reset	As above		R/O L3
Threshold	The input timer accumulates the time the input PV spends above this trigger value.	As above		L3
Days Above	Accumulated days the input has spent above threshold since the last reset.	Days is an integer count of the 24 hour periods only. The Days value should be combined with the Time value to make the total time above threshold.		R/O L3
Time Above	Accumulated time above the 'Threshold' since last reset.	The time value accumulates from 00:00.0 to 23:59.9. Overflows are added to the days value		R/O L3
Alm Days	Days threshold for the monitors time alarm. Used in combination with the Alm Time parameter. The Alm Out is set to true if the inputs accumulated time above threshold is higher than the timer high parameters.	0 to 255	0	L3
Alm Time	Time threshold for the monitors time alarm. Used in combination with the Alm Days parameter. The Alm Out is set to true if the inputs accumulated time above threshold is higher than the timer high parameters.	0:00.0 to 99:59:59	0:00.0	L3
Alm Out	Set true if the accumulated time that the input spends above the trigger value is higher than the alarm setpoint.	Off On	Normal operation time above setpoint exceeded	R/O L3
Reset	Resets the Max and Min values and resets the time above threshold to zero.	No Yes	Normal operation Reset values	No L3
In Status	Monitors the status of the input	Good Bad	Normal operation The input may be incorrectly wired	R/O L3

## 18. Chapter 18 Logic Maths and multi Operators.

### 18.1 Logic Operators

Logic Operators allow the controller to perform logical calculations on **two** input values. These values can be sourced from any available parameter including Analogue Values, User Values and Digital Values.

The parameters to use, the type of calculation to be performed, input value inversion and 'fallback' value are determined in Configuration level. In levels 1 to 3 you can view the values of each input and read the result of the calculation.

The Logic Operators page is only available if the operators have been enabled in 'Inst' page sub-header 'Opt'. It is possible to enable any one of 24 separate calculations – they do not have to be in sequence. In the 'Inst' 'Opts' page they are shown in three sets of 8 labelled 'Lgc2 En1' (enable operator set 1 to 8), 'Lgc2 En2' (enable operator set 9 to 16), and 'Lgc2 En3' (enable operator set 17 to 24). 'Lgc2' denotes a two input logic operator. When logic operators are enabled a page headed 'Lgc2' can be found using the  button. This page contains up to twenty four instances which are selected using the  or  buttons.

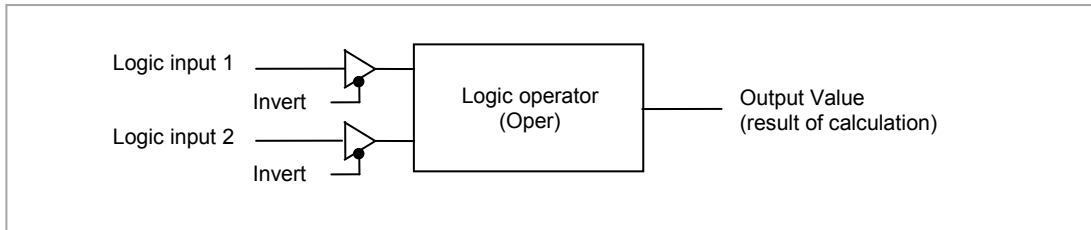





Figure 18-1: 2 Input Logic Operators

Logic Operators are found under the page header 'Lgc2'.

#### 18.1.1 Logic 8

Logic 8 operators can perform logic calculations on up to **eight** inputs. The calculations are limited to AND,OR,XOR. Up to two 8 input operators can be enabled in 'Inst' page sub-header 'Opt'. They are labelled 'Lgc8' to denote eight input logic operators. When Lgc8 operators are enabled a page headed 'Lgc8' can be found using the  button. This page contains up to two instances which are selected using the  or  buttons.

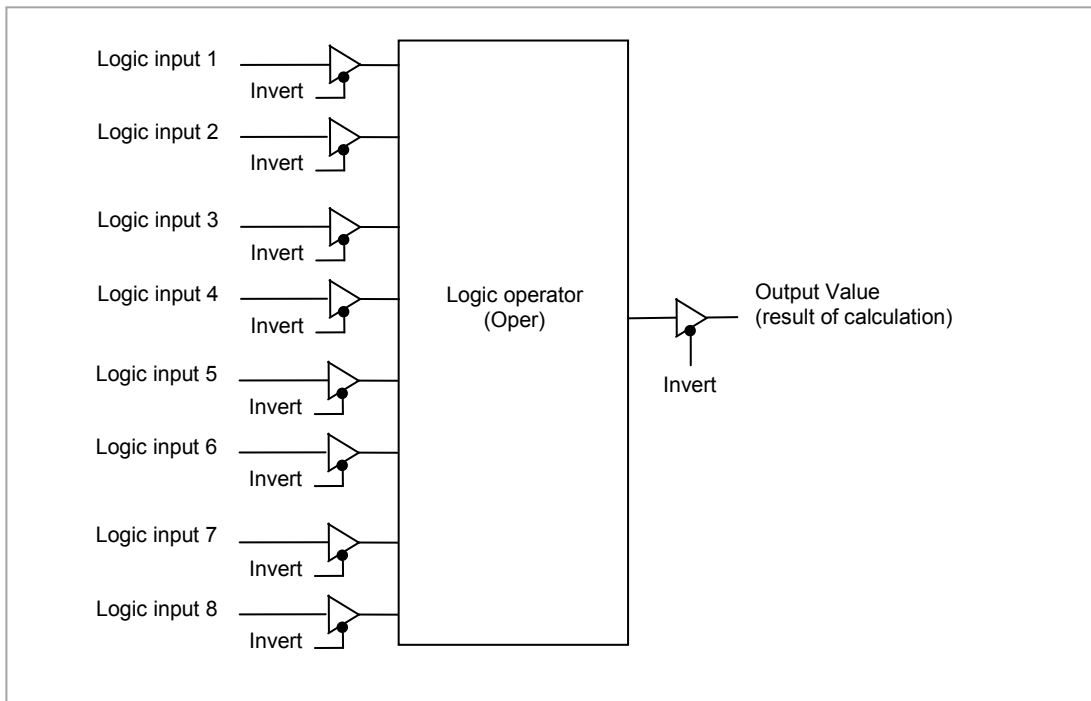

Figure 18-2: 8 Input Logic Operators

### 18.1.2 Logic Operations

The following calculations can be performed:

Oper	Operator description	Input 1	Input 2	Output Invert = None
0: OFF	The selected logic operator is turned off			
1: AND	The output result is ON when both Input 1 and Input 2 are ON	0	0	Off
		1	0	Off
		0	1	Off
		1	1	On
2: OR	The output result is ON when either Input 1 or Input 2 is ON	0	0	Off
		1	0	On
		0	1	On
		1	1	On
3: XOR	Exclusive OR. The output result is true when one and only one input is ON. If both inputs are ON the output is OFF.	0	0	Off
		1	0	On
		0	1	On
		1	1	Off
4: LATCH	Input 1 sets the latch, Input 2 resets the latch.	0	0	
		1	0	
		0	1	
		1	1	
5: ==	Equal. The output result is ON when Input 1 = Input 2	0	0	On
		1	0	Off
		0	1	Off
		1	1	On
6: <>	Not equal. The output result is ON when Input 1 ≠ Input 2	0	0	Off
		1	0	On
		0	1	On
		1	1	Off
7: >	Greater than. The output result is ON when Input 1 > Input 2	0	0	Off
		1	0	On
		0	1	Off
		1	1	Off
8: <	Less than. The output result is ON when Input 1 < Input 2	0	0	Off
		1	0	Off
		0	1	On
		1	1	Off
9: =>	Equal to or Greater than. The output result is ON when Input 1 ≥ Input 2	0	0	On
		1	0	On
		0	1	Off
		1	1	On
10: <=	Less than or Equal to. The output result is ON when Input 1 ≤ Input 2	0	0	On
		1	0	Off
		0	1	On
		1	1	On



**Note:** The numerical value is the value of the enumeration





**Note:** For options 1 to 4 an input value of less than 0.5 is considered false and greater than or equal to 0.5 as true.

**18.1.3 Logic Operator Parameters**



List Header – Lgc2 (2 Input Operators)		Sub-headers: 1 to 24			
Name ⌚ to select	Parameter Description	Value Press ▼ or ▲ to change values		Default	Access Level
Oper	To select the type of operator	See previous table		None	Conf L3 R/O
Input1	Input 1	Normally wired to a logic, analogue or user value. May be set to a constant value if not wired.		0	L3
Input2	Input 2				
Fall Type	The fallback state of the output if one or both of the inputs is bad	0: FalseBad	The output value is FALSE and the status is BAD.		Conf L3 R/O
		1: TrueBad	The output value is TRUE and the status is BAD		
		2: FalseGood	The output value is FALSE and the status is GOOD		
		3: TrueGood	The output value is TRUE and the status is GOOD.		
Invert	The sense of the input value, may be used to invert one or both of the inputs	0: None	Neither input inverted		Conf L3 R/O
		1: Input1	Invert input 1		
		2: Input2	Invert input 2		
		3: Both	Invert both inputs		
Output	The output from the operation is a boolean (true/false) value.	On Off	Output activated Output not activated		R/O
Status	The status of the result value	Good Bad			R/O



## 18.2 Eight Input Logic Operators

The eight input logic operator may be used to perform operations on eight inputs. It is possible to enable two eight input logic operators from the 'Inst' 'Opt' page. When this is done a page headed 'Lgc8' can be found using the  button. This page contains up to two instances which are selected using the  or  button.

### 18.2.1 Eight Input Logic Operator Parameters

List Header – Lgc8 (8 Input Operators)		Sub-headers: 1 to 2			
Name  to select	Parameter Description	Value Press  or  to change values		Default	Access Level
Oper	To select the type of operator	0: OFF 1: AND 2: OR 3: XOR	Operator turned off Output ON when all inputs are ON Output ON when one input is ON Exclusive OR	OFF	Conf L3 R/O
NumIn	This parameter is used to configure the number of inputs for the operation	1 to 8			Conf L3 R/O
Invert	Used to invert selected inputs prior to operation. This is a status word with one bit per input, the left hand bit inverts input 1.	<input type="checkbox"/> <input type="checkbox"/> <input type="checkbox"/> <input type="checkbox"/> <input type="checkbox"/> <input type="checkbox"/> <input type="checkbox"/> <input type="checkbox"/> No inputs inverted <input checked="" type="checkbox"/> <input checked="" type="checkbox"/> <input checked="" type="checkbox"/> <input checked="" type="checkbox"/> <input checked="" type="checkbox"/> <input checked="" type="checkbox"/> <input checked="" type="checkbox"/> <input checked="" type="checkbox"/> All 8 inputs inverted When configuring over comms, the invert parameter is interpreted as a bitfield where: 0x1 - input 1 0x2 - input 2 0x4 - input 3 0x8 - input 4 0x10 - input 5 0x20 - input 6 0x40 - input 7 0x80 - input 8		<input type="checkbox"/>	L3
Out Invert	Invert the output	No Yes	Output not inverted Output inverted	No	L3
In 1 to In8	Input state 1 to 8	Normally wired to a logic, analogue or user value. When wired to a floating point, values less than or equal to -0.5 or greater than or equal to 1.5 will be rejected (e.g. the value of the lgc8 block will not change). Values between -0.5 and 1.5 will be interpreted as ON when greater than or equal to 0.5 and OFF when less than 0.5. May be set to a constant value if not wired.		Off	L3
Out	Output result of the operator	On Off	Output activated Output not activated		R/O



The eight input logic operator may be used to perform the following operations on 8 inputs:

Oper	Operation Description
0: OFF	The selected logic operator is turned off
1: AND	The output result is ON when ALL 8 inputs are ON
2: OR	The output result is ON when one or more of the 8 inputs are ON
3: XOR	Exclusive OR – the output is ON if an ODD number of inputs are ON. The output is OFF if an even number of inputs are ON.

### 18.3 Maths Operators

Maths Operators (sometimes known as Analogue Operators) allow the controller to perform mathematical operations on two input values. These values can be sourced from any available parameter including Analogue Values, User Values and Digital Values. Each input value can be scaled using a multiplying factor or scalar.

The parameters to use, the type of calculation to be performed and the acceptable limits of the calculation are determined in Configuration level. In access level 3 you can change values of each of the scalars.

The 'Math' Operators page is only available if the operators have been enabled in 'Inst' page sub-header 'Opt'. It is possible to enable any one of 24 separate calculations – they do not have to be in sequence. In the 'Inst' 'Opts' page they are shown in three sets of 8 labelled 'Math2 En1' (enable operator set 1 to 8), 'Math 2 En2' (enable operator set 9 to 16), and 'Math En3' (enable operator set 17 to 24). 'Math2' denotes a two input math operator. When math operators are enabled a page headed 'Math2' can be found using the  button. This page contains up to twenty four instances which are selected using the  or  button.

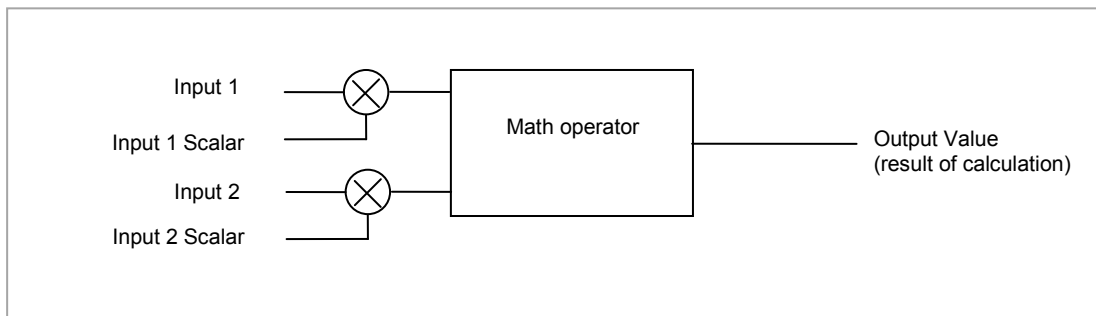

Figure 18-3: 2 Input Math Operators

### 18.3.1 Math Operations

The following operations can be performed:

0: Off	The selected analogue operator is turned off
1: Add	The output result is the addition of Input 1 and Input 2
2: Sub	Subtract. The output result is the difference between Input 1 and Input 2 where Input 1 > Input 2
3: Mul	Multiply. The output result is the Input 1 multiplied by Input 2
4: Div	Divide. The output result is Input 1 divided by Input 2
5: AbsDif	Absolute Difference. The output result is the absolute difference between Input 1 and 2
6: SelMax	Select Max. The output result is the maximum of Input 1 and Input 2
7: SelMin	Select Min. The output result is the minimum of Input 1 and Input 2
8: HotSwp	Hot Swap. Input 1 appears at the output provided input 1 is 'good'. If input 1 is 'bad' then input 2 value will appear at the output. An example of a bad input occurs during a sensor break condition.
9: SmpHld	Sample and Hold. Normally input 1 will be an analogue value and input B will be digital. The output tracks input 1 when input 2 = 1 (Sample). The output will remain at the current value when input 2 = 0 (Hold). If input 2 is an analogue value then any non zero value will be interpreted as 'Sample'.
10: Power	The output is the value at input 1 raised to the power of the value at input 2. I.e. $\text{input 1}^{\text{input 2}}$
11: Sqrt	Square Root. The output result is the square root of Input 1. Input 2 has no effect.
12: Log	The output is the logarithm (base 10) of Input 1. Input 2 has no effect
13: Ln	The output is the logarithm (base n) of Input 1. Input 2 has no effect
14: Exp	The output result is the exponential of Input 1. Input 2 has no effect
15: 10 x	The output result is 10 raised to the power of Input 1 value. I.e. $10^{\text{input 1}}$ . Input 2 has no effect
51: Select	<p>Select input is used to control which Analogue Input is switched to the output of the Analogue Operator. If the select input is true input 2 is switched through to the output. If false input 1 is switched through to the output. See example below:-</p>

When Boolean parameters are used as inputs to analogue wiring, they will be cast to 0.0 or 1.0 as appropriate. Values  $\leq -0.5$  or  $\geq 1.5$  will not be wired. This provides a way to stop a Boolean updating. Analogue wiring (whether simple re-routing or involving calculations) will always output a real type result, whether the inputs were booleans, integers or reals.



**Note:** The numerical value is the value of the enumeration

## 18.3.2 Math Operator Parameters

List Header – Math2 (2 Input Operators)		Sub-headers: 1 to 24		
Name Ⓞ to select	Parameter Description	Value Press Ⓞ or Ⓜ to change values	Default	Access Level
Operation	To select the type of operator	See previous table	None	Conf
Input1 Scale	Scaling factor on input 1	Limited to max float *	1.0	L3
Input2 Scale	Scaling factor on input 2	Limited to max float *	1.0	L3
Output Units	Units applicable to the output value	None AbsTemp V, mV, A, mA, PH, mmHg, psi, Bar, mBar, %RH, %, mmWG, inWG, inWW, Ohms, PSIG, %O2, PPM, %CO2, %CP, %/sec, RelTemp Vacuum sec, min, hrs,	None	Conf
Output Res'n	Resolution of the output value	XXXXX. XXXX.X, XXX.XX, XX.XXX, X.XXXX		Conf
Low Limit	To apply a low limit to the output	Max float* to High limit (decimal point depends on resolution)	-99999	Conf
High Limit	To apply a high limit to the output	Low limit to Max float* (decimal point depends on resolution)	999999	Conf
Fallback	The state of the Output and Status parameters in case of a fault condition. This parameter could be used in conjunction with fallback value	Clip Bad Clip Good Fall Bad Fall Good Upscale DownScale	Descriptions, see section 18.4.2.	Conf
Fallback Val	Defines (in accordance with Fallback) the output value during fault conditions.	Limited to max float * (decimal point depends on resolution)		Conf
Input1 Value	Input 1 value (normally wired to an input source – could be a User Value)	Limited to max float * (decimal point depends on resolution)		L3
Input2 Value	Input 2 value (normally wired to an input source – could be a User Value)	Limited to max float * (decimal point depends on resolution)		L3
Output Value	Indicates the analogue value of the output	Between high and low limits		R/O
Status	This parameter is used in conjunction with Fallback to indicate the status of the operation. Typically, status is used to flag fault conditions and may be used as an interlock for other operations.	Good Bad		R/O

\* Max float in this instrument is ±9,999,999,999

### 18.3.3 Sample and Hold Operation

The diagram below shows the operation of the sample and hold feature.

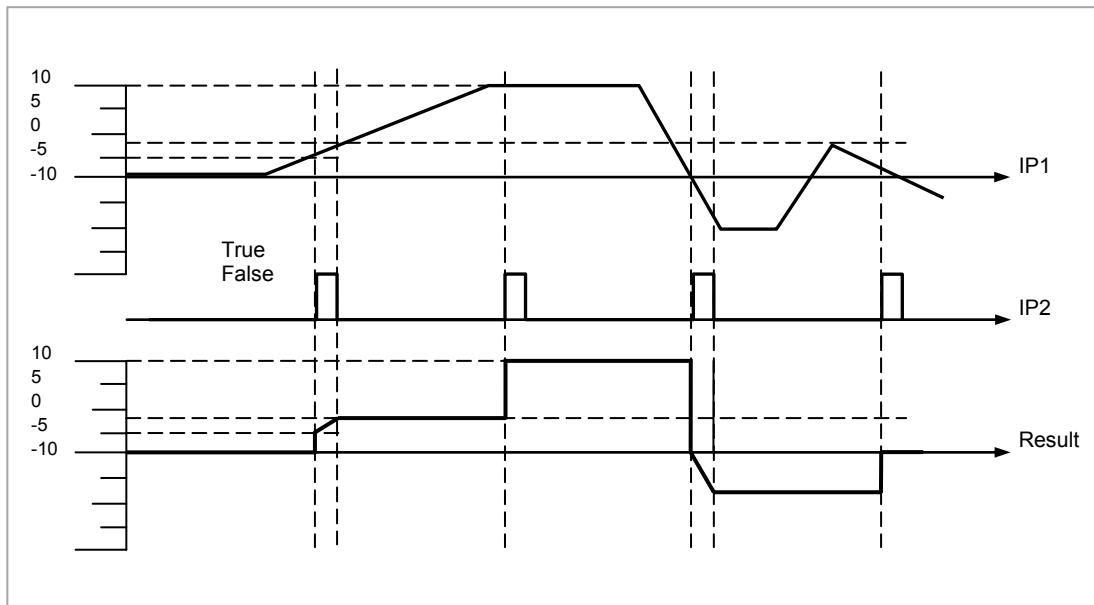







Figure 18-4: Sample and Hold

## 18.4 Eight Input Analog Multiplexers

The eight Input analog multiplexers may be used to switch one of eight inputs to an output. It is usual to wire inputs to a source within the controller which selects that input at the appropriate time or event. Two multiplexers may be enabled from the 'Inst' 'Opt' page. A page headed 'Mux8' can then be found using the  button. This page contains up to two instances which are selected using  or  button.

### 18.4.1 Multiple Input Operator Parameters

List Header – Mux8 (8 Input Operators)		Sub-headers: 1 to 2		
Name  to select	Parameter Description	Value Press  or  to change values	Default	Access Level
High Limit	The high limit for all inputs and the fall back value.	Low Limit to 99999 (decimal point depends on resolution)	99999	Conf
Low Limit	The low limit for all inputs and the fall back value.	-99999 to High Limit (decimal point depends on resolution)	-99999	Conf
Fallback	The state of the Output and Status parameters in case of a fault condition. This parameter could be used in conjunction with Fallback Val.	Clip Bad Clip Good Fall Bad Fall Good Upscale DownScale	Descriptions see section 18.4.2.	Conf
Fallback Val	Used (in accordance with Fallback) to define the output value during fault conditions	-99999 to 99999 (decimal point depends on resolution)		Conf
Select	Used to select which input value is assigned to the output.	Input1 to Input8		L3
Input1 to 8	Input values (normally wired to an input source)	-99999 to 99999 (decimal point depends on resolution)		L3
Output	Indicates the analogue value of the output	Between high and low limits		R/O
Status	Used in conjunction with Fallback to indicate the status of the operation. Typically, status is used to flag fault conditions and may be used as an interlock for other operations.	Good Bad		R/O
Res'n	Indicates the resolution of the output	XXXXX XXXX.X XXX.XX XX.XXX X.XXXX	The resolution of the output is taken from the selected input. If the selected input is not wired, or if its status is bad then the resolution will be set to 1dp	

### 18.4.2 Fallback

The fallback strategy will come into effect if the status of the input value is bad or if the input value is outside the range of Input Hi and Input Lo.

In this case the fallback strategy may be configured as:-

**Fall Good** If the input value is above 'High Limit' or below 'Low Limit', then the output value is set to the 'Fallback' value, and the 'Status' is set to 'Good'.

**Fall Bad** If the input value is above 'High Limit' or below 'Low Limit', then the output value is set to the 'Fallback' value, and the 'Status' is set to 'Bad'.

**Clip Good** If the input value is above 'High Limit' or below 'Low Limit', then the output value is set to the appropriate limit, and 'Status' is set to 'Bad'. If the input signal is within the limits, but its status is bad, the output is set to the 'Fallback' value.

**Clip Bad** If the input value is above 'High Limit' or below 'Low Limit', then the output value is set to the appropriate limit, and 'Status' is set to 'Good'. If the input signal is within the limits, but its status is bad, the output is set to the 'Fallback' value

**Upscale** If the input status is bad, or if the input signal is above 'High Limit' or below 'Low Limit', the output value is set to the 'High Limit'.

**Downscale** If the input status is bad, or if the input signal is above 'High Limit' or below 'Low Limit', the output value is set to the 'Low Limit'.

## 18.5 Multi Input Operator

The Multi Input Operator function block performs analogue operations on up to eight inputs. The block will simultaneously output the Sum, Average, Maximum and Minimum values of the valid inputs. The outputs may be clipped to user defined limits or be replaced by a fallback value as described in section 18.5.5.

An outline of the block is shown below and there are two instances of the block in 3500 series controllers.

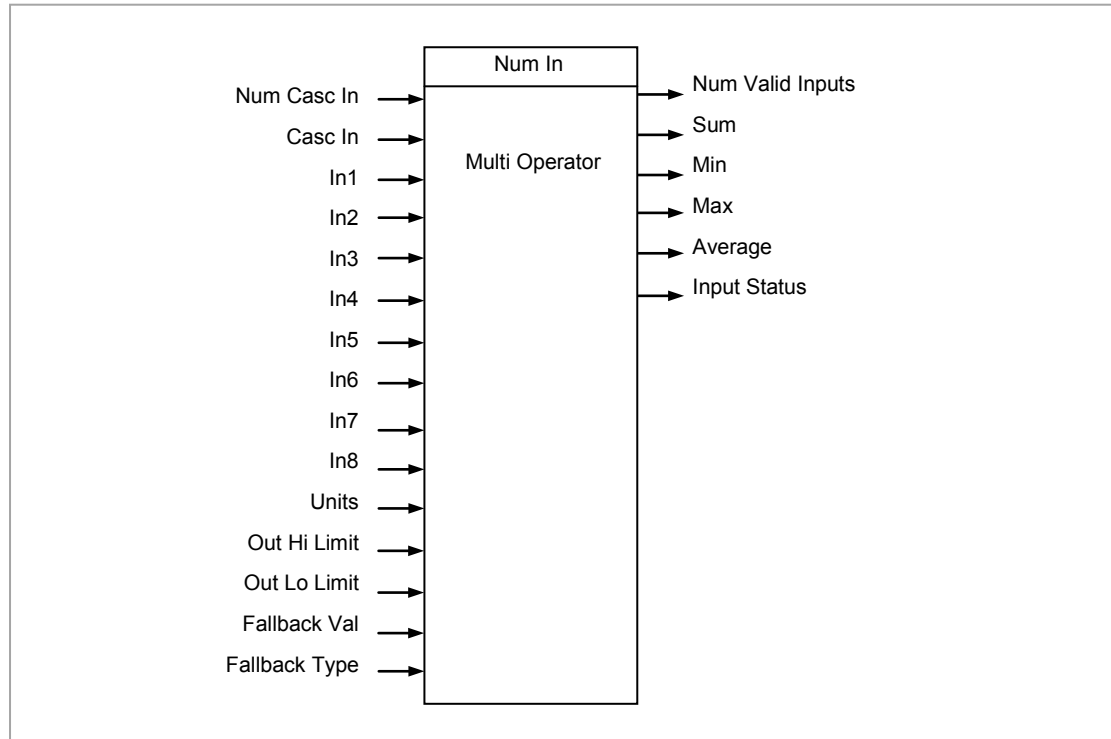

Figure 18-5: Multi Input Operator Function Block

### 18.5.1 Number of Inputs

'Num In' determines the number of inputs made available for use. This is settable by the user and is defaulted to two. Take care not to set this number to a value higher than the desired number of inputs as any unused inputs are seen as valid inputs (zero value by default). 'Num Casc In' and 'Casc In' will always be available.

### 18.5.2 Input Status

'Input Status' gives an indication of the status of the inputs in priority order. 'Casc in' has the highest priority, 'In1' the next highest up to 'In8' the lowest. Should more than one input be bad then the input with the highest priority is shown as bad. When the highest priority bad status is cleared the next highest priority bad status is shown. When all inputs are OK a status of OK is shown.

### 18.5.3 Number of Valid Inputs

'Num Valid Ins' provides a count of the number of inputs used to perform the calculation within the block. This is required for cascaded operation as detailed below.

### 18.5.4 Cascaded Operation

The two Multiple Input Operator blocks can be cascade to allow up to 16 inputs. The diagram shows how the two blocks are configured to find the average of more than eight inputs.

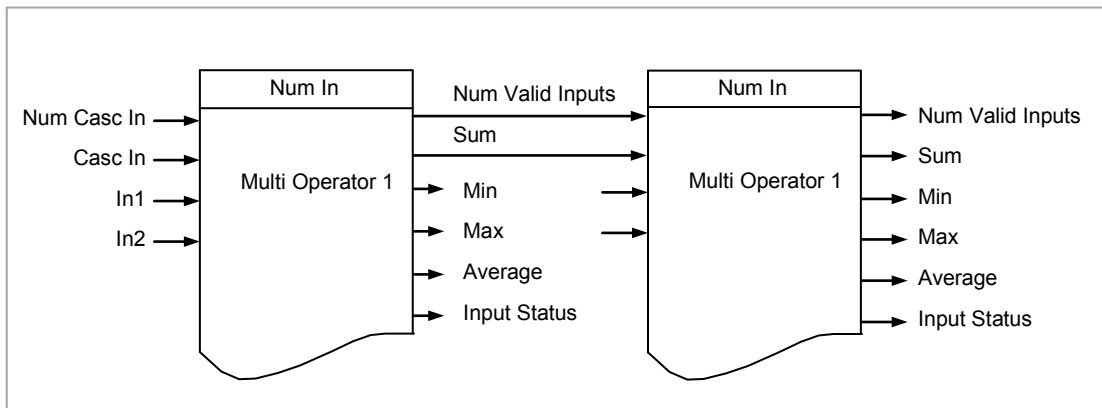

Figure 18-6: Cascaded Multi Input Operators

If 'Casc In' has 'Good' status, and 'NumCascIn' is not equal to zero, it is assumed that the block is in cascade and these values are used for calculations within the block., and the value given by 'NumCascIn' is added to 'NumValidIn'. When in cascade the sum, min, max and average outputs treat 'Casc in' as an additional input to the block. For example, if 'Casc In' is greater than any number on the rest of the inputs then its value will be output as the maximum.

### 18.5.5 Fallback Strategy for Multi Input Block

The fallback strategy may be selected in configuration mode as follows:-

#### 18.5.5.1 Clip Good

- The status of the outputs is always good
- If an output is out of range then it is clipped to limits
- If all inputs are Bad, all outputs = 0 (or clipped to limits if 0 is not within the output range)

#### 18.5.5.2 Clip Bad

- The status of all outputs is Bad if one or more of the inputs is Bad.
- If an output is out of range then it is clipped to limits and the status of that output is set to Bad
- If all inputs are Bad, all outputs = 0 and all status' are set to Bad (or clipped to limits if 0 is not within the output range)

#### 18.5.5.3 Fall Good

- The status of the outputs is always good
- If an output is out of range then it is set to the fallback value
- If all inputs are Bad, all outputs = fallback value

#### 18.5.5.4 Fall Bad

- The status of the outputs is bad if one or more of the inputs is bad
- If an output is out of range then it is set to the fallback value and the status is set to bad
- If all inputs are Bad, all outputs = fallback value and all status' are set to bad



## 18.5.6 Multi Operator Parameters

List Header – MultOp (Multi Input Operators)		Sub-headers: 1 to 2		
Name ⌚ to select	Parameter Description	Value Press ⏴ or ⏵ to change values	Default	Access Level
Num In	Number of inputs selected to use	1 to 8	2	Conf
Casc Num In	Number of cascaded inputs from the previous block	0 - 255	0	
Casc In	The cascaded input from the previous block	-99999 to 99999	0	
In1	Input 1			
In2	Input 2			
In3	Input 3			
In4	Input 4			
In5	Input 5			
In6	Input 6			
In7	Input 7			
In8	Input 8			
Units	Selected units for the I/O	None, Abs Temp, V, mV, A, mA, pH, mmHg, psi, Bar, mBar, %RH, %, mmWg, inWg, inWW, Ohms, psig, %O2, PPM, %CO2, %CP, %/sec, RelTemp, Vacuum, sec, min, hrs	None	
Res'n	Selected resolution of the outputs	XXXXX, XXXX.X, XXX.XX, XX.XXX, X.XXXX		
Out Hi Limit	Upper limit of the outputs	Between 'Out Lo Limit' and maximum display	99999	
Out Lo Limit	Lower limit of the outputs	Between 'Out Hi Limit' and minimum display	-99999	
Fallback	The state of the Output and Status parameters in case of a fault condition. This parameter could be used in conjunction with Fallback Val.	Clip Bad Clip Good Fall Bad Fall Good	Descriptions see section 18.5.5.	Conf
Fallback Val	Value to be output depending on Input Status and fallback type selected			Conf
Num Valid In	Number of inputs used in the calculated outputs			
Sum Out	Sum of the valid inputs			
Max Out	Maximum value of the valid inputs			
Min Out	Minimum value of the valid inputs			
Average Out	Average value of the valid inputs			
In Status	Status of the inputs	Good Bad		

## 19. Chapter 19 Input Characterisation

### 19.1 Input Linearisation

The Lin16 function block converts an input signal into an output PV using a series of up to 14 straight lines to characterise the conversion.

The function block provides the following behaviour.

1. The Input values must be monotonic and constantly rising.
2. To convert the MV to the PV, the algorithm will search the table of inputs until the matching segment is found. Once found, the points either side will be used to interpolate the output value.
3. If during the search, a point is found which is not above the previous (below for inverted) then the search will be terminated and the segment taken from the last good point to the extreme (In Hi-Out Hi) see following diagram.

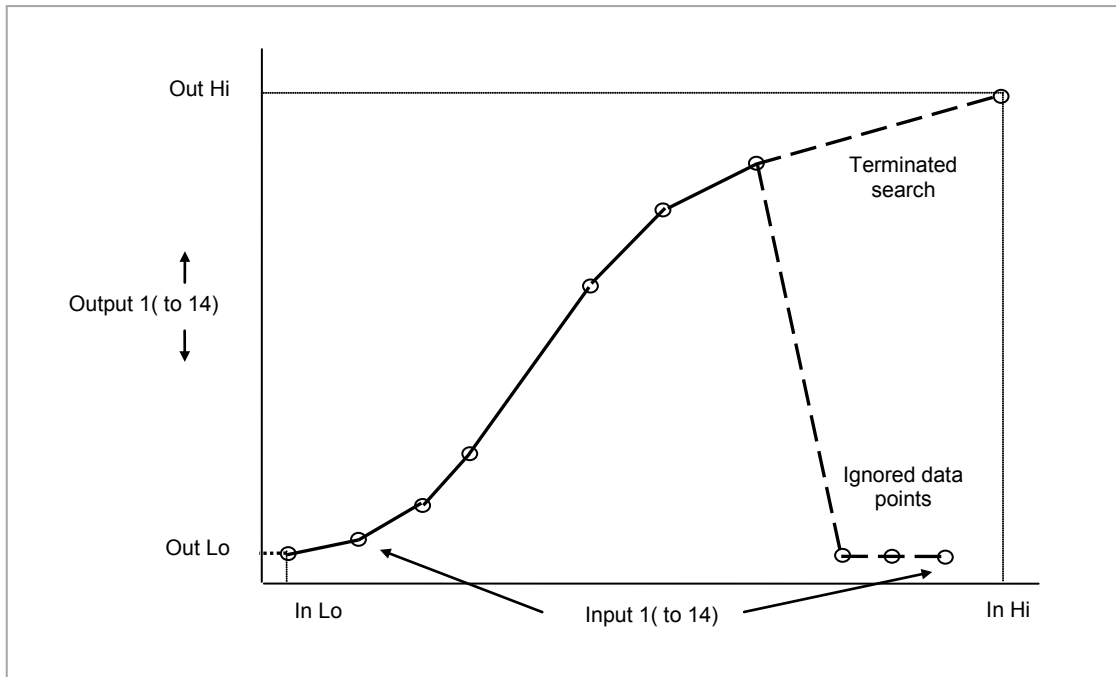

Figure 19-1: Linearisation Example



- Notes:**
1. The linearisation block works on rising inputs/rising outputs or rising inputs/falling outputs. It is not suitable for outputs which rise and fall on the same curve.
  2. Input Lo/Output Lo and Input Hi/Output Hi are entered first to define the low and high points of the curve. It is not necessary to define all 15 intermediate points if the accuracy is not required. Points not defined will be ignored and a straight line fit will apply between the last point defined and the Input Hi/Output Hi point. If the input source has a bad status (sensor break, or over-range) then the output value will also have a bad status.

1. If the input value is outside the translated range then the output status will indicate Bad, and the value will be limited to the nearest output limit.
2. The units and resolution parameters will be used for the output values. The input values resolution and units will be specified by the source of the wire.
3. If the 'Out Low' is higher than the 'Out High' then the translation will be inverted.

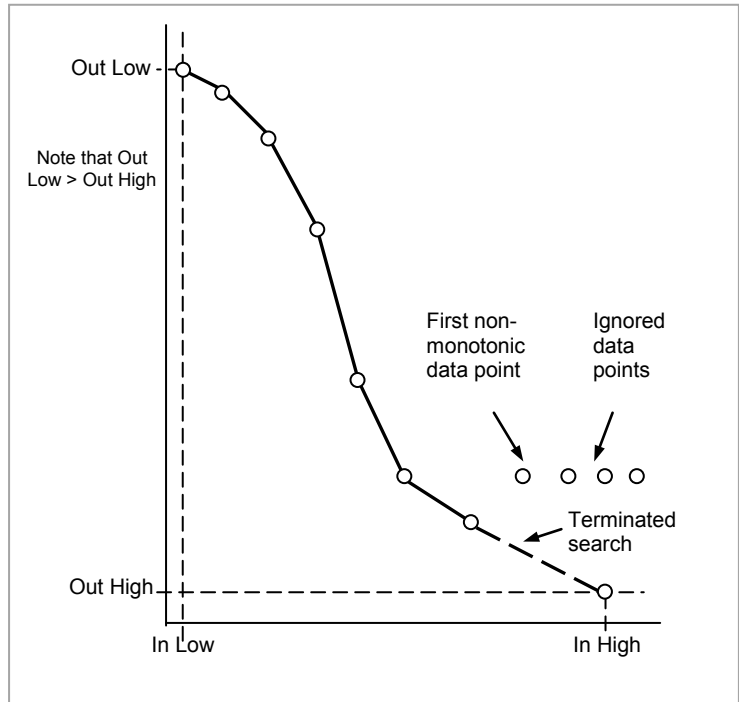

Figure 19-2: How an Inverted Curve will Terminate its search when it detects non-monotonic data

19.1.1 Compensation for Sensor Non-Linearities

The custom linearisation feature can also be used to compensate for errors in the sensor or measurement system. The intermediate points are, therefore, available in Level 1 so that known discontinuities in the curve can be calibrated out. The diagram below shows an example of the type of discontinuity which can occur in the linearisation of a temperature sensor.

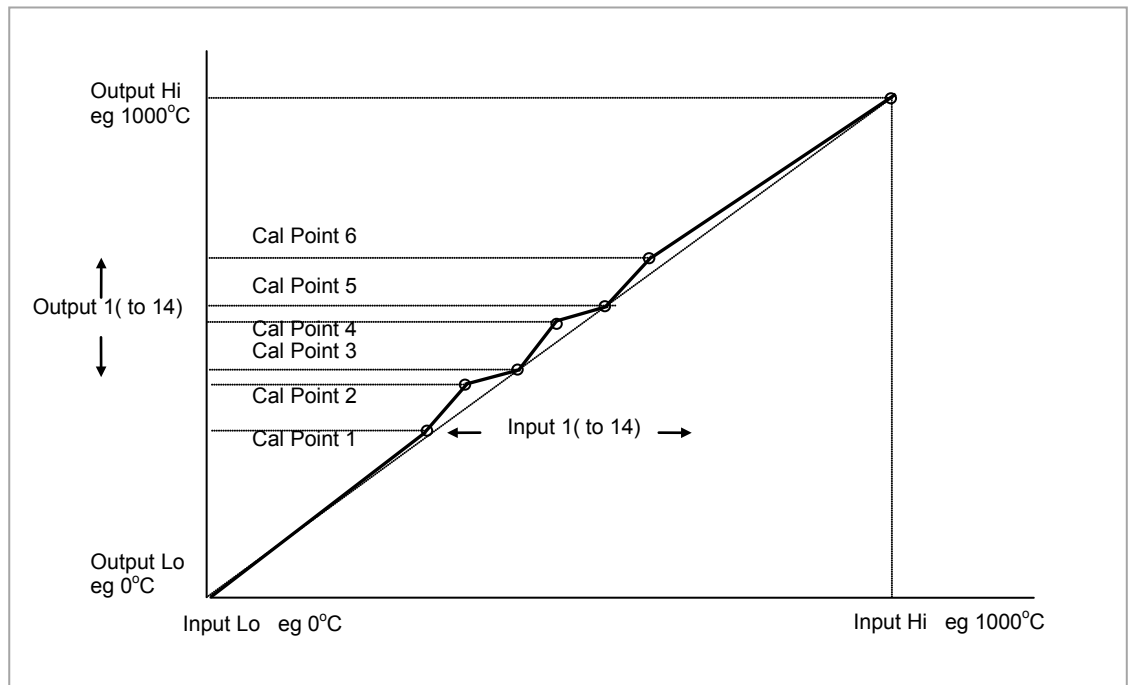





Figure 19-3: Compensation for Sensor Discontinuities

The calibration of the sensor uses the same procedure as described above. Adjust the output (displayed) value against the corresponding input value to compensate for any errors in the standard linearisation of the sensor.

**Note:**

Do not exceed the range of the instrument when choosing the compensation range. For example, whereas type K tables show mV values up to  $-270^{\circ}\text{C}$  the instrument range is limited to  $-200^{\circ}\text{C}$  so that errors may occur in the mid range if  $-200^{\circ}\text{C}$  is exceeded.

## 19.1.2 Input Linearisation Parameters

List Header – Lin16		Sub-headers: 1 to 2			
Name  to select	Parameter Description	Value Press  or  to change values		Default	Access Level
Units	Units of the linearised output	None AbsTemp V, mV, A, mA, PH, mmHg, psi, Bar, mBar, %RH, %, mmWG, inWG, inWW, Ohms, PSIG, %O2, PPM, %CO2, %CP, %/sec, RelTemp Vacuum sec, min, hrs,		None	Conf
Out Res'n	Resolution of the output value	XXXXX. XXXX.X, XXX.XX, XX.XXX, X.XXXX			Conf
Input	Input measurement to linearise. Wire to the source for the custom linearisation	Range of the source of the input			L3
Fall Type	Fallback type	Clip Bad Clip Good Fallback Bad Fallback Good Up Scale Down Scale	For an explanation, see Note 1 at the end of section 19.2.		
Fall Value	In the event of a bad status, the output may be configured to adopt the fallback value. This allows the strategy to dictate a safe output in the event of a fault being detected.	Range of the source of the input			L3 R/O
Output	The result of the linearisation				R/O
In Low	Adjust to the low input value				L3 R/O
Out Low	Adjust to correspond to the low input value				L3 R/O
In High	Adjust to the high input value				L3 R/O
Out High	Adjust to correspond to the high input value				L3 R/O
In1	Adjust to the first break point				L3 R/O
Out1	Adjust to correspond to input 1				L3
to					
In14	Adjust to the last break point				L3 R/O
Out14	Adjust to correspond to input 14				L3
Status	Status of the block. A value of zero indicates a healthy conversion.	Good Bad	Within operating limits A bad output may be caused by a bad input signal (perhaps the input is in sensor break) or an output which is out of range		R/O

 The 16 point linearisation does not force you to use all 16 points. If fewer points are required, then the curve can be terminated by setting the first unwanted value to be below the previous point. If the curve is a continuously decreasing one, then it may be terminated by setting the first unwanted point above the previous one.

## 19.2 Polynomial

List Header – Poly		Sub-headers: 1 to 2		
Name ⌚ to select	Parameter Description	Value Press ▼ or ▲ to change values	Default	Access Level
Input Lin	To select the input type. The linearisation type selects which of the instruments linearisation curves is applied to the input signal. The instrument contains a number of thermocouple and RTD linearisations as standard. In addition there are a number of custom linearisations which may be downloaded using iTools to provide linearisations of non-temperature sensors.	J , K, L, R, B, N, T, S, PL2, C, PT100, Linear, SqRoot	J	Conf L3 R/O
Units	Units of the output	None AbsTemp V, mV, A, mA, PH, mmHg, psi, Bar, mBar, %RH, %, mmWG, inWG, inWW, Ohms, PSIG, %O2, PPM, %CO2, %CP, %/sec, RelTemp Vacuum sec, min, hrs,		Conf L3 R/O
Res	Resolution of the output value	XXXXX. XXXX.X, XXX.XX, XX.XXX, X.XXXX	XXXXX	Conf L3 R/O
Input	Input Value The input to the linearisation block	Range of the input wired to		L3
Output	Output value	Between Out Low and Out High		L3 R/O
In High	Input high scale	In Low to 99999	0	L3
In Low	Input low scale	-99999 to In High	0	L3
Out High	Output high scale	Out Low to 99999	0	L3
Out Low	Output low scale	-99999 to Out High	0	L3
Fall Type	Fallback Type The fallback strategy will come into effect if the status of the input value is bad or if the input value is outside the range of input high scale and input low scale. In this case the fallback strategy may be configured as:	Clip Bad	For an explanation, see Note 1 at the end of this section	Conf
		Clip Good		
		Fall Bad		
		Fall Good		
		Upscale		
		DownScale		
Fall Value	Value to be adopted by the output in the event of Status = Bad			L3
Status	Indicates the status of the linearised output:	Good	Good indicates the value is within range and the input is not in sensor break.	L3 R/O
		Bad	Indicates the Value is out of range or the input is in sensor break. Note: This is also effected by the configured fallback strategy	

**Note 1:** 0: Clip Bad

The measurement is clipped to the limit it has exceeded and its status is set to BAD, such that any function block using this measurement can operate its own fallback strategy. For example the control loop may hold its output.

## 1: Clip Good

The measurement is clipped to the limit it has exceeded and its status is set to GOOD, such that any function block using this measurement may continue to calculate and not employ its own fallback strategy.

## 2: Fallback Bad

The measurement will adopt the configured fallback value. Which has been set by the user. In addition the status of the measured value will be set to BAD, such that any function block using this measurement can operate its own fallback strategy. For example the control loop may hold its output.

## 3: Fallback Good

The measurement will adopt the configured fallback value. Which has been set by the user. In addition the status of the measured value will be set to GOOD, such that any function block using this measurement may continue to calculate and not employ its own fallback strategy.

## 4: Up Scale

The measurement will be forced to adopt its high limit, this is like having a resistive pull up on an input circuit. In addition the status of the measurement is set to BAD, such that any function block using this measurement can operate its own fallback strategy. For example the control loop may hold its output.

## 6: Down Scale

The measurement will be forced to adopt its low limit, this is like having a resistive pull down on an input circuit. In addition the status of the measurement is set to BAD, such that any function block using this measurement can operate its own fallback strategy. For example the control loop may hold its output.

## 20. Chapter 20 Load

There are two load simulation blocks which provide styles of load for each loop. This allows an instrument configuration to be tested before connection to the process plant. In the current issue of firmware the simulated loads available are Oven and Furnace.

### 20.1 Load Parameters

List Header – Load		Sub-headers: 1 and 2			
Name ⊙ to select	Parameter Description	Value Press ▼ or ▲ to change values		Default	Access Level
Type	The type of load simulation to use. Oven is a simple load of 3 first order lags, providing a single process value for connection to the control loop. Furnace consists of 12 interactive first order lags giving a slave PV, followed by 6 interactive first order lags giving a master PV.	Oven	Simulates the characteristics of a typical oven	Oven	Conf
		Furnace	Simulates the characteristics of a typical furnace		
Res'n	The display resolution of the resultant PV Out.				Conf
Units	The Units of the resultant PV.	See section 10.3.7.			Conf
Gain	The gain of the load, the input power is multiplied by gain, before use by the load.				L3
TC1	The time constant of lag 1 in the Oven load and slave lags (1-12) of the Furnace load. The time constant has units of seconds.				L3
TC2	The time constant of lag 2/3 of the Oven load and master lags (13-18) of the furnace load.				L3
Atten (Furnace load only)	Attenuation Between PV1 and PV2 Stages. Used in the advanced furnace load and defines an attenuation factor between the slave and master lags				L3
Ch 2 Gain	Defines the relative gain when cooling is requested, applied to the input power when the power requested is < 0.				L3
PVFault	The load function block provides 2 PV outputs. Sensor fault can be used to generate a fault condition on these PV's such that the bad status is passed along a wire to be consumed by another block such as the loop. The sensor fault can be configured as →	None			L3
		PVOut1	No fault conditions. Fault on the first output (slave).		
		PVOut2	Fault on the second output (master).		
		Both	A fault on first and second outputs (master and slave).		
PV Out1	First Process Value The PV in Process Value an Oven load or the Slave PV in a furnace load.				L3 R/O
PV Out2 (Furnace load only)	Second Process Value Second process value, lagged from PVOut1, used as a cascade master input. The Master PV in the Furnace load.				L3 R/O
LoopOP CH1	Loop output channel 1 input. The output of the loop as wired to the load simulation, this is the power requested of the load. This can be used as the heat demand.				L3
LoopOP CH2	Loop output channel 2 input. The output of the loop as wired to the load simulation, this is the power requested of the load. This can be used as the cool demand.				L3
Noise	Noise Added to PV This is used to make the PV of the load appear noisy, and hence more like a real measurement.	Off 1 to 99999	The amount of noise is specified in engineering units.	Off	L3

List Header – Load		Sub-headers: 1 and 2		
Name ⊙ to select	Parameter Description	Value Press ▼ or ▲ to change values	Default	Access Level
Offset	Process offset Used to configure an offset in the process. In a temperature application this could represent the ambient operating temperature of the plant.			L3



## 21. Chapter 21 Control Loop Set Up

Software version 1 contains one loop of control. From version 2 onwards two loops are available. Each loop contains two outputs, Channel 1 and Channel 2, each of which can be configured for PID, On/Off or Valve Position (bounded or unbounded) control. In a temperature control loop Channel 1 is normally configured for heating and Channel 2 for cooling. Descriptions given in this chapter mainly refer to temperature control but generally also apply to other process loops.

### 21.1 What is a Control Loop?

An example of a heat only temperature control loop is shown below:-

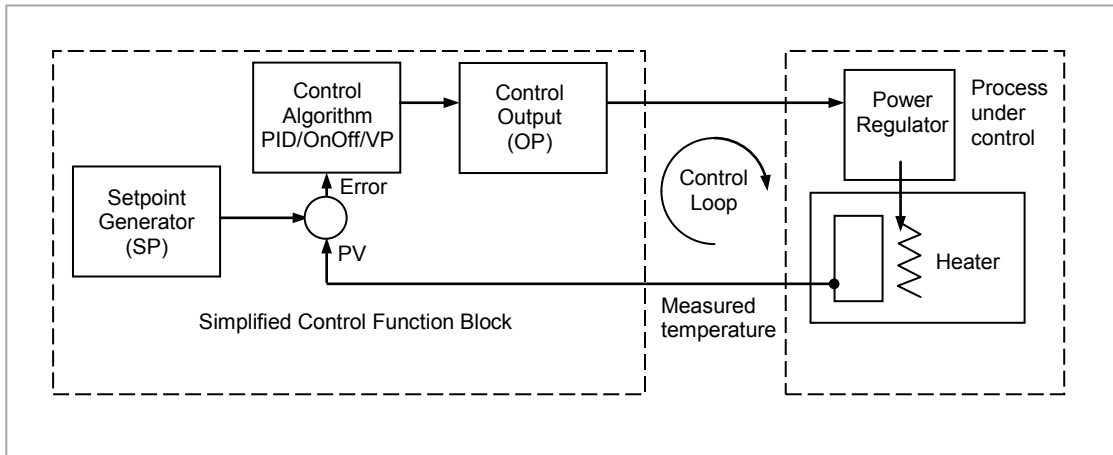

Figure 21-1: Single Loop Single Channel

The actual measured temperature, or process variable (**PV**), is connected to the input of the controller. The PV is compared with a setpoint (**SP**) (or required temperature). If there is an error between the set and measured temperature the controller calculates an output value to call for heating or cooling. The calculation depends on the process being controlled. In this controller it is possible to select between a **PID, On/Off, Boundless or Bounded Valve Position** algorithm. The output(s) from the controller (**OP**) are connected to devices on the plant which cause the heating (or cooling) demand to be adjusted resulting in a change in PV which, in turn, is measured by the sensor. This is referred to as closed loop control.

### 21.2 Control Loop Function Blocks

The control loop consists of a number of function blocks. The parameters associated with each function block are presented in sub-headings. Each sub-heading is listed under the overall page header '**Lp-**' (**Lp1** for the first loop and **LP2** for the second loop).

The function blocks, described in this chapter are:-

Sub-heading	Typical Parameters	Section Number
Main	Overview of the main parameters such as Auto/Manual select, current PV, current output demand, selected setpoint value and working setpoint value	21.3
Setup	To configure control type for each channel of the selected loop	21.4
Tune	To set up and run the Auto-tune function	21.6
PID	To set up 3 term control parameters	21.5
SP	To select and adjust different setpoints, setpoint limits, rate of change of setpoint	21.7
OP	To set up output parameters such as limits, sensor break conditions	21.8
Diag	Diagnostic parameters	21.9

## 21.3 Main Function Block

The Main function block provides an overview of parameters used by the overall control loop. It allows:-

- Auto or Manual operation to be selected
- To stop the loop from controlling for commissioning purposes
- To hold the integral action.
- Read PV and SP values

Parameters can be soft wired as part of a control strategy.

### 21.3.1 Loop Parameters - Main

A summary of the parameters which provide an overview of loop 1 (Lp1) or loop 2 (Lp2) are listed in the following table:-

List Header – Lp1 or Lp2		Sub-header: Main			
Name ⊙ to select	Parameter Description	Value Press ▼ or ▲ to change values		Default	Access Level
AutoMan See also section 21.3.2.	To select Auto or Manual operation. This performs the same function as the Auto/Manual button described in section 2.6.	Auto	Automatic (closed loop) operation	Auto	L3
		Man	Manual (output power adjusted by the user) operation		
PV	The process variable input value. This is typically wired from an analogue input.	Range of the input source			L3
Inhibit	Used to stop the loop controlling. If enabled the loop will stop control and the output of the loop will be set to the 'Safe' output value. 'Safe' is a parameter found in the Lp1 (or2) OP list. If output rate limit is set the output will go to 'Safe' at the rate limit. On exit from inhibit the transfer will be bumpless.  If tracking is configured (see sections 21.7.4 and 21.7.5.) Inhibit will override tracking.  Inhibit may be wired to an external source	No Yes	Inhibit disabled Inhibit enabled	No	L3
Target SP	The value of setpoint at which the control loop is aiming. It may come from a number of different sources, such as internal SP and remote SP.	Between setpoint limits			L3
WSP	The current value of the setpoint being used by the control loop. It may come from a number of different sources, such as internal SP and Remote SP. The working setpoint is always read-only as it is derived from other sources.	Between setpoint limits			R/O
Work OP	The actual output of the loop before it is split into the channel 1 and channel 2 outputs.				R/O
IntHold	Freeze the integral term at its current value. See also section 21.5.8	No Yes	Integral hold disabled Integral hold enabled	No	L3

### 21.3.2 Auto/Manual

If On/Off control is configured the output power may be edited by the user but will only allow the power to be set to +100%, 0% or -100%. This equates to heat ON/cool OFF, heat OFF/cool OFF, heat OFF/cool ON.

For PID control the output may be edited between +100% and -100% (if cool is configured). The true output value is subject to limiting and output rate limit.

For valve position control the raise and lower buttons in manual will directly control the raise and lower relay (or triac) outputs. From digital communications it is possible to control the valve by sending nudge commands. A single nudge command will move the valve by 1 minimum on time. In manual mode the natural state will be rest.

If sensor break occurs while the controller is in automatic the controller will output the sensor break output power. However, the user can now switch to manual control. In this case manual will become active and the user can edit the output power. On leaving manual, i.e. returning to automatic control, the controller will again check for sensor break.

If autotune is enabled while in manual mode, the autotune will remain in a reset state such that when the user puts the controller into automatic control the autotune will start.

## 21.4 Loop Set Up Function Block

Loop Set Up configures the type of control required for each channel.

### 21.4.1 Types of Control Loop

Three types of control loop may be configured. These are On/Off control, PID control or control of motorised valves.

#### 21.4.1.1 On/Off Control

On/Off control is the simplest means of control and simply turns heating power on when the PV is below setpoint and off when it is above setpoint. As a consequence, On/Off control leads to oscillation of the process variable. This oscillation can affect the quality of the final product and may be used on non-critical processes. A degree of hysteresis must be set in On/Off control if the operation of the switching device is to be reduced and relay chatter is to be avoided.

If cooling is used, cooling power is turned on when the PV is above setpoint and off when it is below.

It is suitable for controlling switching devices such as relays, contactors, triacs or digital (logic) devices.

#### 21.4.1.2 PID Control

PID, also referred to as 'Three Term Control', is an algorithm which continuously adjusts the output, according to a set of rules, to compensate for changes in the process variable. It provides more stable control but the parameters need to be set up to match the characteristics of the process under control.

The three terms are:

P Proportional band

I Integral time

D Derivative time

The output from the controller is the sum of the contributions from these three terms. The combined output is a function of the magnitude and duration of the error signal, and the rate of change of the process value.

It is possible to turn off integral and derivative terms and control on proportional only (P), proportional plus integral (PI) or proportional plus derivative (PD).

PI control might be used, for example, when the sensor measuring an oven temperature is susceptible to noise or other electrical interference where derivative action could cause the heater power to fluctuate wildly.

PD control may be used, for example, on servo mechanisms.

In addition to the three terms described above, there are other parameters which determine how well the control loop performs. These include Cutback terms, Relative Cool Gain, Manual Reset and are described in the following sections.

**21.4.1.3 Motorised Valve Control**

This algorithm is designed specifically for positioning motorised valves. It operates in boundless (sometimes called Valve Positioning Unbounded) or bounded mode.

**Boundless VP control (VPU)** does not require a position feedback potentiometer to operate. It is a velocity mode algorithm which directly controls the direction and velocity of the movement of the valve in order to minimise the error between the setpoint and the PV. It uses triac or relay outputs to drive the valve motor.

☺ a potentiometer may be used with boundless mode but it is used solely for indication of the actual valve position and is not used as part of the control algorithm.

**Bounded VP (VPB) control** requires a feedback potentiometer as part of the control algorithm.

The control is performed by delivering a 'raise' pulse, a 'lower' pulse or no pulse in response to the control demand signal via relay or triac outputs.

**21.4.1.4 Motorised Valve Control in Manual mode**

Bounded VP controls in manual mode by the fact that the inner positional loop is still running against the potentiometer feedback, so it is operating as a position loop.

In boundless mode the algorithm is a velocity mode positioner. When manual is selected the algorithm predicts where the valve will move to based on the edit of the manual power. Effectively, when the raise or lower key is pressed, +100% or -100% velocity is used for the duration of the key press and the raise or lower output is turned on. In boundless mode it is essential that the motor travel time is set correctly in order for the integral time to calculate correctly. Motor travel time is defined as **valve** fully open – **valve** fully closed - it is not necessarily the time printed on the motor since, if mechanical stops have been set on the motor, the travel time of the actual valve may be different. Also, if the travel time for the valve is set correctly, the position indicated on the controller will fairly accurately match the actual valve position.

Every time the valve is driven to its end stops the algorithm is reset to 0% or 100% to compensate for any changes which may occur due to wear in linkages or other mechanical parts.

This technique makes boundless VP look like a positional loop in manual even though it is not. This enables combinations of heating and cooling e.g. PID heat, VPU cool and have the manual mode work as expected.

**21.4.1.5 Motorised Valve Output Connections**

The loop output which has been configured as valve position can be wired to the Logic IO (LA and LB) or to a Dual Output (Relay, Logic or Triac) module. Only one IO Type needs to be configured in the dual IO output since the second will assume the opposite type. For example, if Loop 1 Channel 1 output is wired to Logic IO LA and the IO Type is configured as Valve Raise then IO Type for Logic IO LB will be Valve Lower as shown below.

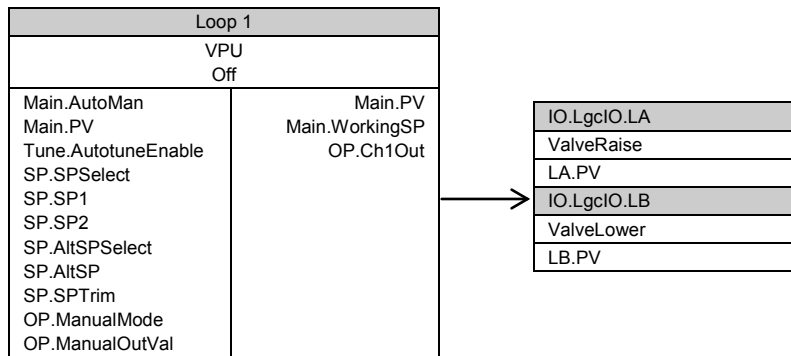

### 21.4.2 Loop Parameters - Set up

A summary of the parameters used to configure the type of control are listed in the following table:-

List Header – Lp1 or Lp2		Sub-header: Setup			
Name ⌚ to select	Parameter Description	Value Press ⏴ or ⏵ to change values		Default	Access Level
Ch1 Control Ch2 Control. See also section 21.4.1.	Selects the channel 1/2 control algorithm. Different algorithms may be selected for channels 1 and 2. In temperature control applications, Ch1 is usually heating, Ch2 is cooling	Off	Channel turned off	As ordered	Conf L3 R/O
		OnOff	On/off control		
		PID	3 term or PID control		
		VPU	Valve position unbounded		
		VPB	Valve position bounded		
Control Act	Sets the direction of control, i.e. reverse or direct acting	Rev	Reverse acting. The output increases when the PV is below SP. This is the usual setting for heating control.	Rev	Conf L3 R/O
		Dir	Direct acting. The output increases when the PV is above SP. This is the usual setting for cooling control		
PB Units See also section 21.5.2	Sets the presentation style of the Proportional band.	Eng	Engineering units e.g. C or F	Eng	Conf L3 R/O
		Percent	Per cent of loop span (Range Hi - Range Lo)		
Deriv Type	Selects whether the derivative acts only on PV changes or on Error (either PV or Setpoint changes).	PV	Only changes in PV cause changes to the derivative output. Generally used for process systems particularly using valve control where it reduces wear on valve mechanics.	PV	Conf L3 R/O
		Error	Changes to either PV or SP will cause a derivative output. Derivative on error should be used with a programmer since it tends to reduce ramp overshoot. It is also generally an advantage to use derivative on error for temperature control systems to give a quick response to small setpoint changes.		
The above two parameters do not appear if either Ch1 or Ch2 are configured for Off or OnOff control					
Loop Name	Customised name for the loop	Configured using iTools see section 27.17			R/O

## 21.5 PID Function Block

The PID function block consists of the following parameters:-

### 21.5.1 Loop Parameters - PID

A summary of the parameters used to optimize the control are listed in the following table:-

List Header – Lp1 or Lp2		Sub-header: PID			
Name ⌚ to select	Parameter Description	Value Press ▼ or ▲ to change values		Default	Access Level
Sched Type	To choose the type of gain scheduling.	Off	Gain scheduling not active	Off	L3
		Set	The PID set can be selected by the operator.		
		SP	The transfer between one set and the next depends on the value of the setpoint		
		PV	The transfer between one set and the next depends on the value of the process variable		
		Error	The transfer between one set and the next depends on the value of the error		
		OP	The transfer between one set and the next depends on the value of the output		
		Rem	The transfer between one set and the next depends on the value of the remote input		
Num Sets	Selects the number of PID sets in the gain scheduling. This allows the lists to be reduced if the process does not require all three PID sets.	1 to 3		1	L3
Remote Input	This parameter only appears when 'Sched Type' = 'Rem'.	Range units			L3
Active Set	Currently working set.	Set1 Set2 Set3		Set1	R/O
Boundary 1-2	Sets the level at which PID set 1 changes to PID set 2.	Range units The 'Boundary' parameter only applies when 'Sched Type' = 'SP', 'PV', 'Error', 'OP' or 'Rem'			L3
Boundary 2-3	Sets the level at which PID set 2 changes to PID set 3.				
The above 6 parameters are associated with Gain Scheduling described further in section 21.5.11.					
PB/PB2/PB3	Proportional band Set1/Set2/Set3. The proportional term, in display units or %, delivers an output which is proportional to the size of the error signal. See also section 21.5.2.	0.0 to 9999.9 (0.0 is not a practical setting)	Engineering units or %	20	L3
Ti/Ti2/Ti3	Integral time constant Set1/Set2/Set3. Removes steady state control offsets by ramping the output up or down in proportion to the amplitude and duration of the error signal. See also section 21.5.3.	Off or 1 to 99999	Units = seconds Off = Integral action disabled	360	L3

List Header – Lp1 or Lp2		Sub-header: PID			
Name Ⓞ to select	Parameter Description	Value Press ▼ or ▲ to change values		Default	Access Level
Td/Td2/Td3	Derivative time constant Set1/Set2/Set3 Determines how strongly the controller will react to the rate of change in the measured value. It is used to control overshoot and undershoot and to restore the PV rapidly if there is a sudden change in demand. See also section 21.5.4.	Off or 1 to 99999	Units = seconds Off = Derivative action disabled	60	L3
R2G/R2G2/ R2G3	Relative cool gain Set1/Set2/Set3. Only present if cooling has been configured. Sets the cooling proportional band, which compensates for differences between heating power gain and cooling power gain. See also section 21.5.5.	0.1 to 10.0		1.0	L3
CBH/CBH2/ CBH3	Cutback high Set1/Set2/Set3. The number of display units, above setpoint, at which the controller output will be forced to 0% or -100% (OP min), in order to modify undershoot on cool down. See also section 21.5.6.	Auto or 0.1 to 9999.9	Auto = 3*PB	Auto	L3
CBL/CBL2/ CBL3	Cutback low Set1/Set2/Set3. The number of display units, below setpoint, at which the controller output will be forced to 100% (OP max), in order to modify overshoot on heat up. See also section 21.5.6.				
MR/MR2/MR3	Manual reset Set1/Set2/Set3. Used to remove PV offsets from the setpoint. Manual reset introduces a fixed additional power level to the output. This is the power required to eliminate the steady state error from proportional only control. The manual reset is applied in place of the integral component when integral time is set to Off. See also section 21.5.7.	0.0 to 100.0	%	0.0	L3
LBT/LBT2/LBT3	Loop break time Set1/Set2/Set3 See also section 21.5.10.	Off or 1 to 99999	Units = seconds	100	L3
OPHi/2/3	Output high limit for each set	+100	Limits between 'OPLo' and 100	100	L3
OPLo/2/3	Output low limit for each set	-100	Limits between 'OPHi' and -100	-100	L3



**Note:** If the control type is set to On/Off, only LBT is shown in the PID list..



### 21.5.2 Proportional Band

The proportional band (PB), or gain, delivers an output which is proportional to the size of the error signal. It is the range over which the output power is continuously adjustable in a linear fashion from 0% to 100% (for a heat only controller). Below the proportional band the output is full on (100%), above the proportional band the output is full off (0%) as shown in Figure 21-2.

The width of the proportional band determines the magnitude of the response to the error. If it too narrow (high gain) the system oscillates by being over responsive. If it is too wide (low gain) the control is sluggish. The ideal situation is when the proportional band is as narrow as possible without causing oscillation.

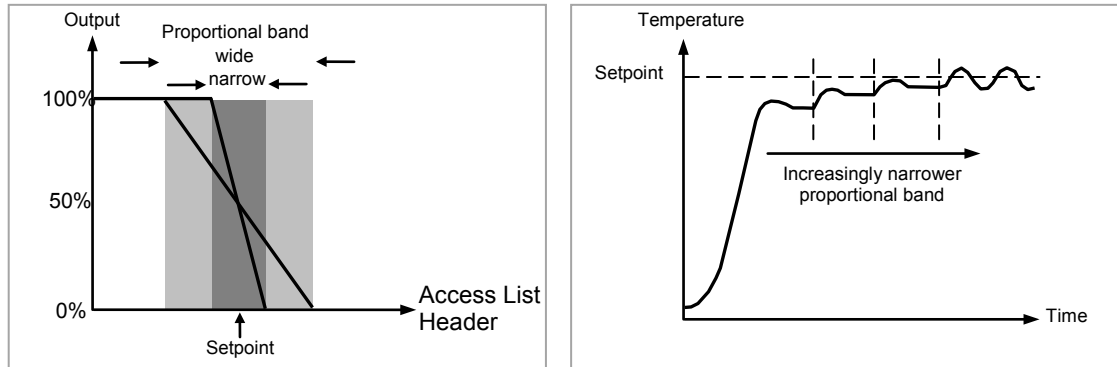

**Figure 21-2: Proportional Action**

Figure 21-2 also shows the effect of narrowing proportional band to the point of oscillation. A wide proportional band results in straight line control but with an appreciable initial error between setpoint and actual temperature. As the band is narrowed the temperature gets closer to setpoint until finally becoming unstable.

The proportional band may be set in engineering units or as a percentage of the controller range.

### 21.5.3 Integral Term

In a proportional only controller, an error between setpoint and PV must exist for the controller to deliver power. Integral is used to achieve **zero** steady state control error.

The integral term slowly shifts the output level as a result of an error between setpoint and measured value. If the measured value is below setpoint the integral action gradually increases the output in an attempt to correct the error. If it is above setpoint integral action gradually decreases the output or increases the cooling power to correct the error.

Figure 21-3 shows the result of introducing integral action.

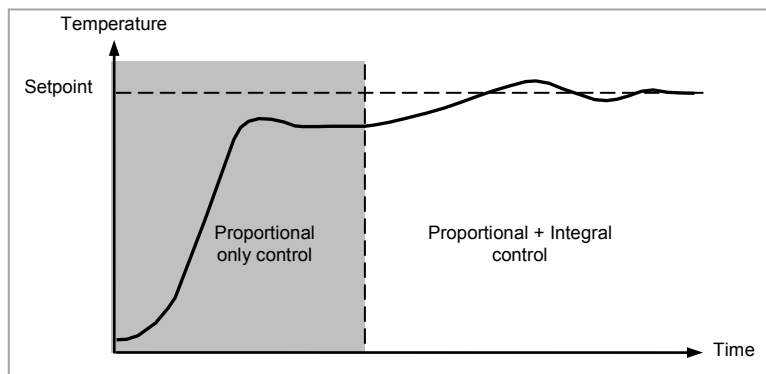
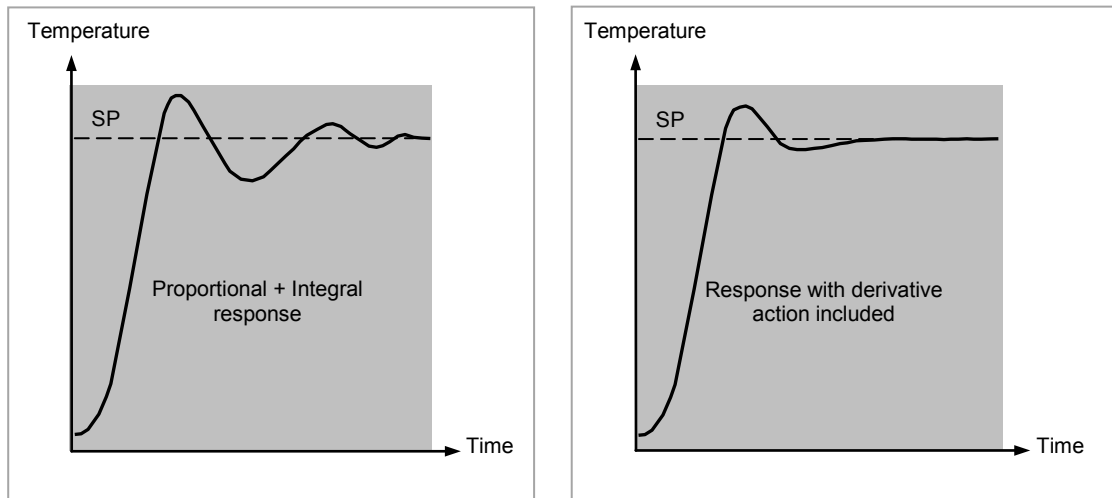

**Figure 21-3: Proportional + Integral Control**

The units for the integral term are measured in time (1 to 99999 seconds in 3500 controllers). The longer the integral time constant, the more slowly the output is shifted and results in a sluggish response. Too small an integral time will cause the process to overshoot and even oscillate. The integral action may be disabled by setting its value to Off.

### 21.5.4 Derivative Term

Derivative action, or rate, provides a sudden shift in output as a result of a rapid change in error, whether or not this is caused by PV alone (derivative on PV) or on SP changes as well (derivative on error selection) – see also section 21.4.2. If the measured value falls quickly derivative provides a large change in output in an attempt to correct the perturbation before it goes too far. It is most beneficial in recovering from small perturbations.



**Figure 21-4: Proportional + Integral + Derivative Action**

The derivative modifies the output to reduce the rate of change of error. It reacts to changes in the PV by changing the output to remove the transient. Increasing the derivative time will reduce the settling time of the loop after a transient change.

Derivative is often mistakenly associated with overshoot inhibition rather than transient response. In fact, derivative should not be used to curb overshoot on start up since this will inevitably degrade the steady state performance of the system. Overshoot inhibition is best left to the approach control parameters, High and Low Cutback, section 21.5.6.

Derivative is generally used to increase the stability of the loop, however, there are situations where derivative may be the cause of instability. For example, if the PV is noisy, then derivative can amplify that noise and cause excessive output changes, in these situations it is often better to disable the derivative and re-tune the loop.

If set to Off(0), no derivative action will be applied.

Derivative can be calculated on change of PV or change of Error. If configured on error, then changes in the setpoint will be transmitted to the output. For applications such as furnace temperature control, it is common practice to select Derivative on PV to prevent thermal shock caused by a sudden change of output as a result of a change in setpoint.

### 21.5.5 Relative Cool Gain

The gain of channel 2 control output, relative to the channel 1 control output.

Relative Ch2 Gain compensates for the different quantities of power available to heat, as opposed to that available to cool, a process. For example, water cooling applications might require a relative cool gain of 0.25 because cooling is 4 times greater than the heating process at the operating temperature.

(This parameter is normally set automatically when an Autotune is performed).

### 21.5.6 High and Low Cutback

Cutback high '**CBH**' and Cutback low '**CBL**' are values that modify the amount of overshoot, or undershoot, that occurs during large step changes in PV (for example, under start-up conditions). They are independent of the PID terms which means that the PID terms can be set for optimal steady state response and the cutback parameters used to modify any overshoot which may be present.

Cutback involves moving the proportional band towards the cutback point nearest the measured value whenever the latter is outside the proportional band and the power is saturated (at 0 or 100% for a heat only controller). The proportional band moves downscale to the lower cutback point and waits for the measured value to enter it. It then escorts the measured value with full PID control to the setpoint. In some cases it can cause a 'dip' in the measured value as it approaches setpoint as shown in Figure 21-5 but generally decreases the time needed to bring the process into operation.

The action described above is reversed for falling temperature.

If cutback is set to Auto the cutback values are automatically configured to  $3 \times \text{PB}$ .

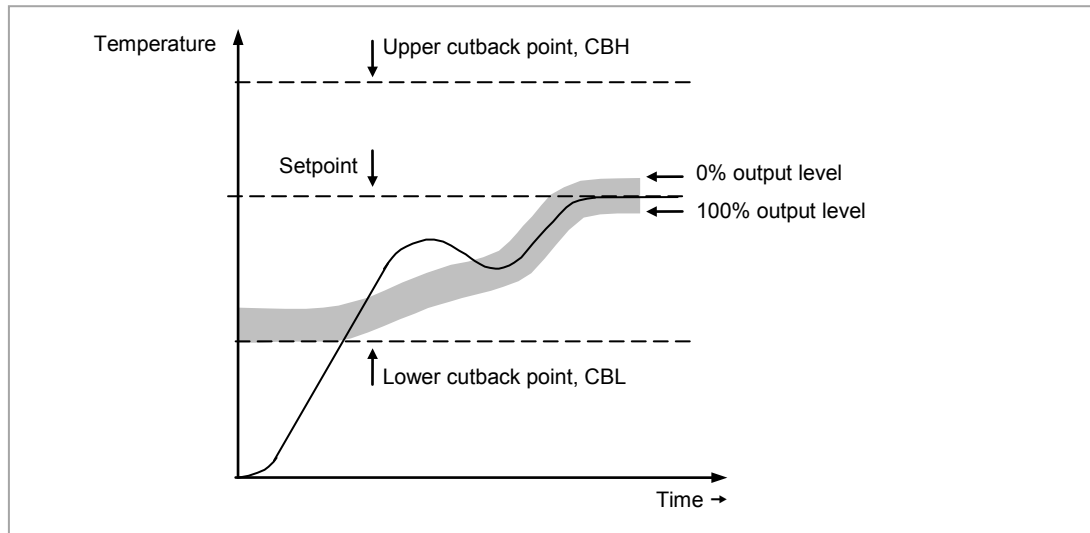

Figure 21-5: High and Low Cutback

### 21.5.7 Manual Reset

In a full three-term controller (that is, a PID controller), the integral term automatically removes the steady state error from the setpoint. If the controller is set as a PD controller, the integral term will be set to 'OFF'. Under these conditions the measured value may not settle precisely at setpoint. The Manual Reset parameter (MR) represents the value of the power output that will be delivered when the error is zero. You must set this value manually in order to remove the steady state error.

### 21.5.8 Integral Hold

If enabled, the integral component of the PID calculation will be frozen. Hence, it will hold at its current value but will not integrate any disturbances in the plant. Essentially this is equivalent to switching into PD control with a manual reset value preconfigured.

It may be used, for example, in a situation where the loop is expected to open – it may be necessary to turn heaters off for a short period or switch into manual at low power. In this case it may be an advantage to wire it to a digital input which activates when the heaters are turned off. When the heaters are switched on again the integral is at its previous value minimising overshoot.

### 21.5.9 Integral De-bump

This is a feature included in the controller which is not accessible to the user. When changing from Manual to Auto control the integral component is forced to:

the output value – the proportional component – the derivative component ( $I = OP - P - D$ ).

This ensures that no change occurs in output at the point of switch over, and is termed '**Bumpless Transfer**'. The output power will then gradually change in accordance with the demand from the PID algorithm. Bumpless transfer also occurs when changing from Auto to Manual control. At the point of changeover the output power remains the same as the demand in the auto state. It can then be raised or lowered by the operator from this level.

### 21.5.10 Loop Break

The loop is considered to be broken if the PV does not respond to a change in the output in a given time. Since the time of response will vary from process to process the **Loop Break Time (LBT – PID list)** parameter allows a time to be set before a **Loop Break Alarm (Lp Break - Diag list)** is initiated.

The Loop Break Alarm attempts to detect loss of restoring action in the control loop by checking the control output, the process value and its rate of change. This is not to be confused with Load Failure and Partial Load Failure. The loop break algorithm is purely software detection.

Occurrence of a loop break causes the Loop Break Alarm parameter to be set. It does not affect the control action unless it is wired (in software or hardware) to affect the control specifically.

It is assumed that, so long as the requested output power is within the output power limits of a control loop, the loop is operating in linear control and is therefore not in a loop break condition.

However, if the output becomes saturated then the loop is operating outside its linear control region.

Furthermore if the output remains saturated at the same output power for a significant duration, then this could indicate a fault in the control loop. The source of the loop break is not important, but the loss of control could be catastrophic.

Since the worst case time constant for a given load is usually known, a worst case time can be calculated over which the load should have responded with a minimum movement in temperature.

By performing this calculation the corresponding rate of approach towards setpoint can be used to determine if the loop can no longer control at the chosen setpoint. If the PV was drifting away from the setpoint or approaching the setpoint at a rate less than that calculated, the loop break condition would be met.

If an autotune is performed the loop break time is automatically set to  $T_i^2$  for a PI or PID loop alternatively  $12 \cdot T_d$  for a PD loop. For an On/Off controller loop break detection is also based on loop break time as  $0.1 \cdot \text{SPAN}$  where  $\text{SPAN} = \text{Range High} - \text{Range Low}$ . Therefore, if the output is at limit and the PV has not moved by  $0.1 \cdot \text{SPAN}$  in the loop break time a loop break will occur.

If the loop break time is 0(off) the loop break time is not set.

If the output is in saturation and the PV has not moved by  $>0.5 \cdot P_b$  in the loop break time, a loop break condition is considered to have occurred.

### 21.5.11 Gain Scheduling

In some processes the tuned PID set may be very different at low temperatures from that at high temperatures particularly in control systems where the response to the cooling power is significantly different from that of the heating power. Gain scheduling allows a number of PID sets to be stored and provides automatic transfer of control between one set of PID values and another. In the case of the 3500 the maximum number of sets is three which means that two boundaries are provided to select when the next PID set is used. When a boundary is exceeded the next PID set is selected bumplessly. Hysteresis is used to stop scheduling oscillation at the boundaries.

Gain scheduling is basically a look up table which can be selected using different strategies or types. Auto tune will tune to the active scheduled PID set.

The following Gain Scheduled types are offered using the parameter 'Sched Type':

Set	The PID set can be selected by the operator. It is possible to use soft wiring to control the selection of the gain sets. This could be linked to the programmer segment, changing the PID settings for individual segments or it could be wired to a digital input so that the working PID set can be set remotely.
SP	The transfer between one set and the next depends on the value of the SP
PV	The transfer between one set and the next depends on the value of the PV
Error	The transfer between one set and the next depends on the value of the error
OP	The transfer between one set and the next depends on the value of the OP demand
Rem	A remote parameter may be wired into the Scheduler, the PID set is then selected based on the value of this input. An example, might be to automatically change feedforward trim limits in a cascade loop.

The 3500 controller has a maximum of three sets of PID values. The parameter 'Num Sets' allows the number of sets to be limited to one, two or three.

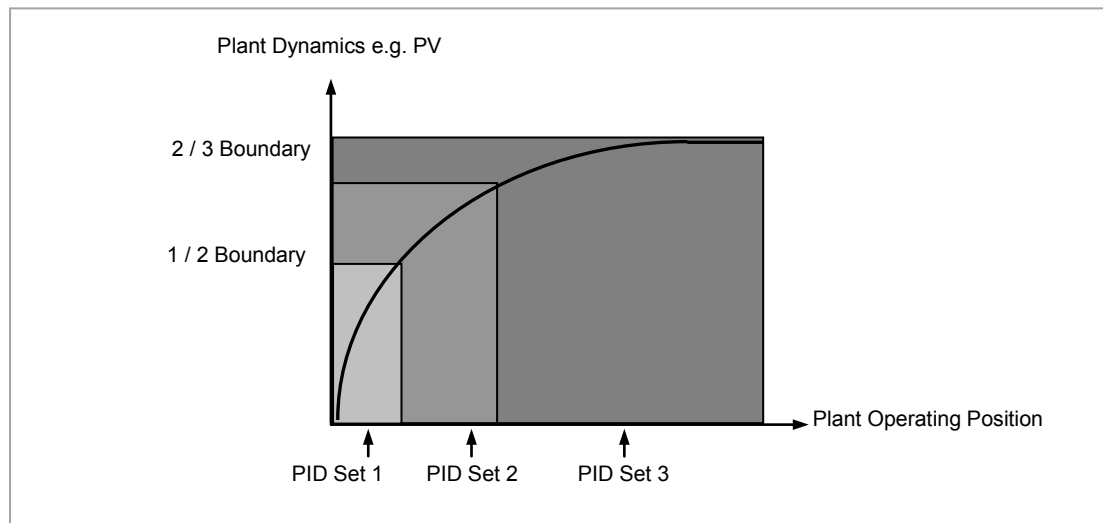

Figure 21-6: Gain Scheduling over a Wide range of Operating Variable

## 21.6 Tuning Function Block

Tuning involves setting the following parameters.

Proportional Band 'PB', Integral Time 'Ti', Derivative Time 'Td', Cutback High 'CBH', Cutback Low 'CBL', and Relative Cool Gain 'R2G' (applicable to heat/cool systems only).

The controller is shipped with these parameters set to default values. In many cases the default values will give adequate stable straight line control, however, the response of the loop may not be ideal. Because the process characteristics are fixed by the design of the process it is necessary to adjust the control parameters in the controller to achieve best control. To determine the optimum values for any particular loop or process it is necessary to carry out a procedure called loop tuning. If significant changes are later made to the process which affect the way in which it responds it may be necessary to retune the loop.

Users have the choice of tuning the loop automatically or manually. Both procedures require the loop to oscillate and both are described in the following sections.

### 21.6.1 Loop Response

If we ignore the situation of loop oscillation, there are three categories of loop performance:

**Under Damped** - In this situation the terms are set to prevent oscillation but do lead to an overshoot of the Process Value followed by decaying oscillation to finally settle at the Setpoint. This type of response can give a minimum time to Setpoint but overshoot may cause problems in certain situations and the loop may be sensitive to sudden changes in Process Value. This will result in further decaying oscillations before settling once again.

**Critically Damped** - This represents an ideal situation where overshoot to small step changes does not occur and the process responds to changes in a controlled, non oscillatory manner.

**Over Damped** - In this situation the loop responds in a controlled but sluggish manner which will result in a loop performance which is non ideal and unnecessarily slow.

The balancing of the P, I and D terms depends totally upon the nature of the process to be controlled.

In a plastics extruder, for example, a barrel zone will have a different response to a die, casting roll, drive loop, thickness control loop or pressure loop. In order to achieve the best performance from an extrusion line all loop tuning parameters must be set to their optimum values.

Gain scheduling is provided to allow specific PID settings to be applied at the different operating points of the process.

### 21.6.2 Initial Settings

In addition to the tuning parameters listed in section 21.6 above, there are a number of other parameters which can have an effect on the way in which the loop responds. Ensure that these are set before either manual or automatic tuning is initiated. Parameters include, but are not limited to:-

**Setpoint.** Before starting a tune the loop conditions should be set as closely as practicable to the actual conditions which will be met in normal operation. For example, in a furnace or oven application a representative load should be included, an extruder should be running, etc.

**Heat/Cool Limits.** The minimum and maximum power delivered to the process may be limited by the parameters '**Output Lo**' and '**Output Hi**' both of which are found in the Loop OP list, section 21.8. For a heat only controller the default values are 0 and 100%. For a heat/cool controller the defaults are -100 and 100%. Although it is expected that most processes will be designed to work between these limits there may be instances where it is desirable to limit the power delivered to the process. For example, if driving a 220V heater from a 240V source the heat limit may be set 80% to ensure that the heater does not dissipate more than its maximum power.

**Remote Output Limits.** '**RemOPL**' and '**RemOPHi**' (Loop OP List). If these parameters are used they should be set within the Heat/Cool Limits above.

**Heat/Cool Deadband.** In controllers fitted with a second (cool) channel a parameter '**Ch2 DeadB**' is also available in the Loop OP list, section 21.8, which sets the distance between the heat and cool proportional bands. The default value is 0% which means that heating will turn off at the same time as cooling turns on. The deadband may be set to ensure that there is no possibility of the heat and cool channels being on together, particularly when cycling output stages are installed.

**Minimum On Time.** If either or both of the output channels is fitted with a relay, triac or logic output, the parameter '**Min OnTime**' will appear in the relevant output list (Logic IO List, AA Relay Output List or Relay, Triac or Logic Output Module List). This is the cycling time for a time proportioning output and should be set correctly before tuning is started.

**Input Filter Time Constant.** The parameter '**Filter Time**' is found in the PV Input List.

**Output Rate limit.** Output rate limit is active during tuning and may affect the tuning results. The parameter '**Rate**' is found in the Loop OP List.

**Valve Travel Time.** If the output is a motor valve positioner the '**Ch1 TravelT**' and '**Ch2 TravelT**' (Loop OP List) should be set as described in section 21.8.1.

#### Other Considerations

- If a process includes adjacent interactive zones, each zone should be tuned independently.
- It is always better to start a tune when the PV and setpoint are far apart. This allows start up conditions to be measured and cutback values to be calculated more accurately.
- If the two loops in a 3500 controller are connected for cascade control, the inner loop may be tuned automatically but the outer should be tuned manually.
- In a programmer/controller tuning should only be attempted during dwell periods and not during ramp stages. If a programmer/controller is tuned automatically put the controller into Hold during each dwell period whilst autotune is active. It may be worth noting that tuning, carried out in dwell periods which are at different extremes of temperature may give different results owing to non linearity of heating (or cooling). This may provide a convenient way to establish values for Gain Scheduling (see section 21.5.11).

☺ If an auto tune is initiated there are two further parameters which need to be set. These are 'High Output' and 'Low Output'. These are found in the 'Tune' List, see also section 21.6.4.

### 21.6.3 Automatic Tuning

Auto Tune is a tool which is used to set the control terms as close as possible to match the characteristics of the process.

It uses the 'one-shot' tuner which works by switching the output on and off to induce an oscillation in the process value. For this reason the auto tune process should be done off line but using load conditions as close as possible to those to be found in practice. From the amplitude and period of the oscillation, it calculates the control parameter values listed in the table below.

Proportional Band ' <b>PB</b> '	
Integral Time ' <b>Ti</b> '	If ' <b>Ti</b> ' and/or ' <b>Td</b> ' is set to OFF, because you wish to use PI, PD or P only control, these terms will remain off after an autotune.
Derivative Time ' <b>Td</b> '	
Cutback High ' <b>CBH</b> '	If CBH and/or CBL is set to ' <b>Auto</b> ' these terms will remain at Auto after an autotune, i.e. 3*PB. For autotune to set the cutback values, CBH and CBL must be set to a value (other than Auto) before autotune is started. Autotune will never return cutback values which are less than 1.6*PB.
Cutback Low ' <b>CBL</b> '	
Relative Cool Gain ' <b>R2G</b> '	R2G is only calculated if the controller is configured as heat/cool. Following an autotune, ' <b>R2G</b> ' is always limited to between 0.1 and 10. If the calculated value is outside this limit a 'Tune Fail' alarm is given. In software releases up to and including 2.30, if the calculated value is outside this limit, R2G remains at its previous value but all other tuning parameters are changed.
Loop Break Time ' <b>LBT</b> '	Following an autotune, ' <b>LBT</b> ' is set to 2*Ti (assuming the integral time is not set to OFF). If ' <b>Ti</b> ' is set to OFF then ' <b>LBT</b> ' is set to 12*Td.

The autotune sequence for different conditions is described in sections 21.6.10 to 21.6.12.

### 21.6.4 Loop Parameters - Auto-Tune

A summary of the Autotune parameters is listed in the following table:-

List Header – Lp1 or Lp2		Sub-header: Tune			
Name ⌚ to select	Parameter Description	Value Press ⏴ or ⏵ to change values		Default	Access Level
Tune R2G  R2G applies only to Ch1/Ch2 (heat/cool) control.	Defines the type of relative cooling gain tuning for the loop.  For further information, please refer to section 21.6.14 'Well Lagged Systems'.	Standard	Tunes the relative cooling gain of the loop using the standard R2G tuning algorithm.	Standard	
		R2GPD	If the process is heavily lagged, this setting should be used.		
		Off	R2G is not calculated automatically. Enter the value manually as described in section 21.6.16.		
Enable	To start auto-tune	Off	Auto-tune not running. If Off is selected during a tune, tuning will stop.	Off	L3
		On	Auto-tune running		
High Output	Set high and low limits to be imposed when auto-tune is running	Between Output Hi and Output Lo overall limits set in the OP block. Max and Min limits -100% to 100%.			L3
Low Output					
State	Reads the progress of auto-tune.	Off	Not running	Off	L3 R/O
		Ready			
		Running	In progress		
		Complete	Auto-tune completed successfully		
		Timeout	Error conditions, see section 21.6.13.		
		TI_Limit			
		R2G_Limit			
Stage	Progress of auto-tune	Settling	Displayed during the first minute	Off	L3 R/O
		To SP	Heat (or cool) output on		
		Wait min	Power output off		
		Wait max	Power output on		
		Timeout	See section 21.6.13		
		TI Limit			
		R2G Limit			
Stage Time	Time in current tune stage	0 to 99999 seconds			L3 R/O
Diagnostic	Tuning diagnostics	This parameter is for internal use only			L3



### 21.6.5 To Auto Tune a Loop - Initial Settings







Set parameters listed in section 21.6.2.

'Output Hi' and 'Output Lo' ('OP' List section 21.8.1) set the overall output limits. These limits apply at all times during tuning and during normal operation.

Set 'High Output' and 'Low Output' ('Tune' list section 21.6.4). These parameters set the output power limits during Autotune.

- ☺ The 'tighter' power limit will always apply. For example if 'High Output' is set to 80% and 'Output Hi' is set to 70% then the output power will be limited to 70%.
- ☺ The measured value *must* oscillate to some degree for the tuner to be able to calculate values. The limits must be set to allow oscillation about the setpoint.

### 21.6.6 To Start Autotune

- a. Select operator level 3. Auto tune cannot be performed in Configuration level or when the loop is in Manual mode.
- b. Press  to select the 'Lp1' (or 'Lp2') list header,
- c. Press  or  to select the 'Tune' sub-header
- d. Press  to select 'Enable'
- e. Press  or  to select 'On'

A One-shot Tune can be performed at any time, but normally it is performed only once during the initial commissioning of the process. However, if the process under control subsequently becomes unstable (because its characteristics have changed), it may be necessary to tune again for the new conditions.

The auto tune algorithm reacts in different ways depending on the initial conditions of the plant. The explanations given in this section are for the following conditions:-

1. Initial PV is below the setpoint and, therefore, approaches the setpoint from below for a heat/cool control loop
  2. Initial PV is below the setpoint and, therefore, approaches the setpoint from below for a heat only control loop
  3. Initial PV is at the same value as the setpoint. That is, within 0.3% of the range of the controller if 'PB Units' (Setup list) is set to 'Percent' or  $\pm 1$  engineering unit (1 in 1000) if the 'PB Units' is set to 'Eng'. Range is defined as 'Range Hi' – 'Range Lo' for process inputs or the range defined in section 7.2.1 for temperature inputs.
- ☺ If the PV is just outside the range stated above the autotune will attempt a tune from above or below SP.

### 21.6.7 Autotune and Sensor Break

When the controller is autotuning and sensor break occurs, the autotune will abort and the controller will output the sensor break output power 'Sbrk OP' set up in the OP List. Autotune must be re-started when the sensor break condition is no longer present.

### 21.6.8 Autotune and Inhibit or Manual

If the Loop Inhibit is asserted or the controller is put into Manual Mode, any tune in progress will be aborted and will need to be re-started once the condition has been removed. Note that it is not possible to start an autotune sequence if the loop is inhibited or in Manual control.

### 21.6.9 Autotune and Gain Scheduling

When gain scheduling is enabled and an autotune is performed, the calculated PID values will be written into the PID set that is active on completion of the tune. Therefore, the user may tune within the boundaries of a set and the values will be written into the appropriate PID set. However, if the boundaries are close, since the range of the loop is not large, then, at the completion of the tune, it cannot be guaranteed that the PID values will be written to the correct set particularly if the schedule type is PV or OP. In this situation the scheduler ('Sched Type') should be switched to 'Set' and the 'Active Set' chosen manually.

**21.6.10 Autotune from Below SP – Heat/Cool**

The point at which Automatic tuning is performed (Tune Control Point) is designed to operate just below the setpoint at which the process is normally expected to operate (Target Setpoint). This is to ensure that the process is not significantly overheated or overcooled. The Tune Control Point is calculated as follows:-

$$\text{Tune Control Point} = \text{Initial PV} + 0.75(\text{Target Setpoint} - \text{Initial PV}).$$

The Initial PV is the PV measured at 'B' (after a 1 minute settling period)

Examples: If Target Setpoint = 500°C and Initial PV = 20°C, then the Tune Control Point will be 380°C.

If Target Setpoint = 500°C and Initial PV = 400°C, then the Tune Control Point will be 475°C.

This is because the overshoot is likely to be less as the process temperature is already getting close to the target setpoint.

The sequence of operation for a tune from below setpoint for a heat/cool control loop is described below:-

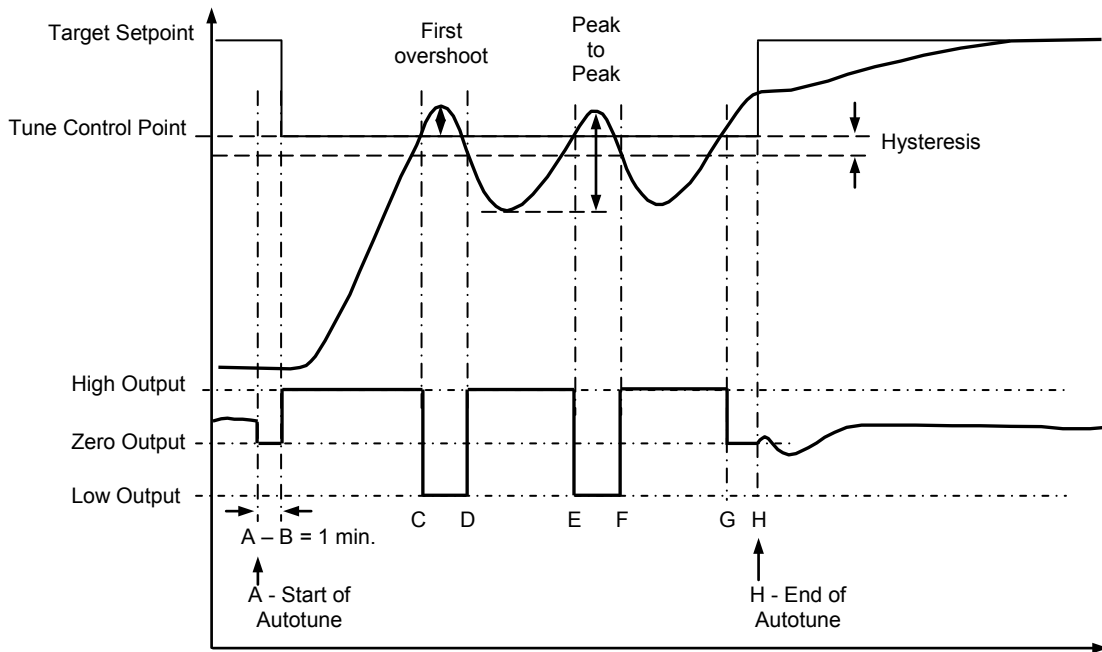

Figure 21-7: Autotune - Heat/Cool Process

Period	Action
A	Start of Autotune
A to B	Both heating and cooling power remains off for a period of 1 minute to allow the algorithm to establish steady state conditions.
B to D	First heat/cool cycle to establish first overshoot. 'CBL' is calculated on the basis of the size of this overshoot (assuming it is not set to Auto in the initial conditions).
B to F	Two cycles of oscillation are produced from which the peak to peak response and the true period of oscillation are measured. PID terms are calculated
F to G	An extra heat stage is provided and all heating and cooling power is turned off at G allowing the plant to respond naturally. Measurements made during this period allow the relative cool gain 'R2G' to be calculated. 'CBH' is calculated from CBL*R2G.
H	Autotune is turned off at and the process is allowed to control at the target setpoint using the new control terms.

Autotune can also occur when the initial PV is above SP. The sequence is the same as tuning from below setpoint except that the sequence begins with full cooling applied at 'B' after the first one minute settling time.

### 21.6.11 Autotune From Below SP – Heat Only

The sequence of operation for a heat only loop is the same as that previously described for a heat/cool loop except that the sequence ends at 'F' since there is no need to calculate 'R2G'.

At 'F' autotune is turned off and the process is allowed to control using the new control terms.

Relative cool gain, 'R2G', is set to 1.0 for heat only processes.

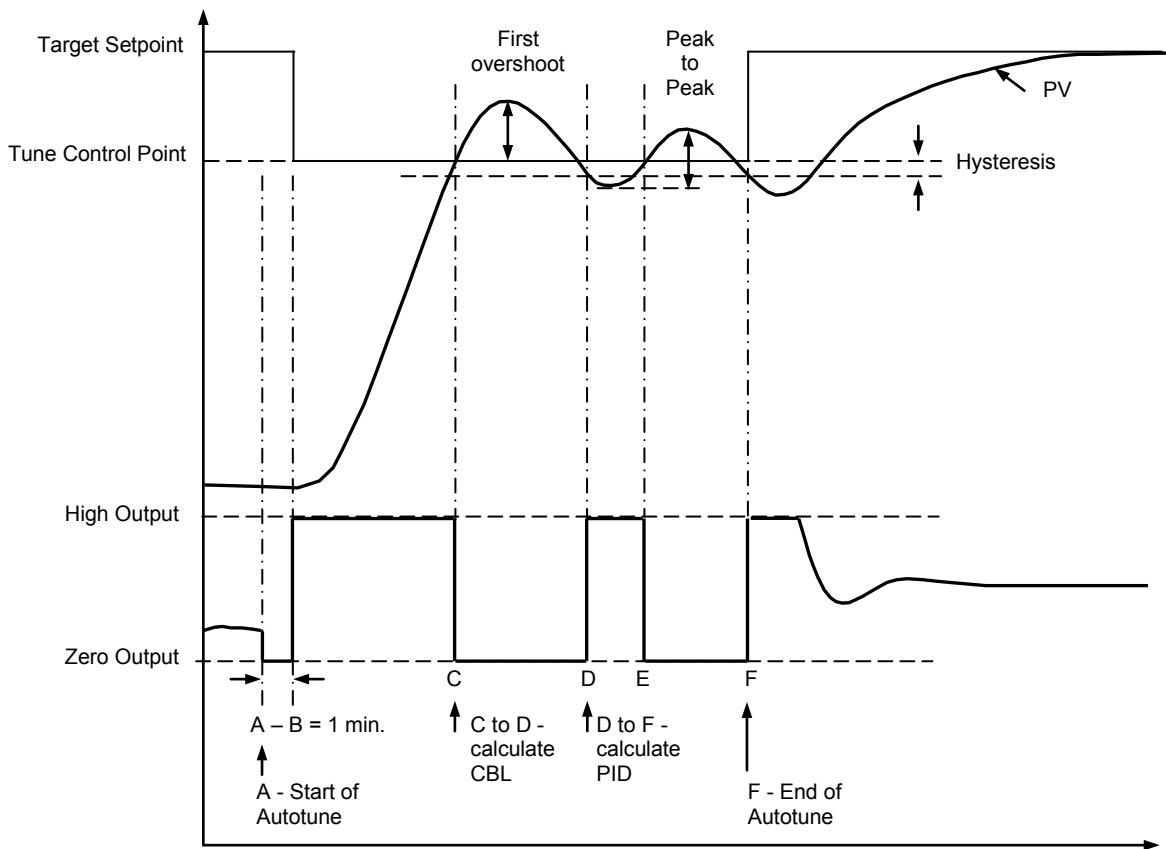

Figure 21-8: Autotune from below SP – Heat Only

For a tune from below setpoint 'CBL' is calculated on the basis of the size of the overshoot (assuming it was not set to Auto in the initial conditions). CBH is then set to the same value as CBL.



**Note:** As with the heat/cool case, Autotune can also occur when the initial PV is above SP. The sequence is the same as tuning from below setpoint except that the sequence starts with natural cooling applied at 'B' after the first one minute settling time. In this case CBH is calculated – CBL is then set to the same value as CBH.

**21.6.12 Autotune at Setpoint – Heat/Cool**

It is sometimes necessary to tune at the actual setpoint being used. This is allowable in 3500 series controllers and the sequence of operation is described below.

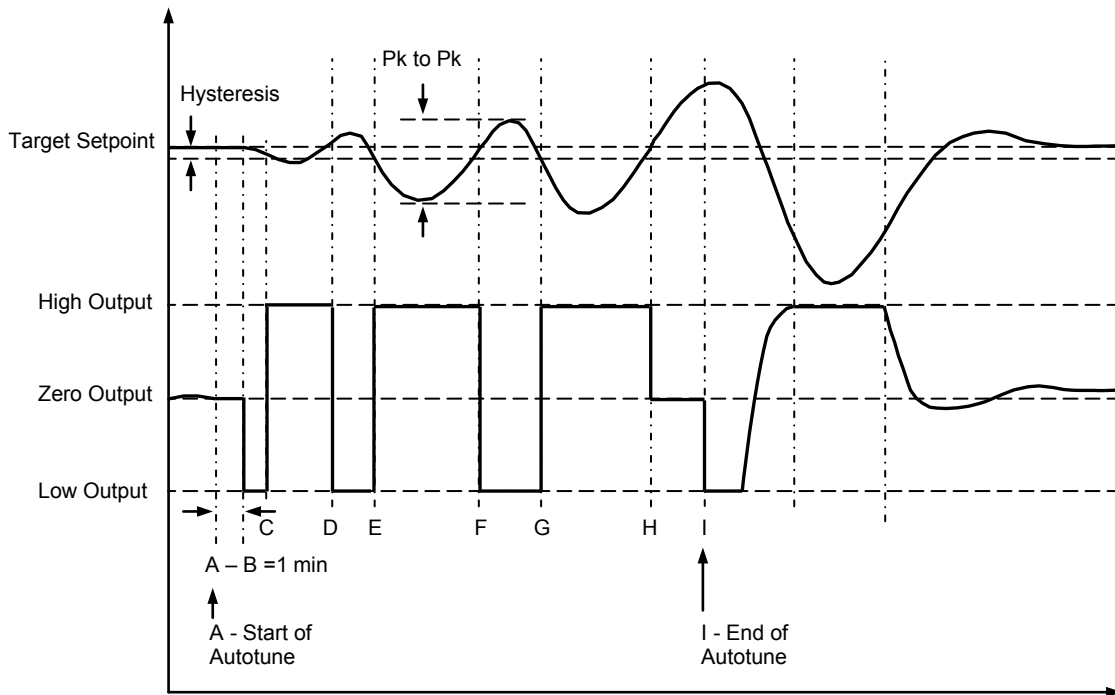

**Figure 21-9: Autotune at Setpoint**

Period	Action
A	Start of Autotune. A test is done at the <b>start of autotune</b> to establish the conditions for a tune at setpoint. The conditions are that the SP must remain within 0.3% of the range of the controller if ' <b>PB Units</b> ' (Setup list) is set to ' <b>Percent</b> '. If ' <b>PBUnits</b> ' is set to ' <b>Eng</b> ' then the SP must remain within $\pm 1$ engineering unit (1 in 1000). Range is defined as 'Range Hi' – 'Range Lo' for process inputs or the range defined in section 7.2.1 for temperature inputs.
A to B	The output is <b>frozen at the current value</b> for one minute and the conditions are continuously monitored during this period. If the conditions are met during this period autotune at setpoint is initiated at B. If at any time during this period the PV drifts outside the condition limits a tune at setpoint is abandoned. Tuning is then resumed as a tune from above or below setpoint depending on which way the PV has drifted. Since the loop is already at setpoint there is no need to calculate a Tune Control Setpoint – the loop is forced to oscillate around the Target Setpoint
C to G	Initiate oscillation - the process is forced to oscillate by switching the output between the output limits. From this the <b>period of oscillation</b> and the <b>peak to peak</b> response is measured. <b>PID</b> terms are calculated
G to H	An extra heat stage is provided and all heating and cooling power is turned off at H allowing the plant to respond naturally. Measurements made during this period allow the relative cool gain ' <b>R2G</b> ' to be calculated.
I	Autotune is turned off and the process is allowed to control at the target setpoint using the new control terms.

For a tune at setpoint autotune does not calculate cutback since there was no initial start up response to the application of heating or cooling. The exception is that the cutback values will never be returned less than  $1.6 \cdot PB$ .

### 21.6.13 Failure Modes

The conditions for performing an autotune are monitored by the parameter 'State'. If autotune is not successful error conditions are read by this parameter as follows:-

- |           |   |
|-----------|---|
| Timeout   | This will occur if any one stage is not completed within one hour. It could be due to the loop being open or not responding to the demands from the controller. Very heavily lagged systems may produce a timeout if the cooling rate is very slow.   |
| TI Limit  | This will be displayed if Autotune calculates a value for the integral term greater than the maximum allowable integral setting i.e. 99999 seconds. This may indicate that the loop is not responding or that the tune is taking too long.  |
| R2G Limit | The calculated value of R2G is outside the range 0.1 and 10.0. In versions up to and including V2.3, R2G is set to 0.1 but all other PID parameters are updated.<br>R2G limit may occur if the gain difference between heating and cooling is too large. This could also occur if the controller is configured for heat/cool but the cooling medium is turned off or not working correctly. It could similarly occur if the cooling medium is on but heating is off or not working correctly. |

### 21.6.14 Relative Cool Gain in Well Lagged Processes

In the majority of processes Relative Cool Gain R2G is calculated by the autotune algorithm as described in the previous sections – section 21.6.10 in particular.

There are occasions, however, where an alternative algorithm may be preferred. These are processes which are heavily lagged, where the heat loss to ambient is very small so that natural cooling is extremely slow, and certain high order plants, those that need derivative, Td. This algorithm is known as R2GPD algorithm and has been added to controllers from firmware version V3.30.

The type of algorithm is selected using the parameter 'Tune R2G' found in the Auto-Tune list, section 21.6.4. The choices are:-

- Standard** This is the default as described in section 21.6.10 and is suitable for use on most processes. The benefit of this algorithm is that it is relatively quick. However, in the type of process described in the previous paragraph, it can produce values which are not ideal. These values are generally identified by R2G equal to or very close to 0.1.
- R2GPD** If the process is known to be heavily lagged or produces values such as those above then R2GPD should be selected. This algorithm extends the autotune period by putting the controller into proportional plus derivative mode (PD) and uses the output power demand value during this period to determine the Relative Cool Gain.
- Off** The automatic calculation of Relative Cool Gain can be turned off and the value entered manually as described in section 21.6.16.

#### 21.6.14.1 When Tune R2G = R2GPD, Autotune from below setpoint is described below.

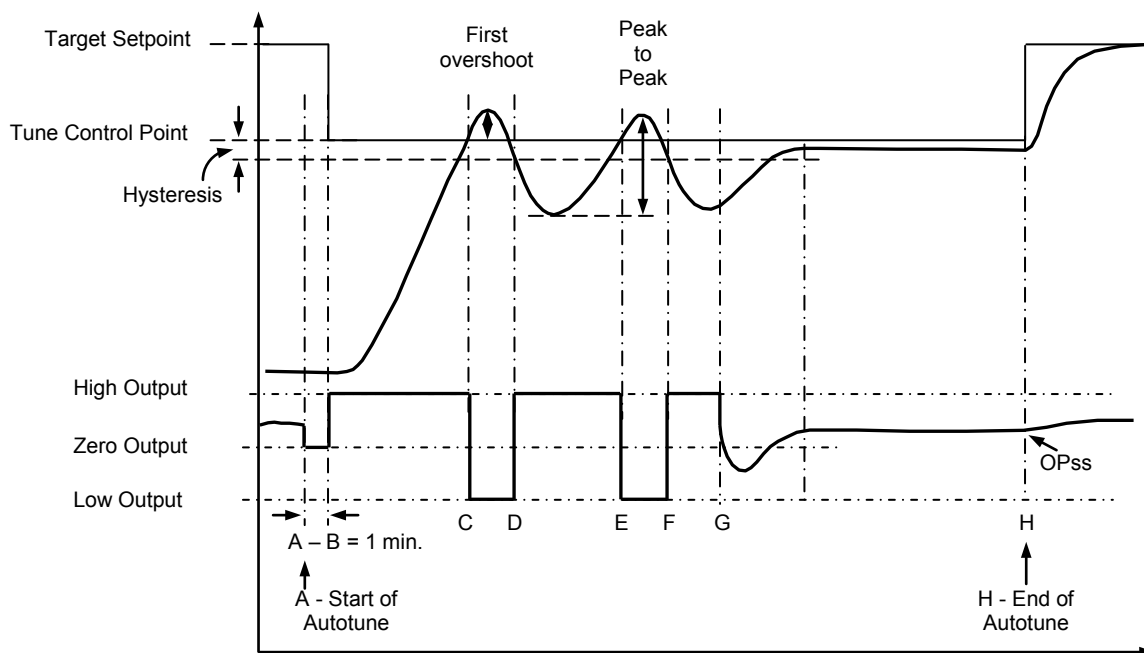

Periods A-F are largely unchanged from the 'Standard' algorithm, section 21.6.10, with the following exception:

- Changing the Target Setpoint during period A-B will not change the tuning setpoint.

Period F-H is replaced as follows:-

- F to G Heat is applied for a period (F-G) of half the last heat cycle (D-E) to compensate for the last cool cycle
- G to H This is a period in which the controller is put into PD control.  
The values of proportional term and derivative time for this period of PD control are determined by the algorithm.
- H OPss is the output demand value at the end of this period and is used in the determination of R2G.

### 21.6.15 Manual Tuning

If for any reason automatic tuning gives unsatisfactory results, you can tune the controller manually. There are a number of standard methods for manual tuning. The one described here is the Ziegler-Nichols method.

Adjust the setpoint to its normal running conditions (it is assumed this will be above the PV so that heat only is applied)

Set the Integral Time 'Ti' and the Derivative Time 'Td' to 'OFF'.

Set High Cutback 'CBH' and Low Cutback 'CBL' to 'Auto'.

Ignore the fact that the PV may not settle precisely at the setpoint.

If the PV is stable, reduce the proportional band so that the PV just starts to oscillate. Allow enough time between each adjustment for the loop to stabilise. Make a note of the proportional band value 'PB' and the period of oscillation 'T'. If PV is already oscillating measure the period of oscillation 'T', then increase the proportional band until it just stops oscillating. Make a note of the value of the proportional band at this point.

Set the proportional band, integral time and derivative time parameter values according to the calculations given in the table below:-

Type of control	Proportional band (PB)	Integral time (Ti) seconds	Derivative time (Td) seconds
Proportional only	2xPB	OFF	OFF
P + I control	2.2xPB	0.8xT	OFF
P + I + D control	1.7xPB	0.5xT	0.12xT

### 21.6.16 Manually Setting Relative Cool Gain

If the controller is fitted with a cool channel this should be enabled before the PID values calculated from the table in section 21.6.15 are entered.

Observe the oscillation waveform and adjust R2G until a symmetrical waveform is observed.

Then enter the values from the table.

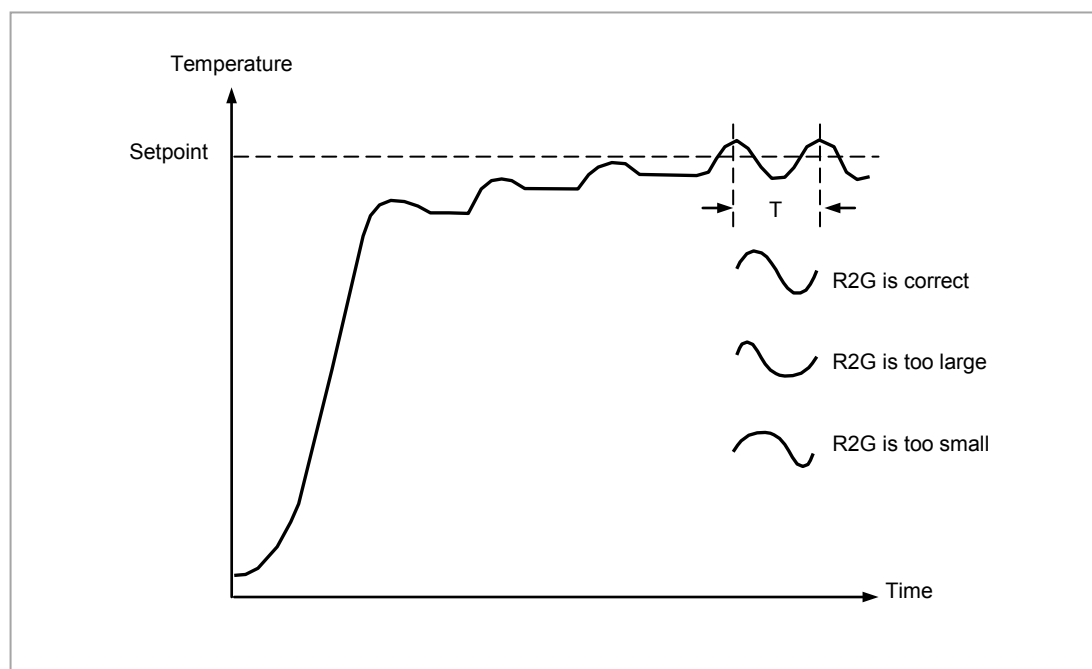

Figure 21-10: Setting Relative Cool Gain

### 21.6.17 Manually Setting the Cutback Values

Enter the PID terms calculated from the table in section 21.6.15 before setting cutback values.

The above procedure sets up the parameters for optimum steady state control. If unacceptable levels of overshoot or undershoot occur during start-up, or for large step changes in PV, then manually set the cutback parameters.

Proceed as follows:

Initially set the cutback values to one proportional bandwidth converted into display units. This can be calculated by taking the value in percentage that has been installed into the parameter 'PB' and entering it into the following formula:-

$PB/100 * \text{Span of controller} = \text{Cutback High and Cutback Low}$

For example, if PB = 10% and the span of the controller is 0 -1200°C, then

Cutback High and Low =  $10/100 * 1200 = 120$

If overshoot is observed following the correct settings of the PID terms increase the value of 'CBL' by the value of the overshoot in display units. If undershoot is observed increase the value of the parameter 'CBH' by the value of the undershoot in display units.

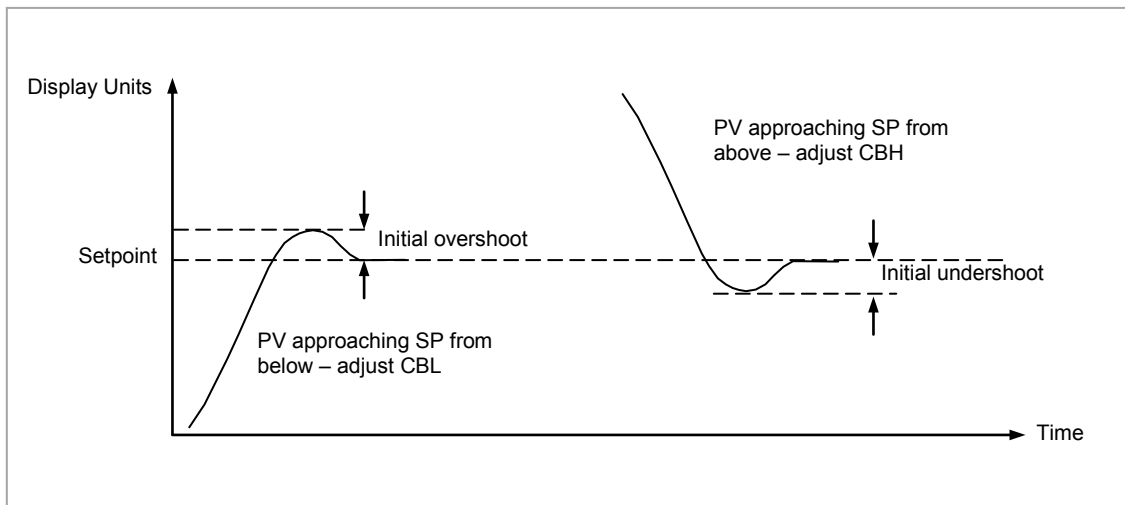

Figure 21-11: Manual Setting of Cutback



### 21.7 Setpoint Function Block

The controller setpoint is the **Working Setpoint** which may be sourced from a number of alternatives. This is the value ultimately used to control the process variable in a loop.

The working setpoint may be derived from:-

1. SP1 or SP2, both of which are manually set by the user and can be switched into use by an external signal or through the user interface.
2. From an external (remote) analogue source
3. The output of a programmer function block. This will, therefore, vary in accordance with the program in use.

The setpoint function block also provides the facility to limit the rate of change of the setpoint before it is applied to the control algorithm. It will also provide upper and lower limits. These are defined as setpoint limits, 'SP HighLim' and 'SP LowLim', for the local setpoints and instrument range high and low for other setpoint sources. All setpoints are ultimately subject to a limit of 'Range Hi' and 'Range Lo'.

User configurable methods for tracking are available, such that the transfer between setpoints and between operational modes will not cause a bump in the setpoint.

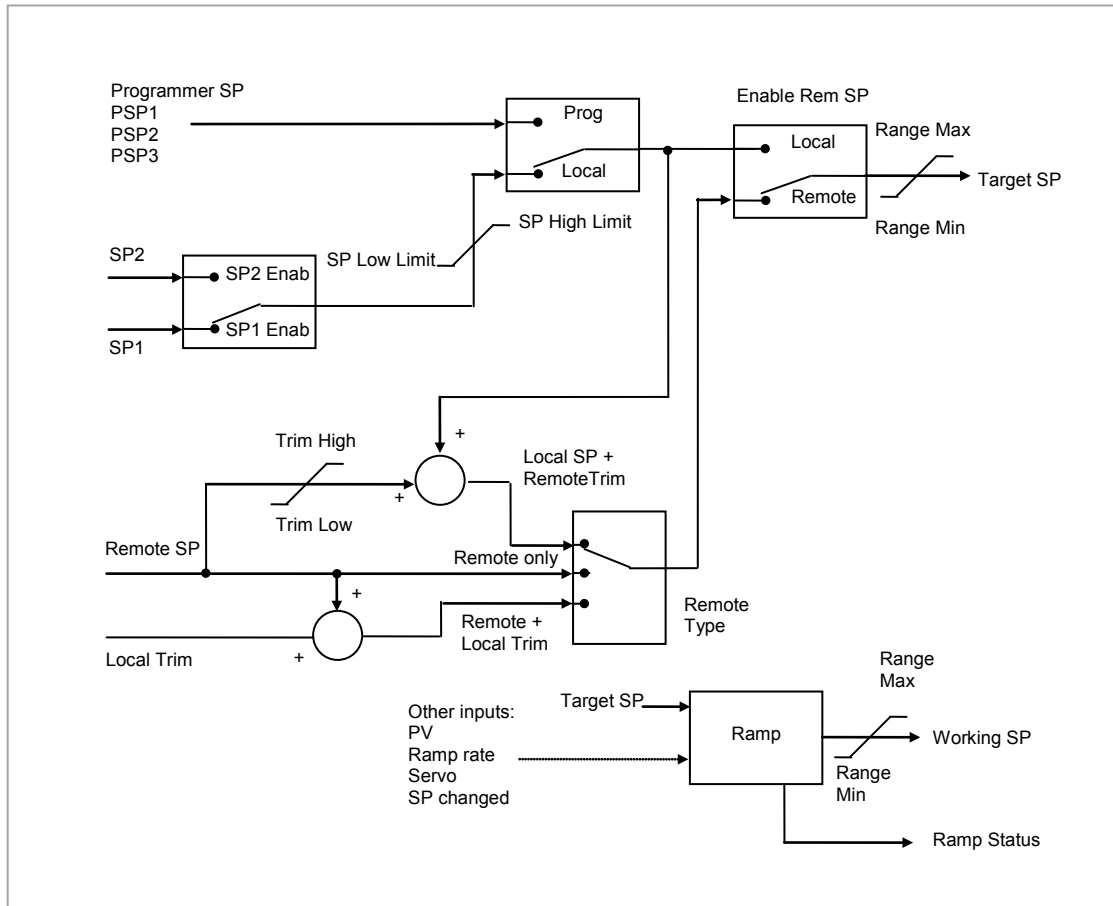

Figure 21-12: Setpoint Function Block

### 21.7.1 Loop Parameters - Setpoint

A summary of the parameters used to configure the setpoints are listed in the following table:-

List Header – Lp1 or Lp2		Sub-header: SP			
Name ⌚ to select	Parameter Description	Value Press ▼ or ▲ to change values		Default	Access Level
Range Hi	The Range limits provide a set of absolute maximums and minimums for setpoints within the control loop. Any derived setpoints are ultimately clipped to be within the Range limits. If the Proportional Band is configured as % of Span, the span is derived from the Range limits.	-99999 to 99999			Conf
Range Lo					Conf
SP Select	Select local or alternate setpoint	SP1 SP2	Setpoint 1 Setpoint 2	SP1	L3
SP1	Primary setpoint for the controller	Between SP high and SP low limits			L3
SP2	Setpoint 2 is the secondary setpoint of the controller. It is often used as a standby setpoint.				L3
SP HighLim	Maximum limit allowed for the local setpoints	Between Range Hi and SP LowLim		Range Hi	L3
SP LowLim	Minimum limit allowed for the local setpoints	Between SP HiLim and Range Lo		Range Lo	L3
Alt SP En	To enable the alternative setpoint to be used. This may be wired to a source such as the programmer Run input. <a href="#">See note 1</a>	No Yes	Alternative setpoint disabled Alternative setpoint enabled		L3
Alt SP	This may be wired to an alternative source such as the programmer or remote setpoint <a href="#">See note 1</a>				L3
Rate	Limits the maximum rate at which the working setpoint can change. The rate limit may be used to protect the load from thermal shock which may be caused by large step changes in setpoint.	Off or 0.1 to 9999.9 engineering units per minute		Off	L3
RateDone	Flag which indicates when the setpoint is changing or completed	No Yes	Setpoint changing Complete		R/O
SPRate Disable	Setpoint rate disable. Does not appear if 'Rate' = 'Off'	No Yes	Enabled Disabled	Off	L3
ServoToPV	Servo to PV Enable When Rate is set to any value other than Off and Servo to PV is enabled, changing the active SP will cause the working SP to servo to the current PV before ramping to the new target SP.	No Yes	Disabled Enabled	No	Conf R/O in L3
SP Trim	Trim is an offset added to the setpoint. The trim may be either positive or negative, the range of the trim may be restricted by the trim limits Setpoint trims may be used in a retransmission system. A master zone may retransmit the setpoint to the other zones, a local trim may be applied to each zone to produce a profile along the length of the machine	Between SP Trim Hi and SP Trim Lo			L3
SP Trim Hi	Setpoint trim high limit				L3
SP Trim Lo	Setpoint trim low limit				L3
Man Track	Manual track enable. To allow the Local SP to follow the value of the current PV when the controller is in Manual mode. See also section 21.7.5	Off On	Manual tracking disabled Manual tracking enabled	Off	L3 R/O

List Header – Lp1 or Lp2		Sub-header: SP			
Name ⌚ to select	Parameter Description	Value Press ⏴ or ⏵ to change values		Default	Access Level
SP Track	Setpoint track enable. To allow the Local SP to follow the value of the Remote SP. See also section 21.7.4	Off On	Setpoint tracking disabled Setpoint tracking enabled	Off	Conf
Track PV	The programmer tracks the PV when it is servoing or tracking. See also section 21.7.5				L3 R/O
Track SP	Manual Tracking Value. The SP to track for manual tracking. See also section 21.7.4.				L3 R/O
SPIntBal	SP Integral Balance This is also known as debump in some instances. It forces the integral to be balanced upon changes in target setpoint	Off On		Off	L3 R/O Alterable in config



**Note 1:** Connections to the programmer are made automatically when the loop and programmer are enabled and there are no existing connections to these parameters.

### 21.7.2 Setpoint Limits

The setpoint generator provides limits for each of the setpoint sources as well as an overall set of limits for the loop. These are summarised in the diagram below.

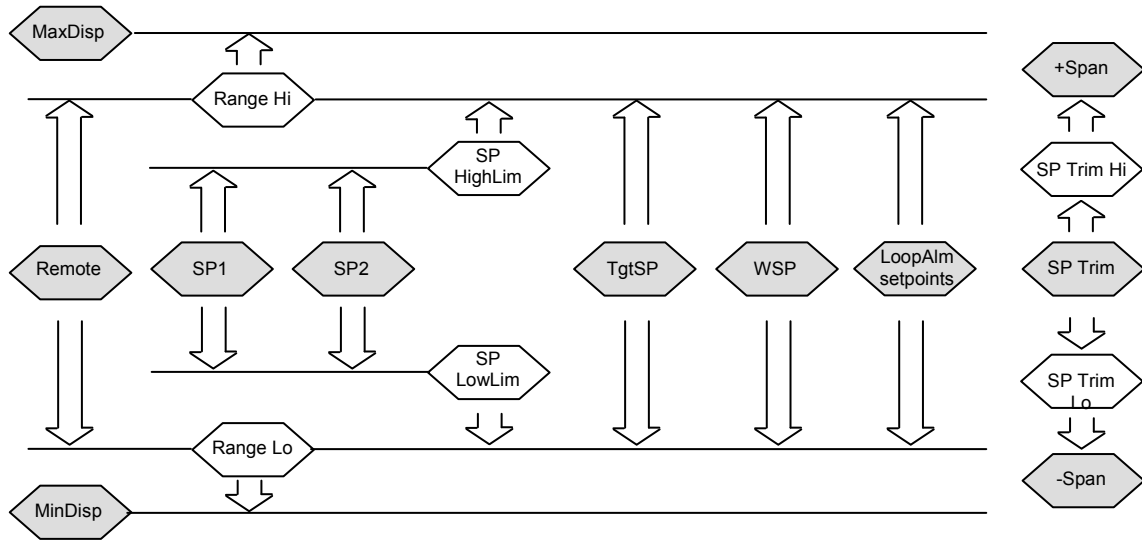

Figure 21-13: Setpoint Limits

- ☺ **'Range Hi'** and **'Range Lo'** provide the range information for the control loop. They are used in control calculations to generate proportional bands.  $\text{Span} = \text{Range Hi} - \text{Range Lo}$ .

### 21.7.3 Setpoint Rate Limit

Allows the rate of change of setpoint to be controlled. This prevents step changes in the setpoint. It is a simple symmetrical rate limiter and is applied to the working setpoint which includes setpoint trim. It is enabled by the **'Rate'** parameter. If this is set to Off then any change made to the setpoint will be effective immediately. If it is set to a value then any change in the setpoint will be effected at the value set in units per minute. Rate limit applies to SP1, SP2 and Remote SP.

When rate limit is active the **'RateDone'** flag will display **'No'**. When the setpoint has been reached this parameter will change to **'Yes'**. This flag will be cleared if the target setpoint subsequently changes.

When **'Rate'** is set to a value (other than Off) an additional parameter **'SPRate Disable'** is displayed which allows the setpoint rate limit to be turned off and on without the need to adjust the **'Rate'** parameter between Off and a value.

If the PV is in sensor break, the rate limit is suspended and the working setpoint takes the value of 0. On sensor break being released the working setpoint goes from 0 to the selected setpoint value at the rate limit.

### 21.7.4 Setpoint Tracking

The setpoint used by the controller may be derived from a number of sources. For example:-

1. Local setpoints SP1 and SP2. These may be selected through the front panel using the parameter 'SP Select', through digital communications or by configuring a digital input which selects either SP1 or SP2. This might be used, for example, to switch between normal running conditions and standby conditions. If Rate Limit is switched off the new setpoint value is adopted immediately when the switch is changed.
2. A programmer generating a setpoint which varies over time, see Chapter 22. When the programmer is running the 'TrackSP' and 'TrackPV' parameters update continuously so that the programmer can perform its own servo (see also section 22.10). This is sometimes referred to as '**Program Tracking**'.
3. From a Remote analogue source. The source could be an external analogue input into an analogue input module wired to the 'Alt SP' parameter or a User Value wired to the 'Alt SP' parameter. The remote setpoint is used when the parameter 'Alt SP En' is set to 'Yes'.

**Setpoint tracking** (sometimes referred to as **Remote Tracking**) ensures that the Local setpoint adopts the Remote setpoint value when switching from Local to Remote to maintain bumpless transfer from Remote to Local. Bumpless transfer does not take place when changing from Local to Remote. Note that if Rate Limit is applied the setpoint will change at the rate set when changing from Local to Remote.

### 21.7.5 Manual Tracking

When the controller is operating in manual mode the currently selected SP (SP1 or SP2) tracks the PV. When the controller resumes automatic control there will be no step change in the resolved SP. Manual tracking does not apply to the remote setpoint or programmer setpoint.

## 21.8 Output Function Block

The output function block performs the loop output control algorithms. It selects the correct output sources to be used, determines whether to heat or cool and then applies limits. Power feed forward and non-linear cooling are also applied.

It is this block that manages the output in exception conditions such as start up and sensor break. .

The outputs, 'Ch1 Output' and 'Ch2 Output', are normally connected to an output module where they are converted into an analogue or time proportioned signal for electrical heating, cooling or valve movement.

### 21.8.1 Loop Parameters - Output

A summary of the parameters used to configure output are listed in the following table:-

List Header – Lp1 or Lp2		Sub-header: OP		
Name Ⓞ to select	Parameter Description	Value Press ▼ or ▲ to change values	Default	Access Level
Output Hi	Maximum output power delivered by channels 1 and 2. By reducing the high power limit, it is possible to reduce the rate of change of the process, however, care should be taken as reducing the power limit will reduce the controllers ability to react to disturbance.	Between Output Lo and 100.0%	100.0	L3
Output Lo	Minimum (or maximum negative) output power delivered by channels 1 and 2	Between Output Hi and -100.0%	0.0 or -100.0	L3
Ch1 Output	Channel 1 (Heat) output. The Ch1 output is the positive power values (0 to Output Hi) used by the heat output. Typically this is wired to the control output (time proportioning or DC output).	Between Output Hi and Output Lo		L3 R/O
Ch2 Output	The Ch2 output is negative portion of the control output (0 – Output Lo) for heat/cool applications. It is inverted to be a positive number so that it can be wired into one of the outputs (time proportioning or DC outputs).	Between Output Hi and Output Lo		L3 R/O
Ch2 DeadB	Ch1/Ch2 Deadband is a gap in percent between output 1 going off and output 2 coming on and vice versa. For on/off control this is taken as a percentage of the hysteresis.	Off to 100.0%	Off	L3
The following four parameters only appear if Ch1/2 are configured for valve position control (Ch1/2 Control = VPU/VPB in Lp Setup page)				
Ch1 TravelT	Valve travel time for the channel 1 valve to travel from 0% (closed) to 100% (open). In a Valve positioner application, Channel one is connected to both a Raise and a Lower output. In a Heat/Cool application Channel 1 is the heat valve.	0.0 to 1000.0 seconds		L3
Ch2 TravelT	Travel time for Channel 2 valve to travel from 0% (closed) to 100% (open). In a Heat/Cool application, Channel 2 is the cool valve.	0.0 to 1000.0 seconds		L3

List Header – Lp1 or Lp2		Sub-header: OP			
Name ⌚ to select	Parameter Description	Value Press ⏴ or ⏵ to change values		Default	Access Level
Nudge Raise	Causes the valve to move by one minimum on time towards the CH1 open position See also section 21.8.9				L3
Nudge Lower	Causes the valve to move by one minimum on time towards the CH1 close position See also section 21.8.9				
The following six pot feedback parameters appear if Ch1/2 are configured for VPB – valve position bounded mode					
PotCal	Starts the potentiometer calibration by selecting which potentiometer to calibrate. e.g. if a valve is used to control the cooling of a process, then the ch2 potentiometer must be calibrated. Note: Potentiometer input modules must be fitted and wired directly to the loops Ch1 or Ch2 pot position parameters. See section 10.3.9 and 8.2.4. for details on pot calibration	Off CH1 CH2	Pot cal disabled Calibrate channel 1 Calibrate channel 2		Conf
Ch1 Pot Pos	The position of the channel 1 actuator as measured by a pot position feedback. This is used by the bounded VP control algorithm as the PV of the positional loop. Note: 'PotCal' can be used to automatically calibrate the potentiometer feedback.				L3
Ch1 Pot Brk	Indicates the Channel 1 pot is broken. This parameter requires that the pot position is wired from an input channel. This value is taken from the wire.	Off On		Off	L3
Ch2 Pot Pos	The position of the channel 2 actuator as measured by a pot position feedback. This is used by the bounded VP control algorithm as the PV of the positional loop				L3
Ch2 Pot Brk	Indicates the Channel 2 pot is broken. This value is taken from the wire and is provided by the pot input module.	Off On		Off	L3
PotBrk Mode	Defines the action which takes place if the feedback potentiometer becomes open circuit. An alarm message is given whenever the fault occurs.	Raise Lower Rest Model	The valve is opened The valve is closed The valve remains in its current position The controller tracks the actual position of the valve and sets up a model of the system so that it continues to control when the potentiometer becomes faulty		L3
Rate	Limits the rate at which the output from the PID can change. Output rate limit is useful in preventing rapid changes in output from damaging the process or the heater elements. See also section 21.8.3.	Off to 9999.9 percent per minute		Off	L3
Ch1 OnOff Hyst	Channel hysteresis - only shown when the channel is configured as OnOff.	0.0 to 200.0		10.0	L3
Ch2 OnOff Hyst	See also section 21.8.10.	0.0 to 200.0		10.0	L3
Sbrk Mode	To set the action which takes place in the event of a sensor break.	SbrkOP	The output will be the value configured by 'Sbrk OP' (the next parameter)..	SbrkOP	L3

List Header – Lp1 or Lp2		Sub-header: OP			
Name Ⓞ to select	Parameter Description	Value Press ▼ or ▲ to change values		Default	Access Level
	See also section 21.8.4.	Hold	Freeze the current output level at the point when sensor break occurs		
Sbrk OP	Sets the level which the output power goes to in the event of a sensor break, and 'SbrkMode' is set to 'SbrkOP'. See also section 21.8.4.	Clipped between 'Output Hi' and 'Output Lo'			L3
Safe OP	Sets the output level to be adopted when the loop is inhibited.	Clipped between 'Output Hi' and 'Output Lo'			L3
Man Mode	Selects the mode of manual operation.	Track	In auto the manual output tracks the control output such that a change to manual mode will not result in a bump in the output.		L3
		Step	On transition to manual the output becomes the ForcedOP.		
		LastMOP	On transition to manual the output will be the manual op value as last set by the operator.		
ManOP	The output when the loop is in manual. Note: In manual mode the controller will still limit the maximum power to the power limits, however, it could be dangerous if the instrument is left unattended at a high power setting. It is important that the over range alarms are configured to protect your process. <i>We recommend that all processes are fitted with an independent over range "policeman"</i>	Between Output Hi and Output Lo			R/O in L3
ForcedOP	Forced manual output value. When 'Man Mode' = 'Step' the manual output does not track and on transition to manual the target output will step from its current value to the 'ForcedOP' value.	-100.0 to 100.0		0.0	L3
Manual Startup	Manual start up mode.	Off	Controller will power up in automatic or manual mode as set when it was powered down.	Off	Conf R/O in L3
		On	Controller will always power up in manual mode		
Pff En	Power feedforward enable. This adjusts the output signal to compensate for changes in voltage to the controller supply. See also section 21.8.6	No	Disabled		
		Yes	Enabled		
Pwr In	Measured power input				R/O in L3
Cool Type	Selects the type of cooling channel characterisation to be used. Can be configured as water, oil or fan cooling. See also section 21.8.7.	Linear Oil Water Fan	These are set to match the type of cooling medium applicable to the process		Conf R/O in L3
FF Type	Feedforward type The following four parameters appear if FF Type ≠ None See also section 21.8.8.	None	No signal fed forward	None	Conf
		Remote	A remote signal fed forward		
		SP	Setpoint fed forward		
		PV	PV fed forward		
FF Gain See also section 21.8.8.	Defines the gain of the feedforward value, the feed forward value is multiplied by the gain				Conf



List Header – Lp1 or Lp2		Sub-header: OP			
Name ⌚ to select	Parameter Description	Value Press ▼ or ▲ to change values		Default	Access Level
FF Offset	Defines the offset of the feedforward value this is added to the scaled feedforward. See also section 21.8.8.				L3
FF Trim Lim	Feedforward trim limits the effect of the PID output. Defines symmetrical limits around the PID output, such that this value is applied to the feedforward signal as a trim. See also section 21.8.8.				L3
FF OP	The calculated Feedforward Value. See also section 21.8.8.				R/O in L3
Track OP	Output track. This is the value for the loop output to track when OP Track is Enabled. Output Track forces the control output to a defined value. The PID is kept in AUTO and tracks the output. The track value is wireable or user settable. This mode is similar to the loop entering manual.	-100 to 100%			L3
Track En	When enabled, the output of the loop will follow the track output value. The loop will bumplessly return to control when tracking is turned off.	Off On	Disabled Enabled		L3
RemOPL	Remote output low limit. Can be used to limit the output of the loop from a remote source or calculation. This must always be within the main limits.	-100.0 to 100.0			L3
RemOPH	Remote output high limit	-100.0 to 100.0			L3

### 21.8.2 Output Limits

The diagram shows where output limits are applied.

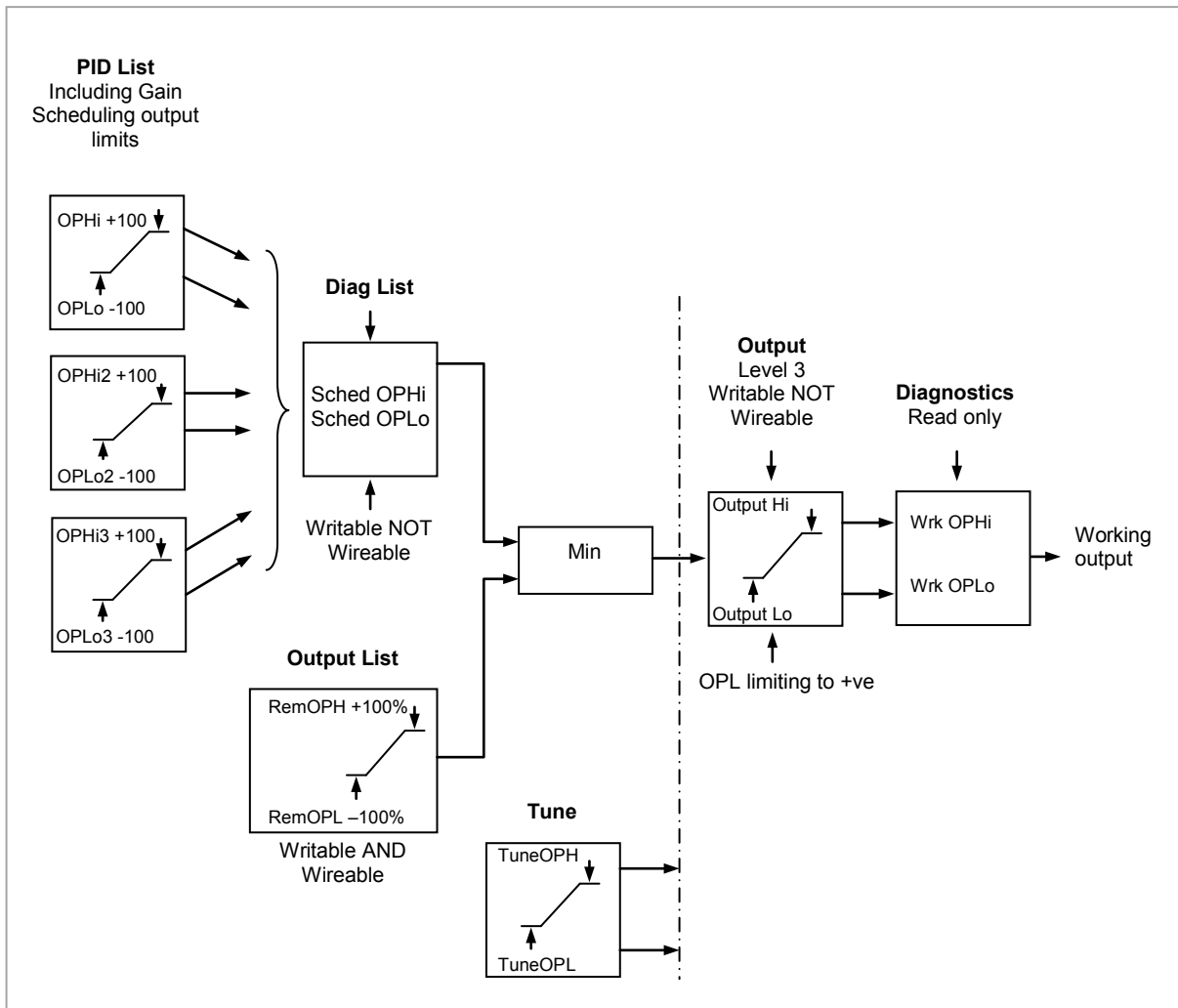

Figure 21-14: Output Limits

- Individual output limits may be set in the PID list for each set of PID parameters when gain scheduling is used.
- The parameters 'Sched OPHi' and 'Sched OPHLo', found in the Diagnostics List, may be set to values which override the gain scheduling output values.
- A limit may also be applied from an external source. These are 'RemOPH' and 'RemOPLo' (Remote output high and low) found in the Output List. These parameters are wireable. For example they may be wired to an analogue input module so that a limit may applied through some external strategy. If these parameters are not wired  $\pm 100\%$  limit is applied every time the instrument is powered up.
- The tightest set (between Remote and PID) is connected to the output where an overall limit is applied using parameters 'Output Hi' and 'Output Lo' settable in Level 3.
- 'Wrk OPHi' and 'Wrk OPHLo' found in the Diagnostics list are read only parameters showing the overall working output limits.

The tune limits are a separate part of the algorithm and are applied to the output during the tuning process. The overall limits 'Output Hi' and 'Output Lo' always have priority.

### 21.8.3 Output Rate Limit

The output rate limiter is a simple rate of change limiter which will prevent the control algorithm demanding step changes in output power. It may be set in percent per minute.

The rate limit is performed by determining the direction in which the output is changing, and then incrementing or decrementing the Working Output ('Work OP' in the Main list) until 'Work OP' = the required output (Target OP).

The amount by which to increment or decrement will be calculated based on the sampling rate of the algorithm (i.e. 110ms) and the rate limit that has been set. If the change in output is less than the rate limit increment the change will take effect immediately.

The rate limit direction and increment will be calculated on every execution of the rate limit. Therefore, if the rate limit is changed during execution, the new rate of change will take immediate effect. If the output is changed whilst rate limiting is taking place, the new value will take immediate effect on the direction of the rate limit and in determining whether the rate limit has completed.

The rate limiter is self-correcting such that if the increment is small and is lost in the floating point resolution, the increment will be accumulated until it takes effect.

The output rate limit will remain active even if the loop is in manual mode

### 21.8.4 Sensor Break Mode

Sensor break is detected by the measurement system and a flag is passed to the control block which indicates sensor failure. On the loop being informed that a sensor break has occurred it may be configured using '**Sbrk Mode**' to respond in one of two ways. The output may go to a pre-set level or remain at its current value.

The pre-set value is defined by the parameter '**SbrkOP**'. If rate limit is not configured the output will step to this value otherwise it will ramp to this value at the rate limit.

If configured as '**Hold**' the output of the loop will stay at its last good value. If Output Rate Limit (Rate) has been configured a small step may be seen as the working output will limit to the 2 second old value.

On exit from sensor break the transfer is bumpless – the power output will ramp from its pre-set value to the control value.

### 21.8.5 Forced Output

This feature enables the user to specify what the output of the loop should do when moving from automatic control to manual control. The default is that the output power will be maintained and is then editable by the user. If forced manual is enabled, two modes of operation can be configured. The forced manual step setting means the user can set a manual output power value and on transition to manual the output will be forced to that value. If '**TrackEn**' is enabled the output steps to the forced manual output and then subsequent edits to the output power are tracked back into the manual output value.

The parameters associated with this feature are '**ForcedOP**' and '**Man Mode**' = '**Step**'.

### 21.8.6 Power Feed Forward

Power feedforward is used when driving a heating element. It monitors the line voltage and compensates for fluctuations before they affect the process temperature. The use of this will give better steady state performance when the line voltage is not stable.

It is mainly used for digital type outputs which drive contactors or solid state relays. Because it only has value in this type of application it can be switched off using the parameter '**Pff En**'. It should also be disabled for any non-electric heating process. It is generally not necessary when analogue thyristor control is used since compensation for power changes is included in the thyristor driver.

Consider a process running at 25% power, with zero error and then the line voltage falls by 20%. The heater power would drop by 36% because of the square law dependence of power on voltage. A drop in temperature would result. After a time, the thermocouple and controller would sense this fall and increase the ON-TIME of the contactor just enough to bring the temperature back to set point. Meanwhile the process would be running a bit cooler than optimum which may cause some imperfection in the product.

With power feedforward enabled the line voltage is monitored continuously and ON-TIME increased or decreased to compensate immediately. In this way the process need never suffer a temperature disturbance caused by a line voltage change.

'Power Feedforward' should not be confused with 'Feedforward' which is described in section 21.8.8.

### 21.8.7 Cooling Algorithm

The method of cooling may vary from application to application and is selected using the parameter '**Cool Type**'.

For example, an extruder barrel may be cooled by forced air (from a fan), or by circulating water or oil around a jacket. The cooling effect will be different depending on the method. The cooling algorithm may be set to linear where the controller output changes linearly with the PID demand signal, or it may be set to water, oil or fan where the output changes non-linearly against the PID demand. The algorithm provides optimum performance for these methods of cooling.

#### 21.8.7.1 Oil Cooling

Being non-evaporative, oil cooling is pulsed in a linear manner. It is deep and direct and will not need such a high cool gain as fan cooling.

#### 21.8.7.2 Water cooling

A complication with water-cooling comes if the zone is running well above 100°C.

Usually the first few pulses of water will flash off into steam giving a greatly increased cooling capacity due to the latent heat of evaporation.

When the zone settles down, less or even no evaporation is a possibility and the cooling is less severe.

To handle evaporative cooling choose the water cool mode from the controller parameter list.

This technique delivers much shortened pulses of water for the first few percent of the cooling range, when the water is likely to be flashing off into steam. This compensates for the transition out of the initial strong evaporative cooling.

#### 21.8.7.3 Fan Cooling

This is much gentler than water cooling and not so immediate or decisive because of the long heat transfer path through the finned aluminium cooler and barrel.

With fan cooling, a cool gain setting of 3 upwards would be typical and delivery of pulses to the blower would be linear, i.e. the on time would increase proportionally with percentage cool demand determined by the controller.

**21.8.8 Feedforward**

Feedforward is a value, which is scaled and added to the PID output, before any limiting. It can be used for the implementation of cascade loops or constant head control. Feedforward is implemented such that the PID output is limited to trim limits and acts as a trim on a FF value. The FF value is derived either from the PV or setpoint by scaling the PV or SP by the 'FF Gain' and 'FF Offset'. Alternatively, a remote value may be used for the FF value, this is not subject to any scaling. The resultant FF value is added to the limited PID OP and becomes the PID output as far as the output algorithm is concerned. The feedback value then generated must then have the FF contribution removed before being used again by the PID algorithm. The diagram below shows how feedforward is implemented

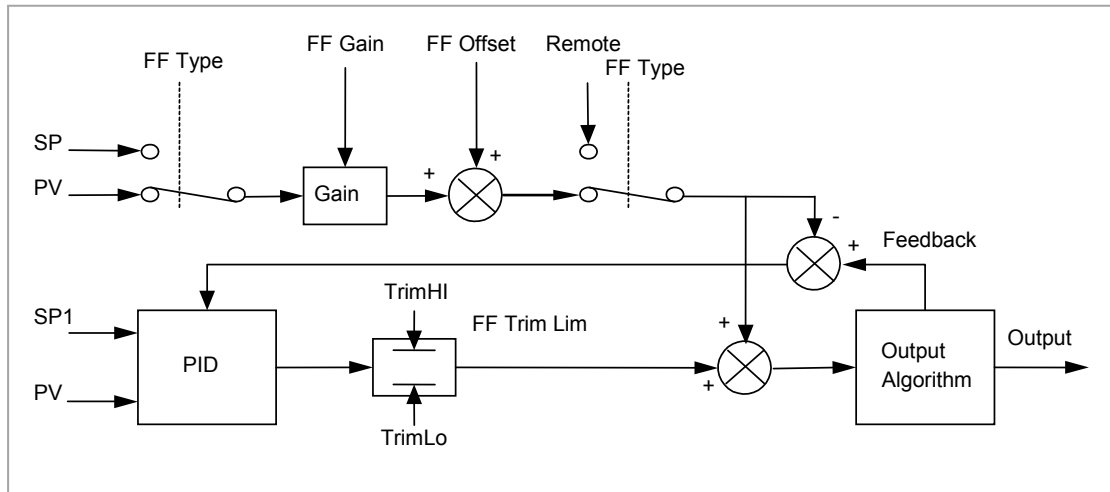

**Figure 21-15: Implementation of Feedforward**

**21.8.9 Nudge Raise/Lower**

These parameters may be wired to digital inputs (for example a pushbutton) to allow the valve to be manually nudged open or closed. The duration of the nudge is determined by the value of the parameter 'Min OnTime' which will be found in the fixed relay output list AA section 9.2 but more appropriately for valve position outputs in the Dual Relay or Triac output modules section 10.3.1.

The minimum on/off time should be set large enough to overcome the inertia of the valve or the slack in the linkage but not so slow that the valve opens and closes too widely which may cause oscillation of the output and consequent changes in the temperature. If a relay is used to drive the valve the 'Min OnTime' should be set in the order of seconds so that the relay does not switch too rapidly which may cause premature wear. For this reason it is often preferable to switch valve motors using triacs.

To nudge the valve press the pushbutton momentarily. The shortest time that the valve can open or close is 110ms. If the pushbutton is depressed for longer than 110ms the valve will open or close for as long as the pushbutton is depressed, until it is fully open/closed, as shown in the diagram below:

**'Min OnTime' = Auto**

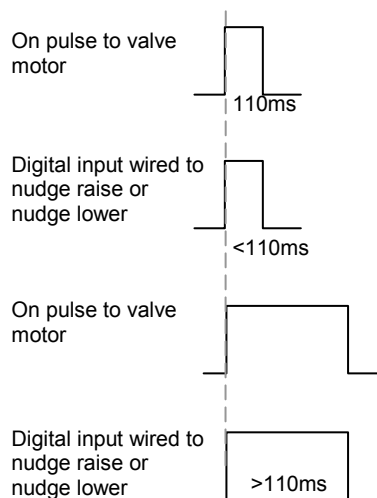

**'Min OnTime' = 10 seconds (for example)**

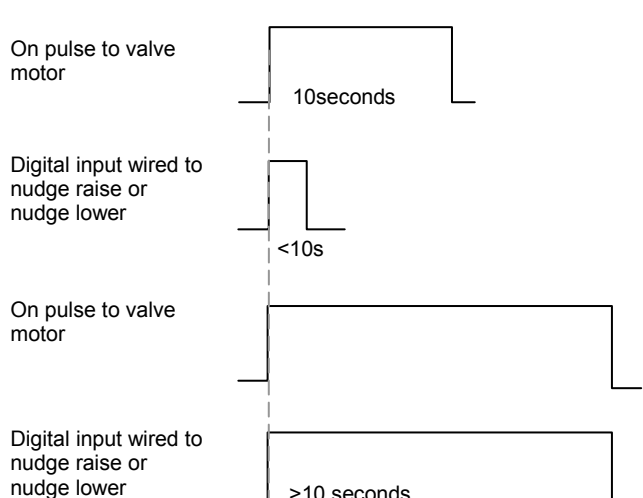

**Note:** If the digital input signal is held on will drive fully open or closed.

**21.8.10 Effect of Control Action, Hysteresis and Deadband**

For temperature control 'Control Act' will be set to 'Rev'. For a PID controller this means that the heater power decreases as the PV increases. For an on/off controller, output 1 (usually heat) will be on (100%) when PV is below the setpoint and output 2 (usually cool) will be on when PV is above the setpoint

**Hysteresis** applies to on/off control only and is set in the units of the PV. In heating applications the output will turn off when the PV is at setpoint. It will turn on again when the PV falls below SP by the hysteresis value. This shown in Figures 21-16 and 21-17 below for a heat and cool controller.

The hysteresis is used to prevent the output from chattering at the control setpoint. If the hysteresis is set to 0 then even the smallest change in the PV when at setpoint will cause the output to switch. The hysteresis should be set to a value which provides an acceptable life for the output contacts, but which does not cause unacceptable oscillations in the PV.

If this performance is unacceptable, it is recommended that you try PID control.

**Deadband 'Ch2 DeadB'** can operate on both on/off control or PID control where it has the effect of widening the period when no heating or cooling is applied. However, in PID control its effect is modified by both the integral and derivative terms. Deadband might be used in PID control, for example, where actuators take time to complete their cycle thus ensuring that heating and cooling are not being applied at the same time. Deadband is likely to be used, therefore, in on/off control only. The second example below adds a deadband of 20 to the first example.

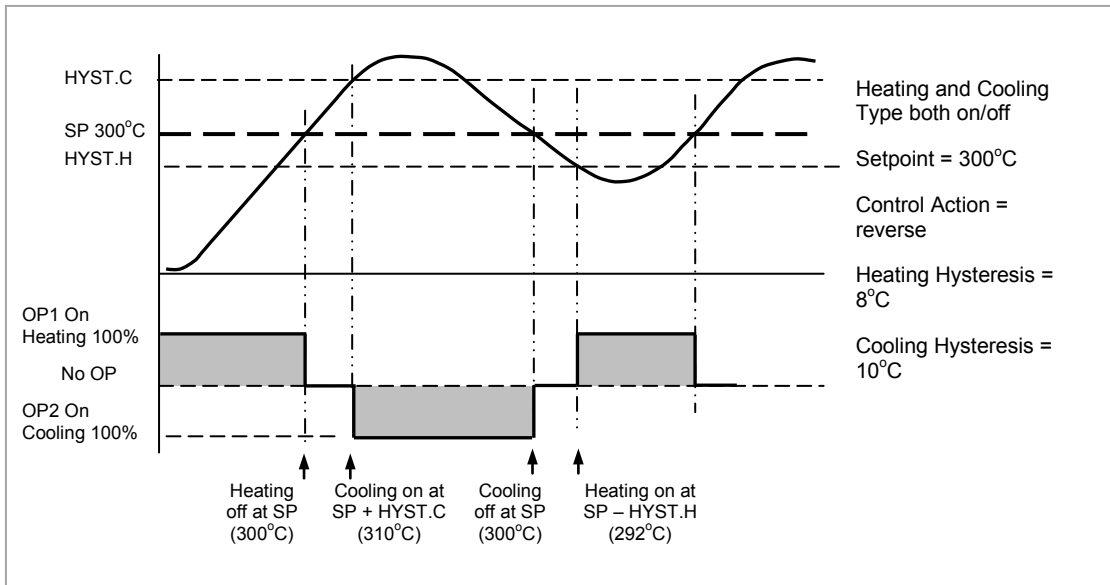

**Figure 21-16: Deadband OFF**

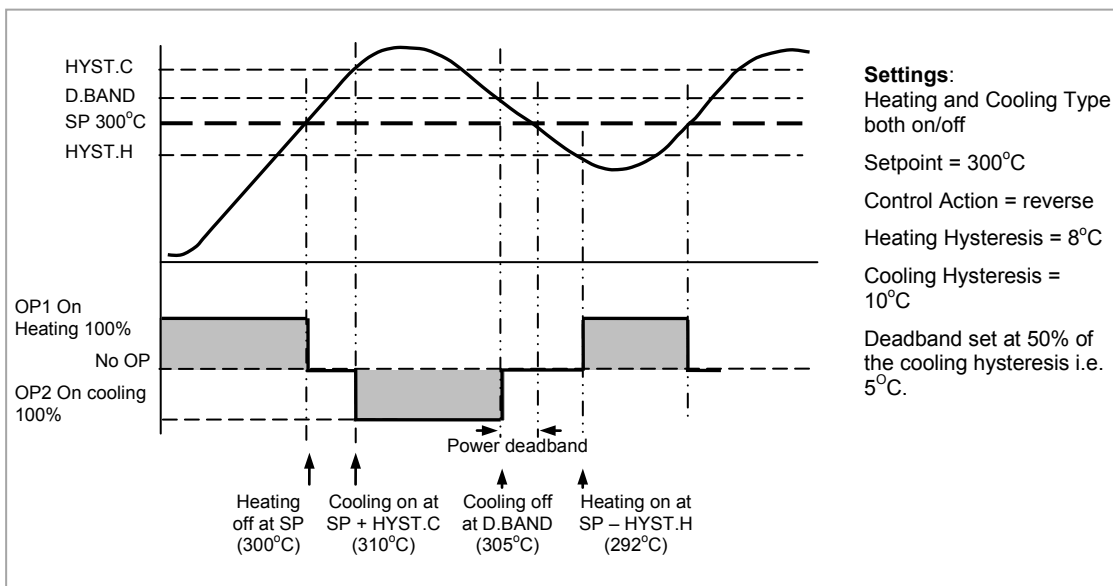

**Figure 21-17: Deadband ON (set at 50% of Cooling).**

## 21.9 Diagnostics Function Block

These are generally read only parameters which may be used for diagnostic purposes.

They may be wired to produce an application specific strategy. For example, the loop break alarm may be wired to the PV of the AA Relay or other output module to produce a physical output if the loop break time is exceeded.

List Header – Lp1 or Lp2		Sub-header: Diag			
Name Ⓢ to select	Parameter Description	Value Press ▼ or ▲ to change values		Default	Access Level
Error	The difference between the setpoint and the PV.	Range limits			L3 R/O
Loop Mode	Reads the mode of the loop i.e. it is Auto, Manual or Off mode. See sections 2.4 and 2.6.	Auto	Automatic		In iTools only
		Man	Manual		
		Off	Loop off		
Target OP	The requested control output, this could be the target of the active output if an output rate limit is configured.				L3 R/O
Wrk OPHi	Working output high limit. This is the value used to limit the output power of the loop and is derived from the gain scheduled limit, the remote limit and the safety limit.	Wrk OPLo to 100%			L3 R/O
Wrk OPLo	Working output low limit. This is the value used to limit the output power of the loop and is derived from the gain scheduled limit, the remote limit and the safety limit.	-100% to Wkg OPHi			L3 R/O
Lp Break	Loop break alarm. This is active when the loop break time LBT, set in the PID list (section 21.5.10) is exceeded	No	Loop break not in alarm		L3 R/O
		Yes	Active		
Prop OP	Shows the contribution of the Proportional term to the control output.				L3 R/O
InOP	Shows the contribution of the Integrator to the control output.				L3 R/O
Deriv OP	Shows the contribution of the Derivative to the control output.				L3 R/O
SensorB	Indicates the status of the sensor break	Off	No sensor break alarm		L3 R/O
		On	Sensor break		
Sched PB	The scheduled proportional band	These are the current values of the control time constants as set in the PID list and determined by Gain Scheduling			L3
Sched Ti	The scheduled integral time				
Sched Td	The scheduled Derivative time				
Sched R2G	The scheduled relative cool gain				
Sched CBH	The scheduled cutback high				
Sched CBL	The scheduled cutback low				
Sched MR	The scheduled manual reset				
Sched LpBrk	The scheduled loop break time				
Sched OPHi	The scheduled output high limit				
Sched OPLo	The scheduled output low limit				

## 22. Chapter 22 Setpoint Programmer

The purpose of a setpoint programmer is to vary the setpoint in a controlled manner over a set period of time.

The resulting **Program** is divided into a flexible number of **Segments** - each being a unit of time. The total number of segments available in 3500 controller is **500** (or a maximum of **50 per program**) and it is possible to store up to **50 separate programs**.

It is often necessary to switch external devices at particular times during the program. Up to eight digital 'event' outputs can be programmed to operate during those segments.

In controllers fitted with software versions 1.XX a **single programmer block** is provided. This is suitable for applications such as heat treatment or firing of ceramics materials where a single variable (temperature) is controlled. Parameters specific to this earlier version are listed in the Appendix at the end of this chapter.

In controllers fitted with software versions 2 onwards **two single programmer blocks** are included. The dual controller allows two process variables to be controlled and is suitable for applications such as environmental chambers controlling, for example, temperature and humidity.

An example of a dual program and two event outputs is shown below.

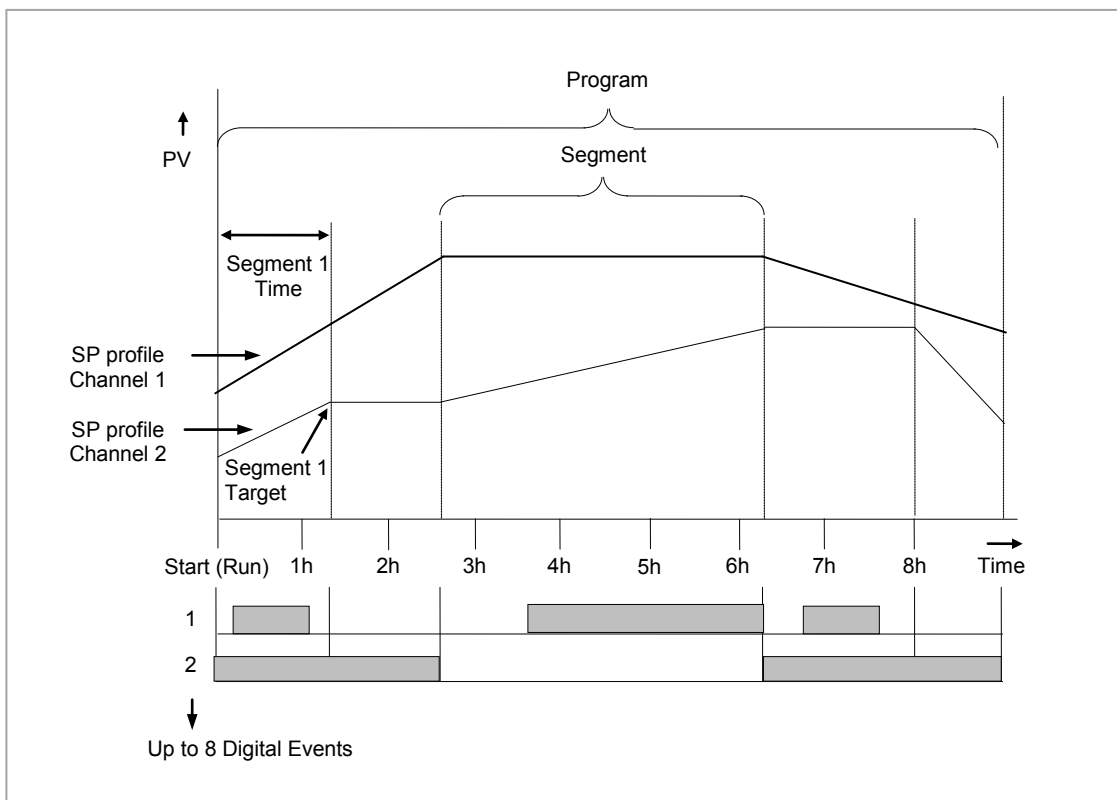

**Note:** Event 1 may be a 'Timed Event', as shown above, whereby an on and off time can be set in each segment. See section 22.4.2.

Figure 22-1: Simple Two Profile Setpoint Program



## 22.1 Dual Programmer Modes

There are three modes in which the dual programmer can be configured. These are:-

### 22.1.1 SyncStart Programmer

In a SyncStart programmer the two profiles will start running together when 'RUN' is initiated. It is possible to configure a SyncStart programmer for Ch1 to 'wait' for a segment in Ch2 to catch up and vice versa. Wait is described in section 22.3.6. A SyncStart programmer can operate as a Ramp Rate programmer or Time to Target programmer (see next section) in each segment in the same way as the previous single program version.

### 22.1.2 SyncAll Programmer

In a SyncAll programmer the two profiles automatically synchronize at the end of every segment. However, in order to simplify its operation, this programmer is only available as a Time to Target programmer (see next section).

### 22.1.3 Single Channel Programmer

By default Channel 1 is run and is intended to be used with a single process variable.

☺ **The modes are configured in the Instrument Display Configuration Page – 'Inst Opt' described in section 6.4.**

## 22.2 Programmer Types

### 22.2.1 Time to Target Programmer

Each segment consists of a **single duration parameter** and a set of **target values** for the profiled variables.

1. The **duration** specifies the time that the segment takes to change the profiled variables from their current values to the new targets.
2. A **dwell** type segment is set up by leaving the target setpoint at the previous value.
3. A **Step** type segment is set up by setting the segment time to zero.

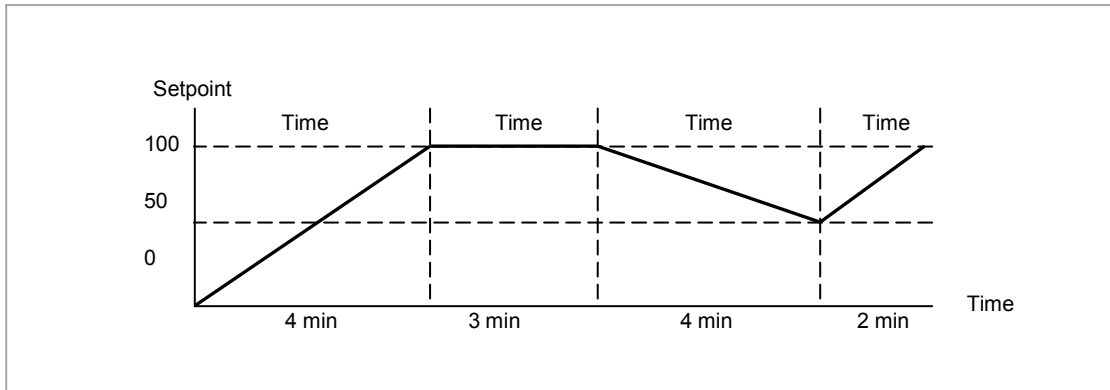

Figure 22-2: All Segments Configured as Time-to-Target

A SyncAll programmer can only be set as a Time to Target programmer

### 22.2.2 Ramp Rate Programmer

A ramp rate programmer specifies its ramp segments as maximum setpoint changes per time unit.

Each segment can be specified by the operator as **Ramp Rate, Dwell or Step** – see section 22.3 for a full listing of segment types.

1. Ramp Rate – the setpoint changes at a rate in units/time
2. Dwell – the time period is set – there is no need to set the target value as this is inherited from the previous segment
3. Step – specify target setpoint only – the controller will use that setpoint when the segment is reached

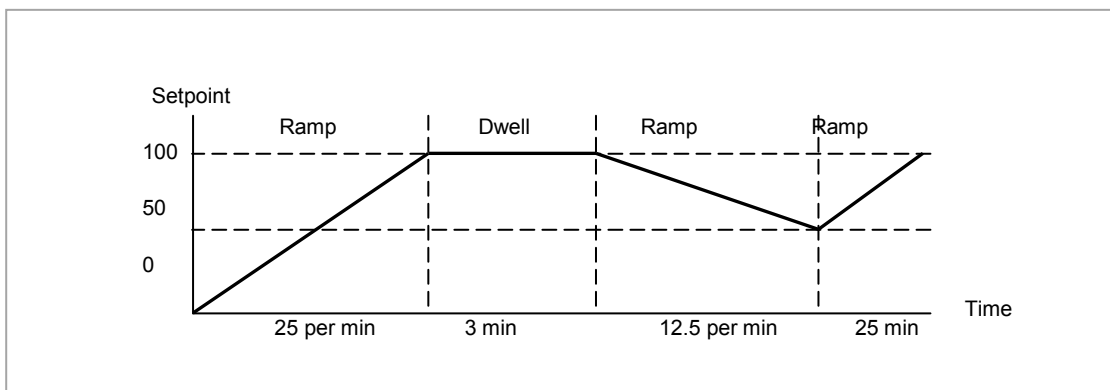

Figure 22-3: Ramp Rate Programmer

A SyncStart programmer can be set as a Ramp Rate or Time to Target programmer.

### 22.3 Segment Types

Depending on the type of program configured, a segment may be set as:-

#### 22.3.1 Rate

A Ramp segment provides a controlled change of setpoint from an original to a target setpoint. The duration of the ramp is determined by the rate of change specified. Two styles of ramp are possible in the range, Ramp-Rate or Time-To-Target.

The segment is specified by the target setpoint and the desired ramp rate. The ramp rate parameter is presented in engineering units ( $^{\circ}\text{C}$ ,  $^{\circ}\text{F}$ , Eng.) per real time units (Seconds, Minutes or Hours). If the units are changed, all ramp rates are re-calculated to the new units and clipped if necessary

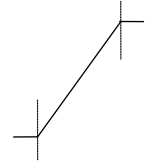

#### 22.3.2 Dwell

The setpoint remains constant for a specified period at the specified target. The operating setpoint of a dwell is inherited from the previous segment.

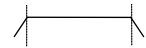

#### 22.3.3 Step

The setpoint changes instantaneously from its current value to a new value at the beginning of a segment. A Step segment has a minimum duration of 1 second.



#### 22.3.4 Time

A time segment defines the duration of the segment. In this case the target setpoint is defined and the time taken to reach this value. A dwell period is set by making the target setpoint the same value as the previous setpoint.

#### 22.3.5 GoBack

Go Back allows segments in a program to be repeated a set number of times. The diagram shows an example of a program which is required to repeat the same section a number of times and then continue the program.

When planning a program it is advisable to ensure that the end and start setpoints of the program are the same otherwise it will step to the different levels.

'Goback Seg' specifies the segment to go back to

'Goback Cycles' specifies the number of times the goback loop is executed

Overlapping Goback loops are disallowed

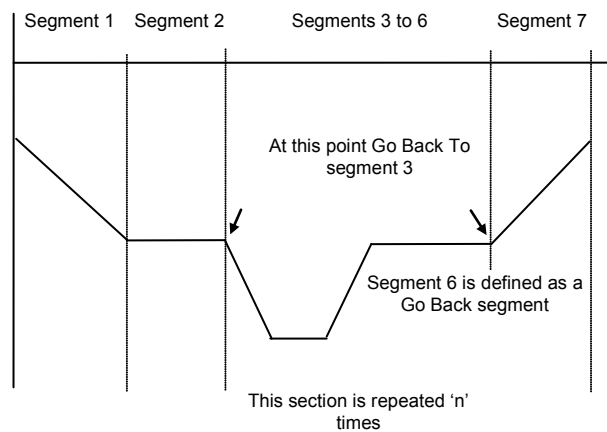

**Note:** If a second or more 'Go Back' segments are created, they cannot return to a segment before the previous 'Go Back' segment as shown.

In this diagram a Go Back segment can be created from 3 to 2 or 1. Go Back segments can also be created from 7 to 6 or 5 or 4 but not from 7 to 2 or 1

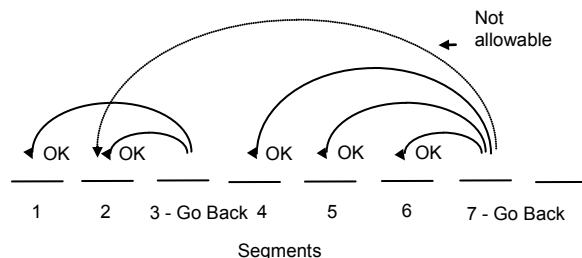

**22.3.6 Wait**

Wait specifies the criterion for which a segment cannot proceed to the next segment. Any segment can be defined as 'Wait' in the 'Program Edit' page. The next parameter is then '**Wait For**' and here you define the criterion.

'Wait For' criteria:-

None No action

PrgIn1 Wait until Input 1 is true

PrgIn2 Wait until Input 2 is true

PrgIn 1&2 Wait until Inputs 1 AND 2 are true

PrgIn 1or2 Wait until Inputs 1 OR 2 is true

PVWaitIP Wait until Wait criteria is true

Ch2Seg Wait if the specified segment in channel B has not reached its target

The above parameters may be wired to configure a Wait strategy. Examples of a simple strategy are, wait for a digital input or program event to become true or wait for a segment in program channel 1 to reach a defined PV before allowing Ch 2 to proceed to the next segment.

In a SyncStart programmer synchronization is achieved by selecting 'Wait For' = 'Ch2Sync' in the Program Edit menu.

Wait criteria for 'PVWaitIP' is that this parameter has reached a specified threshold. This is set by the parameter '**WaitVal**'. The following example shows various settings possible:-

'Wait For' set to 'PVWaitIP' PSP = 100 'WaitVal' = 5	
PVWait	Segment will wait until
Abs Hi	PVWaitIP >= 5
Dev Lo	PVWaitIP >= 95
Abs Lo	PVWaitIP <= 5
Dev Hi	PVWaitIP <= 105

**Constraints:-**

If Wait on Segment were offered on both channels without restrictions, it would be possible to set up a program such that both channels would have to wait for one another. An example is illustrated in the diagram below. Ch1 Seg 3 is set to wait for Ch2 Seg 1, followed by Ch2 Seg 3 set to wait for Ch1 Seg 2. It will not be possible to set conflicting situations in the controller since the following restrictions are imposed:-

The 'Ch2Seg' option is only offered in Channel 1

The 'Ch2Seg' must be ascending

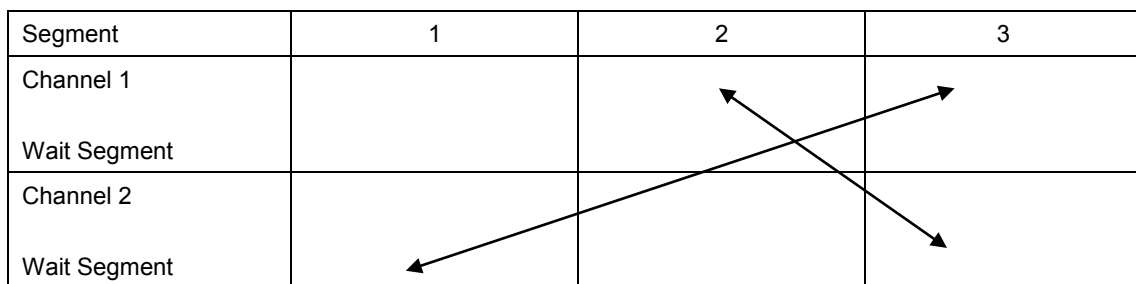

**22.3.7 Call**

A CALL segment is only available when single programmer mode is configured. Call segments may only be selected in instruments offering multiple program storage.

The Call segment allows programs to be nested within each other.

To prevent re-entrant programs from being specified, only higher number programs may be called from a lower program.

i.e. program 1 may call programs 2 through 50, but program 49 may only call program 50.

When a CALL segment is selected the operator may specify how many cycles the called program will execute. The number of cycles is specified in the calling program. If a called program has a number of cycles specified locally, they will be ignored.

A CALL segment will not have a duration, a CALL segment will immediately transfer execution to the called program and execute the first segment of that program.

Called programs do not require any modification, the calling program treats any END segments as return instructions.

The example shows Prog 50 (Ramp/Dwell/Ramp) inserted in place of segment 3/Program 1.

Prog 50 can be made to repeat using the 'Cycles' parameter

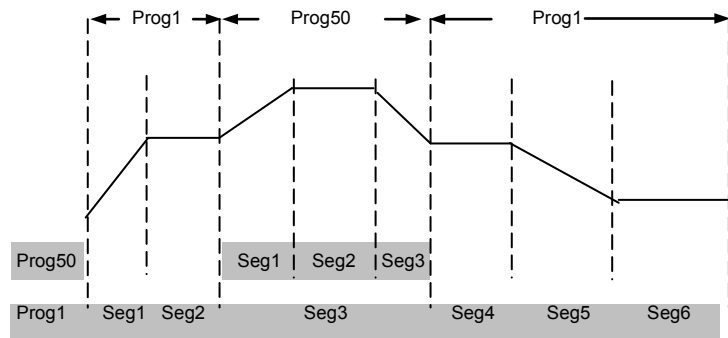

**22.3.8 End**

A program may contain one End segment. This allows the program to be truncated to the number of segments required.

The end segment can be configured to have an indefinite dwell at the last target setpoint or to reset to the start of the program or to go to a defined level of power output (SafeOP). This is selectable by the user.

If a number of program cycles are specified for the program, then the End segment is not executed until the last cycle has completed

## 22.4 Event Outputs

All segments, except GoBack, Wait and End Segments, have configurable events.  
Two types of events are provided namely, PV Events and Time Events.

### 22.4.1 PV Event

PV Events are essentially a simplified analogue alarm per segment based on the programmer PV input. The PV Event Output (PVEventOP) may be used to trigger the required response.

- Each Segment has one *PV Event Type (Off, Hi, Lo, Band\*)*
- Each Segment has one *PV Event Threshold/User value*
- Each channel has one *PV Event Input* (for the monitored variable)
- Each channel has one *PV Event OP (Off, On)*

**\* Band refers to deviation of the PV parameter from Programmer Setpoint (i.e. there is no reference input).**

If 'PV Event' is set to anything other than 'None' then the following parameter will be 'PV Threshold'. This sets the level at which the PV Event will be triggered.



**Note:** If PV Event is activated in a segment then it is not possible to set a User Value in that segment, see section 22.4.3.

### 22.4.2 Time Event

Digital events can simply be the turning on of a digital output for the duration of a segment. An extension of this is the Time Event. In this case the first digital event can have a delay (On Time) and an (Off Time) specified. 'On Time' defines when the digital output will turn on after the beginning of the segment and 'Off Time' defines when the digital output will turn off. The reference point for the On and Off times is the start of the segment.

- Only the first digital event may be configured as a Time Event.
- Each segment has one Time Event parameter (OFF, Event1).
- The first piano key is replaced by 'T' if a time event is configured (and is not alterable)

Editing of the Time Events follows a number of simple rules to make programming easier for the operator - These are shown in the diagrams below; assume On Time= **Ton**, Off Time= **Toff**

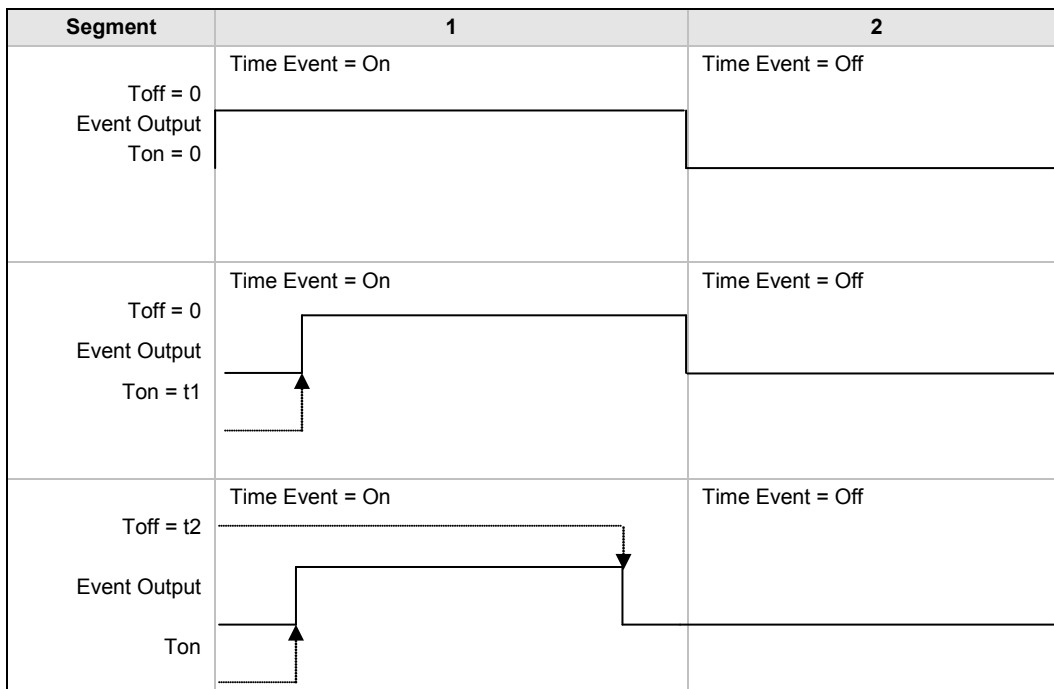

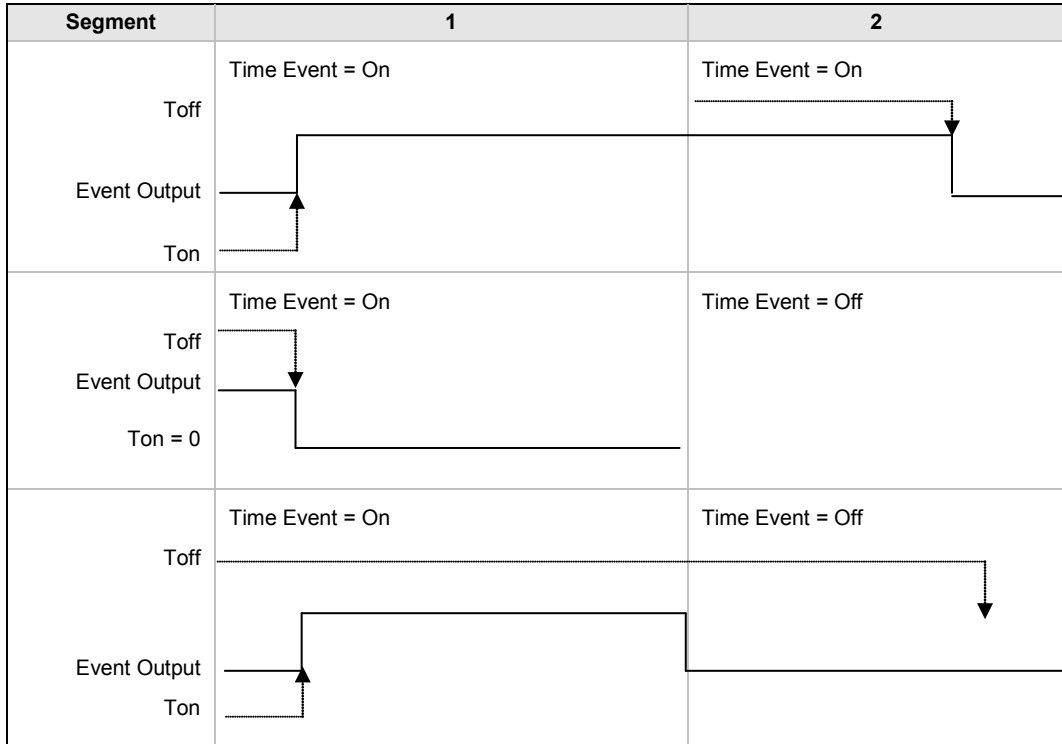

- To configure an event which straddles two segments configure Ton in Segment n and Toff in segment n+1.

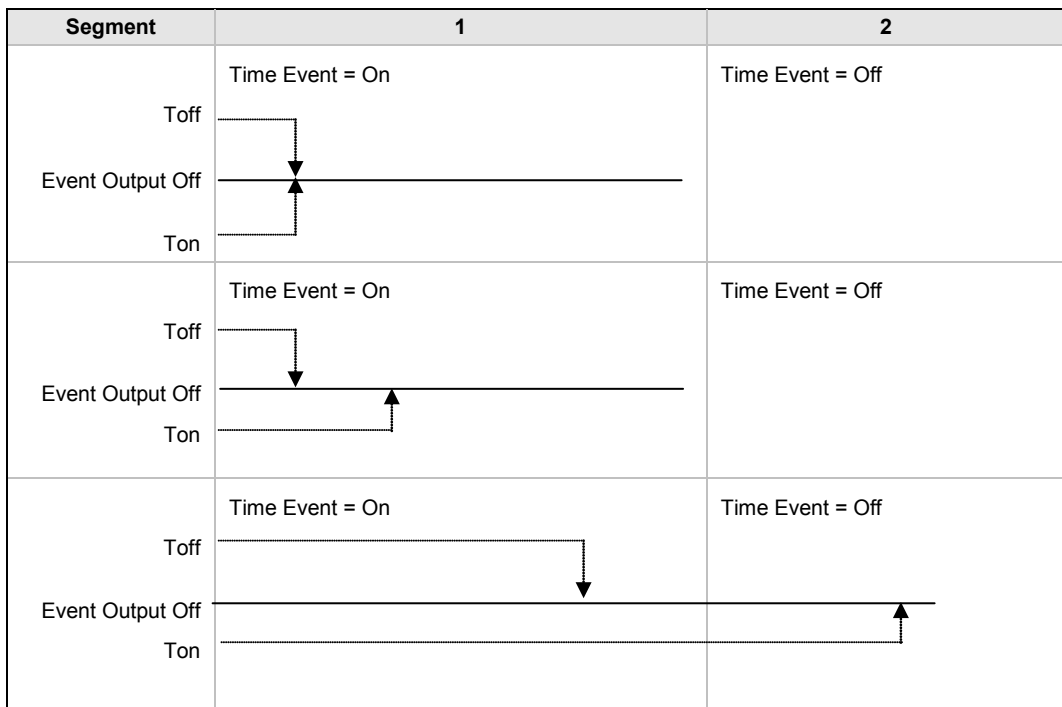

- Ton and Toff are extended by G.Soak periods. If Ton = 0, the output goes hi at the start of the segment but Toff is not decremented while Gsoak Wait is applied. Timed event outputs are on a total of Gsoak Wait + (Toff – Ton).

The following additional features are available in dual programmer versions:-

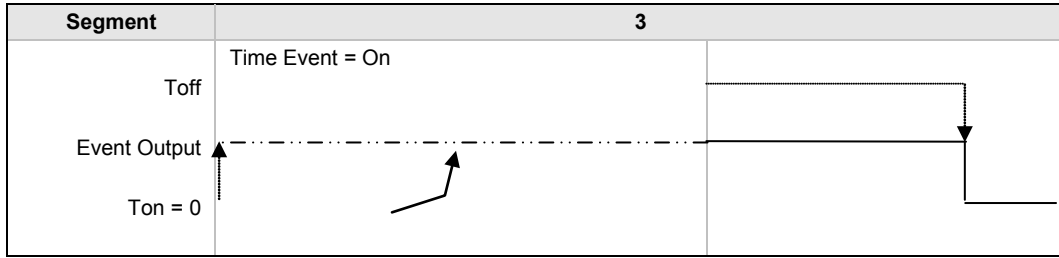

- When  $Ton > 0$ , Timed event is On after Gsoak Wait + Ton. This may be seen in the following diagram.

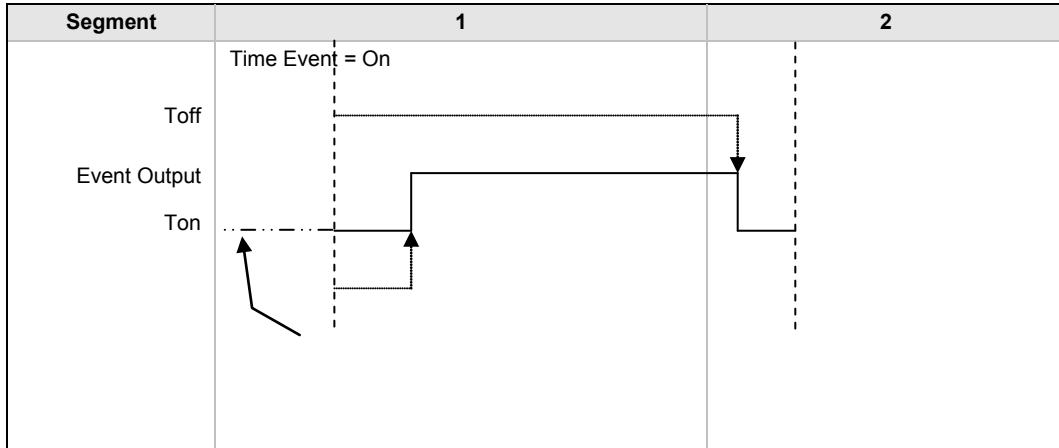

In the event of a power fail, time events timing will be unaffected.

### 22.4.3 User Values

User values are general purpose analogue values which may be set up in any Time, Rate, Dwell or Step segment provided a PV Event is not configured in that segment. When the segment is entered the analogue value is transferred to the 'UserValOP' parameter. This parameter may be wired to a source within the controller for use in a particular application dependent strategy. A different value may be set in each segment in which the 'UsrVal' is called up. One example of its use is to set different output powers in different segments by wiring the 'UserValOP' to the output power parameter.

Resolution for 'UsrVal' is derived from 'RstUVal'. To adjust resolution, software a 'user value' to 'RstUVal' and configure its resolution as required.

The User Value may be given a customised name using iTools configuration package as described in section 27.15.



## 22.5 Holdback

Holdback freezes the program if the process value (PV) does not track the setpoint (SP) by more than a user defined amount. The instrument will remain in HOLDBACK until the PV returns to within the requested deviation from setpoint. The display will flash the HOLD beacon.

In a **Ramp** it indicates that the PV is lagging the SP by more than the set amount and that the program is waiting for the process to catch up.

Holdback maintains the correct soak period for the product.

Each program can be configured with a holdback value. Each segment determines the holdback function.

Holdback will cause the execution time of the program to extend, if the process cannot match the demanded profile.

Holdback state will not change the user's access to the parameters. The parameters will behave as if in the RUN state.

The diagram below demonstrates that the demanded setpoint (SP) will only change at the rate specified by the program when the PV's deviation is less than the holdback value. When the Deviation between the setpoint and PV is greater than the holdback value (HBk Val) the setpoint ramp will pause until the deviation returns to within the band.

The next segment will not start until the deviation between Setpoint and PV is less than the holdback value.

Four types of Holdback are available:-

None	Holdback is disabled for this segment.
High	Holdback is entered when the PV is greater than the Setpoint <b>plus</b> HBk Val.
Low	Holdback is entered when the PV is lower than the Setpoint <b>minus</b> HBk Val.
Band	Holdback is entered when the PV is <b>either</b> greater than the Setpoint <b>plus</b> HBk Val <b>or</b> lower than the Setpoint <b>minus</b> HBk Val

### 22.5.1 Guaranteed Soak

Guaranteed Soak (guaranteed time work piece stays at SP within a specified tolerance) is achieved in the previous single programmer version by using Holdback Band during a dwell segment. Since only one holdback value per program is available, this imposes a limitation where different tolerance values are required to guarantee the soak.

In the software version 2 programmer (Including single channel), Holdback Type in Dwell segments is replaced by a Guaranteed Soak Type (G.Soak) which can be set as Off, Lo, Hi or Band. A Guaranteed Soak Value (G.Soak Val) is available in Dwell segments and this provides the ability to set different values in any Dwell segment.

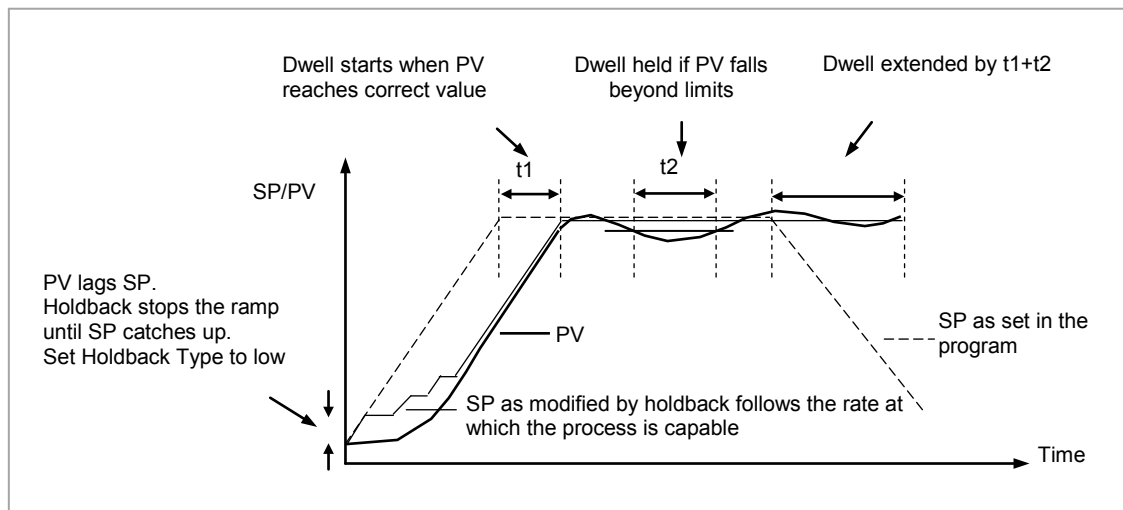

Figure 22-4: Effect of Guaranteed Soak

### 22.6 PID Select

It is possible to set up three sets of PID values, see Chapter 21. Any one of these sets may be activated in any segment of the program, except if the segment is configured as Wait, Goback or End. There are two parameters to configure. In the 'Program Setup' page configure the parameter 'PID Set?' to 'Yes'. In the 'Program Edit' page configure 'PID Set' to the most suitable set for the chosen segment. If 'PID Set?' = 'No' in the Program Setup page the choice of PID sets is not given in the segments.

The last PID set in the program (SET1 by default) will be applied during these segments. When reset the usual PID strategy for the loop takes over.

### 22.7 Sync Point – 'Goback' Interaction

Sync. points cause a segment in channel 1 to wait for a segment in Channel 2 and visa versa. To configure a Sync. Point the 'Wait For' parameter is set to 'Ch2Sync'. Several scenarios are possible which require clarification:

1) Channel 2 does not have a valid corresponding Go Back:

Channel 1 repeats segments 1 and 2, 11 times – the first time (prior to Go Back) the Sync. points are observed and evaluated as specified. During the Go Back however, as there are no Go Backs specified in channel 2, the Sync. points are ignored.

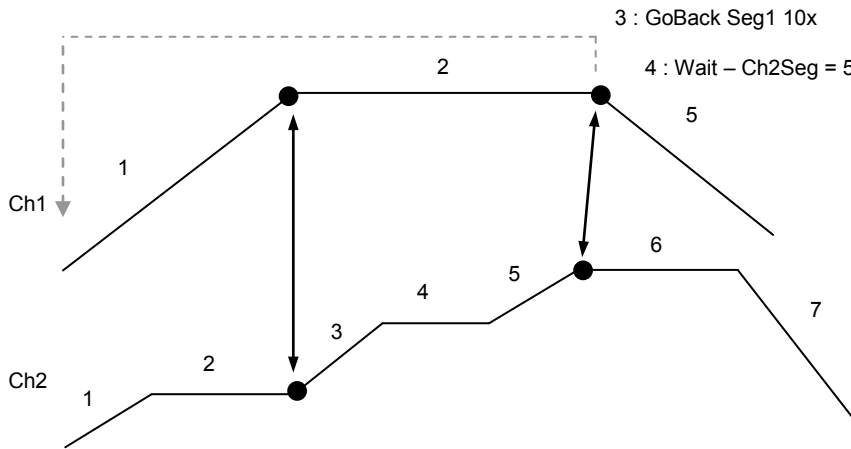

2) 'GoBack' in Channel 2 does not cover a sync. point :

In this scenario the first Sync. point is never covered during the 'GoBack' cycles in Channel 2; this Sync. point will therefore be ignored during the 'GoBack' cycles of Channel 1. The second Sync. point is covered for 5 'GoBack' cycles and therefore constitutes a valid Sync. point during the 5 cycles. During the remaining 'GoBack' cycles of Channel 1, Sync. point 2 will be ignored.

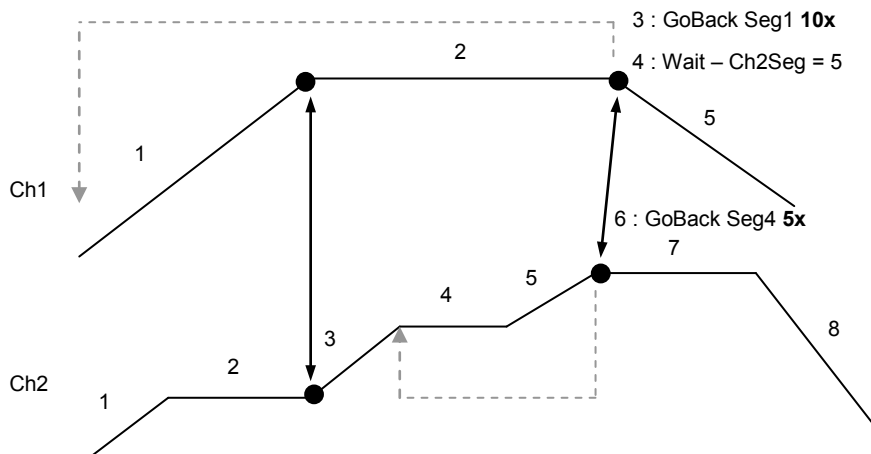

## 22.8 PrgIn1 and PrgIn2

These are events called Program Input 1 and 2 which can be wired to any parameter. They are used in 'wait' segments to prevent the program continuing until the event becomes true. Example 1 in section 22.17.5 shows how these might be used.

## 22.9 Program Cycles

If the Program Cycles parameter is chosen as greater than 1, the program will execute all of its segments (including calls to other programs) then repeat from the beginning. The number of cycles is determined by the parameter value. The Program Cycles parameter has a range of 0 to 9999 where 0 is enumerated to 'Cont' (continuous).

Program cycles apply to both channels. In the event that one channel completes a cycle before the second channel has finished the first channel will automatically wait until the second channel has completed. In other words there is an implied sync. point at the end of each cycle, so, channel 1 will wait for channel 2 (and visa versa) to complete the first cycle before progressing to the next.

## 22.10 Servo

Servo can be set in configuration so that when a program is run the setpoint can start from the initial controller setpoint or from the current process value. Whichever it is, the starting point is called the servo point. This can be set in the program.

Servo to PV will produce a smooth and bumpless start to the process.

Servo to SP may be used in a Ramp Rate programmer to guarantee the time period of the first segment.



**Note:** in a Time to Target programmer the segment duration will always be determined by the setting of the Segment Duration parameter.

### 22.11 Power Fail Recovery

In the event of power fail to the controller, a strategy may be set in configuration level, which defines how the controller behaves on restoration of the power. These strategies include:

Continue	The program setpoint returns immediately to its last value prior to the power down, then return to the target setpoint at the ramp rate set for that segment. This may cause full power to be applied to the process for a short period to heat the process back to its value prior to the power failure.
Ramp back	This will servo the program setpoint to the measured value (the PV Input parameter value), then return to the target setpoint at the ramp rate set for that segment or the last rate available if in a dwell segment. The setpoint is not allowed to step change the program setpoint. The outputs will take the state of the segment which was active before power was interrupted.
Reset	The process is aborted by resetting the program. All event outputs will take the reset state.
The display does not warn the operator that a power interruption has occurred.	

#### 22.11.1 Ramp back (Power fail during Dwell segments.)

If the interrupted segment was a Dwell, then the ramp rate will be determined by the previous ramp segment. On achieving the Dwell setpoint, the dwell will continue from the point at which the power was interrupted.

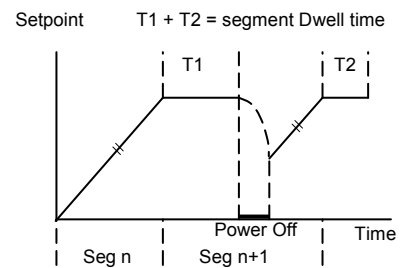

**Note:** If a previous ramp segment does not exist, i.e. the first segment of a program is a dwell, then the Dwell will continue at the "servo to PV" setpoint.

#### 22.11.2 Ramp back (power fail during Ramp segments)

If the interrupted segment was a ramp, then the programmer will servo the program setpoint to the PV, then ramp towards the target setpoint at the previous ramp rate. Previous ramp rate is the ramp rate at power fail.

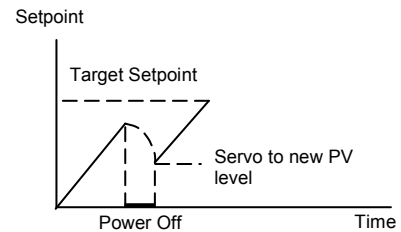

#### 22.12 Ramp back (power fail during Time-to-target segments)

If the programmer was defined as a Time-to-Target programmer then when the power is returned the previous ramp rate will be recovered. The Time remaining will be recalculated. The rule is to maintain RAMP RATE, but alter TIME REMAINING.

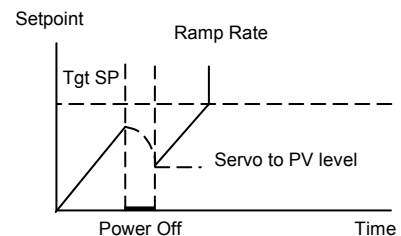

### 22.13 Sensor Break Recovery

On sensor break, the program state changed to HOLD if the current state is RUN or HOLDBACK. Sensor break is defined as status bad on the PV Input parameter. If the program state is in HOLD when PV input status returns to OK, the program state is automatically set back to RUN.

## 22.14 Operating a Program

The program may be operated from the RUN/HOLD button on the front of the controller or via digital inputs or via digital communications or via parameters found in the Program Setup lists.

### 22.14.1 Run

In run the programmer working setpoint varies in accordance with the profile set in the active program. A program will always run – non configured programs will default to a single Dwell end segment.

### 22.14.2 Reset

In reset the programmer is inactive and the controller behaves as a standard controller. It will:-

1. Continue to control with the setpoint determined by the next available source, SP1, SP2, Alternative Setpoint.
2. Allow edits to all segments
3. Return all controlled outputs to the configured reset state.

### 22.14.3 Hold

A programmer may only be placed in Hold from the Run or Holdback state. In hold the setpoint is frozen at the current programmer setpoint and the time remaining parameter frozen at its last value. In this state you can make temporary changes to program parameters such as a target setpoint, ramp rates and times. These changes will only remain effective until the end of the currently running segment, when they will be overwritten by the stored program values.

### 22.14.4 Skip Segment

This is a parameter found in the Program Setup List, section 22.16. It moves immediately to the next segment and starts the segment from the current setpoint value.

### 22.14.5 Advance Segment

This is a parameter found in the Program Setup List, section 22.16. It sets the program setpoint equal to the target setpoint and moves to the next segment.

### 22.14.6 Fast

Executes the program at 10x the normal speed. It is provided so that programs can be tested **but the process should not be run in this state.**

Fast is only available in Level 3.

**22.14.7 Run/Hold/Reset Digital Inputs**

The dual programmer and the single programmer available in version 1 software can have Run, Hold and Reset wired, for example, to three digital inputs so that these functions can operate the program externally. The software version 2 programmer has in addition Run/Reset and Run/Hold parameters which can provide the same functions via two digital inputs. Hold/Run may be implemented by inverting the Run/Hold input (Hold will only work if already in Run state). The triggering actions are as follows:-

**22.14.7.1 Run/Reset**

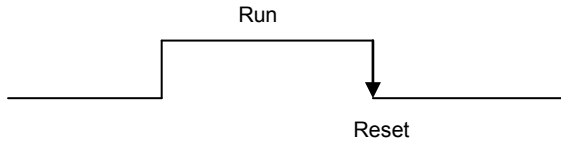

Hold or Reset can also be operated from the user interface when in Run

**22.14.7.2 Run/Hold**

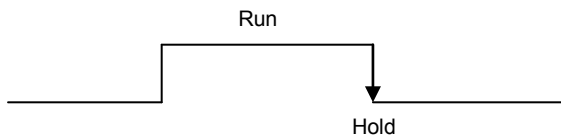

The program can be Reset from the user interface when in Run or Hold.

**22.14.7.3 Hold/Run**

- Invert the Run/Hold input for Hold/Run functionality shown below.

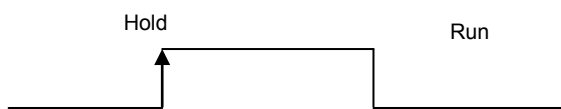

Only go into Hold if previously in Run. It will be possible to Reset from the user interface when in Hold or Run.

For a SynAll and SyncStart programmer the digital inputs are used to control BOTH program channels.

## 22.15 PV Start

When Run is initiated PV start (for each channel) allows the program to automatically advance to the correct point in the profile which corresponds to the current PV. For example, if the process is already at PV3 when run is initiated then the program will start from the third segment as shown in the diagram below.

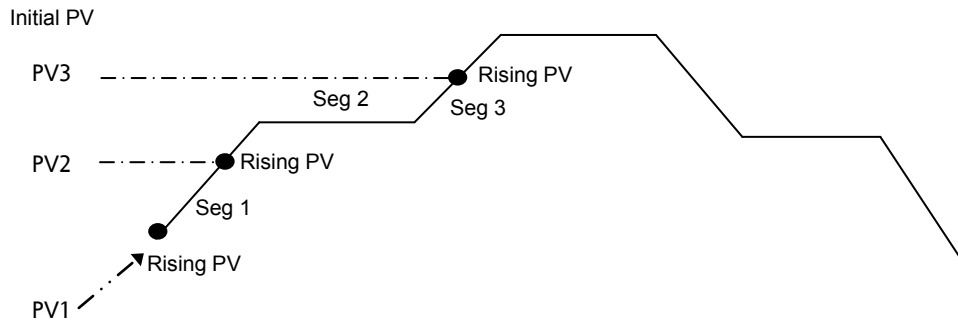

The user may specify the start point based on a Rising PV as shown in the diagram above or on a Falling PV as shown below depending on type of profile being run.

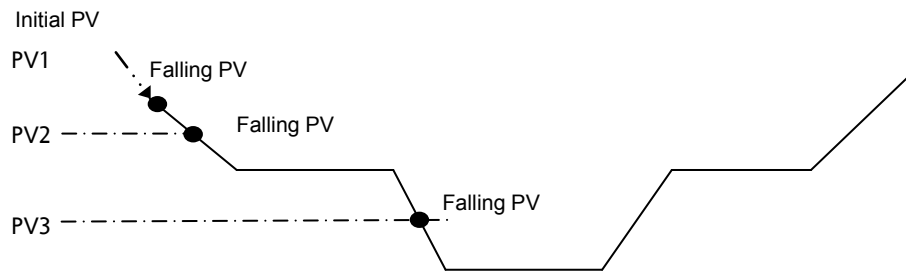







When PV Start is used, the program always servos to PV (i.e. servo to SP will be ignored).

In a 'SyncAll' programmer, 'PVStart' is only configurable in channel 1. Channel 2 will also servo to PV in the segment determined for PVStart by channel 1. In such cases, Channel 1 PSP and Channel 2 PSP may reach the end of segment at different times, but 'Sync' will take place prior to execution of the next segment.



**22.15.1 Example: To Run, Hold or Reset a Program**

When the controller is ordered as a programmer a Programmer Summary screen is available in operator mode which allows quick access to the programmer.

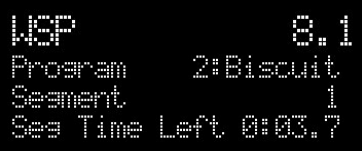
The example below uses this screen.

Do This	The Display You Should See	Additional Notes
1. From any display press  until the 'Programmer User Display' is shown		
2. Press  to 'Program' 3. Press  or  to choose the program number to be run		In this example Program Number 2 is chosen and has been given a user defined name. In the 3504 Program names can be entered using the off-line programming package 'iTools'.
4. Press RUN/HOLD button or select 'Status' and set this to 'Run'. A pop up is displayed where the program number may be selected prior to run.		'RUN' is displayed in the indicator beacons section of the main display. The view shown here shows current working setpoint, program being run, current segment number and time left to complete this segment.
5. To Hold a program press RUN/HOLD button		Press RUN/HOLD button again to continue the program. When the program is complete 'RUN' will flash
6. To Reset a program press RUN/HOLD button for at least 3 seconds		'RUN' will extinguish and the controller will return to the HOME display shown in section 2.3.

**Notes:**



- 1. An alternative way to run, hold or reset the program from this screen, is to scroll to 'Program Status' using  and select 'Run', 'Hold' or 'Reset' using  or 
- 2. If the program number has been previously selected the program can be run, held or reset just by pressing the RUN/HOLD button



## 22.16 Program Set Up

Parameters in the '**Program Setup**' page allow you to configure and view parameters common to all programs for both program channels 1 and 2. This page of parameters is only available in configuration level. Press  as many times as necessary to select the '**Program Setup**' page.

The following table lists parameters available.

List Header – Program Setup		Sub-header: Ch1 or Ch2			
Name  to select	Parameter Description	Value Press  or  to change values		Default	Access Level
Channel	To select program channel 1 or 2 (Not shown in Single Channel programmer)	Ch1	Program channel 1		Conf
		Ch2	Program channel 2		
Units	This parameter will adopt the units of the parameter to which the programmer 'PVIn' is wired. For example, Programmer 'PVIn' could be wired to 'Loop TrackSP' and 'Loop MainPV' wired to 'PVInput'. The units will adopt the units set in PVInput list.	See display units list, section 7.2.3.			R/O Alterable if not wired
Resolution	As units the resolution is set by the parameter it is wired to.	XXXXX to X.XXX.X			R/O Alterable if not wired
PV Input	The programmer uses the PV input for a number of functions In holdback, the PV is monitored against the setpoint, and if a deviation occurs the program is paused. The programmer can be configured to start its profile from the current PV value (servo to PV). The programmer monitors the PV value for Sensor Break. The programmer holds in sensor break. The 'PVStart' feature uses the PV value to search for the segment in which the program starts.	The PV Input is normally wired from the loop TrackPV parameter. Note that this input is automatically wired when the programmer and loop are enabled and there are no existing wires to track interface parameters. Track interface parameters are Programmer.Setup, PVInput, SPInput, Loop.SP, AltSP, Loop.SP, AltSPSelect.			Conf
SP Input	The programmer needs to know the working setpoint of the loop it is trying to control. The SP input is used in the servo to setpoint start type. Note that SP Input is normally wired from the loop Track SP parameter	SP Input is normally wired from the loop Track SP parameter as the PV input.			Conf
Servo	The programmer may be configured to start from either the PV or the working setpoint. See also section 22.10.	PV	Start program from current PV value.		Conf
		SP	Start program from the current working setpoint. If the program has been configured to use PVStart (start from the segment in which the PV resides), servo to SP will be ignored.		
Power Fail	Power fail recovery strategy See also section 22.11.	Ramp	Ramp back to program setpoint at the previous ramp rate		Conf
		Reset	Reset program		
		Cont	Continue program		
Rate Res	Configures the display resolution of ramp rates (see Program Edit page). (Not Shown for SyncAll programmer)	XXXX.X to X.XXXX			Conf

List Header – Program Setup		Sub-header: Ch1 or Ch2			
Max Events	To set the maximum number of output events required for the program. This is for convenience to avoid having to scroll through unwanted events when setting up each segment	1 to 8			Conf
PVEvent?	Enable PV Event provides an alarm facility on Programmer's 'PVInput'. PV Event Type and Threshold are defined in each Segment.	No		No	Conf
		Yes	PV Event parameters are listed in the Program Edit page.		
TimeEvent?	Enables the first Event Output to be configured as a Time Event - each segment may then specify an on and an off time, with respect to the start of the segment, for the event.	No		No	Conf
		Yes	Time Event parameters are listed in the Program Edit page		
UserVal?	Enables a single analogue value to be set in every segment. It is only available if 'Ch1/Ch2PV Event' = 'None' in the Program Edit page.	No	User value not shown	No	Conf
		Yes	User value shown in every segment		
Gsoak?	Enable Guaranteed soak ensures that the work piece remains at the specified dwell setpoint for a minimum of the specified duration. This parameter is only shown for SyncStart programmers	No	No guaranteed	No	Conf
		Yes	Guaranteed soak parameters are listed in the Program Edit page for all Dwell segments.		
DelayedStart?	Enables a time period to be set between starting Run and the program actually running	No	The program will run immediately	No	Conf
		Yes	Delayed start is listed in the Program Status page. It is also listed in the pop up associated with the RUN/HOLD key.		
PID Set?	Enables PID set. The setting configured in each segment will automatically select the relevant PID Set for the loop wired to the Programmer. Upon completion of the program, PID setting of the loop will be reset to values prior to execution of the program See also section 22.6.	No	PID control is under the control of loop settings	No	Conf
		Yes	PID Set is listed in the Program Edit page.		
Prog Reset	Program reset is provided so that it may be wired from digital inputs to reset the program. RESET is an INPUT only. The Program is held in RESET while the reset input is TRUE	No/Yes	Can be wired to logic inputs to provide remote program control		R/O
Prog Run	Program run is an input to the programmer. When it is switched from False (0) to True (1) the programmer runs its program. ☺ Reset will override this input. At the end of a program, the Program will not re-run until Program Run has been set to False and back to True.	No/Yes			R/O
Prog Hold	Holds the program while the input is true. ☺ Reset overrides this input.	No/Yes			R/O
Prog RunHold	Program Run Hold is an input to the programmer. While it is in the True (1) state, it runs the program. When it is switched from True(1) to False (0) the programmer Holds its program. ☺ Reset overrides this input in all states. Hold overrides this input when in Run state. At the end of a program, the Program will not re-run until Program Run Hold has been set to False and back to True.	No/Yes	These parameters can be wired to provide a Run/Hold facility. See section 22.14.7.		R/O



List Header – Program Setup		Sub-header: Ch1 or Ch2			
Prog RunReset	<p>Program Run Reset is an input to the programmer. While it is in the True (1) state, it runs the program. When it is switched from True(1) to False (0) the programmer Resets its program.</p> <p>☺ Reset and Hold will override this input when in Run state.</p> <p>At the end of a program, the Program will not re-run until Program Run Reset has been set to False and back to True.</p>	No/Yes			R/O
Advance	Set the program setpoint equal to the target setpoint and advance to the next segment.	No	Ignore	No	Conf
		Yes	Go to next segment		
SkipSeg	Skip to the next segment and start the segment at the current program setpoint value.	No	Ignore	No	Conf
		Yes	Go to next segment		
Event 1 to 8	Outputs showing event states	On Off			R/O
End of Seg	Flag showing end of segment state	On Off			R/O
PVEventOP	Provides an output for the PV event which can be wired for use in a control strategy (Only shown if 'PVEvent?' = Yes)	Off On			R/O
UserValOP	This is a wireable parameter which adopts the value set by 'Usr Val' in the Programmer Status list available in operator levels. In segments that specify 'PVEvent' 'UserValOP' is set to this value. (Only shown if 'UserVal?' = Yes)	0.0			R/O
Sync Input	<p>On a Dual Loop Instrument synchronised start is achieved by wiring the Sync1 output from the master Programmer to the SyncIP of the slave Programmer - see Sync1 for further details</p> <p>The synchronise input may also be used to synchronise programs executed on different instruments. At the end of a segment the programmer will inspect the sync. input, if it is True (1) then the programmer will advance to the next segment. It is typically wired from the end of segment output of another programmer.</p>	0 1			Conf
Sync1	<p>Synchronised start is achieved by wiring the 'Sync1' output from the Master channel (P1) to 'SyncIn' of the Slave channel (P2). Program control is then fully transferred to the Master channel where the program number is selected and Run/Hold/Reset commands executed. This link is shown graphically in section 27.10.</p> <p>By default the 3500 is supplied so that both programs run together.</p>				
PrgIn1	These are events called Program Input 1 and 2 and can be wired to any parameter. They may be used in a 'wait' segment to prevent the program continuing until the event becomes true	Off			Conf
PrgIn2		On			
PVWaitIP	<p>PV wait input for a wait segment.</p> <p>This analogue input may be used to stop the execution of the next segment.</p> <p>This is achieved by using a Wait Segment, and selecting 'PVWaitIP' for the Wait For parameter.</p> <p>PV Wait may then be configured as appropriate to determine the criterion for waiting - see 'Ch1 (Ch2) PV Wait' in the Program Edit page for further details.</p>	Range units			Conf

List Header – Program Setup		Sub-header: Ch1 or Ch2			
ProgError	Provides messages if an invalid entry is made to a program. The message appears in the form of a pop up on the controller display or as a message over digital communications.	0: No Error			
		1: Sensor Break	Due to sensor break, it is not possible to run the program.. Source of the sensor break is the PV Input to the Programmer block.		
		2: Empty Program	Program currently selected for execution has no segments		
		3: Over Range	Program currently selected for execution contains setpoints that reside outside the loop setpoint limits.		

## 22.17 Program Edit

To set up or edit a program, use the parameters in the 'Program Edit' lists. Parameters are similar for each programmer type but are listed individually here for clarity. Use of  button will provide a short cut to the Program Status page in operator levels and Program Setup page in configuration level.



### 22.17.1 To Edit a SyncAll Programmer

Select the program number to be created or edited. (Press  followed by  or .

Programs can be created and edited in all levels.



This gives access to parameters which allow you to set up each segment of the selected program.

The following table lists these parameters:-

List Header – Program Edit (Sync All)		Sub-header: 1 to 50. These may also have user defined program names			
Name  to select	Parameter Description	Value Press  or  to change values		Default	Access Level
Program	Program number or program name (If configured)	1 to 50			L3
Segments Used	This value automatically increments when another segment is added	1 to 50		1	R/O
Ch1PVStart	PV Start determines the starting point for program channel 1. See also section 22.15.	Off			L3
		Rising			
		Falling			
Ch2PVStart	PV Start determines the starting point for program channel 2. See also section 22.15.	Off			L3
		Rising			
		Falling			
Ch1HldBk Value	Channel 1 holdback value. Sets the deviation between SP and PV at which holdback is applied to programmer channel 1. This value applies to the whole program. This parameter only appears if	Minimum setting 0			L3
Ch2HldBk Value	Channel 2 holdback value. Sets the deviation between SP and PV at which holdback is applied to programmer channel 2. This value applies to the whole program.	Minimum setting 0			L3
Cycles	Number of times the whole program repeats	Cont 1 to 9999	Repeats continuously Program executes once to 9999 times		L3
Segment	To select the segment to set up	1 to 50			L3
Segment Type	To define the type of segment. See also section 22.3.	End	Last segment in the program	End	L3
		Time	Time duration of the segment		
		Wait	Wait for event before progressing to the next segment		
		GoBack	Go back to a previous segment and repeat. See section 22.3.5.		
If 'Segment Type' = 'Time' the following parameters are shown.					
Ch1 Target SP	The setpoint value required in program channel 1 at the end of the selected segment	Within the setpoint limits			L3
Ch2 Target SP	The setpoint value required in program channel 2 at the end of the selected segment	Within the setpoint limits			L3
Duration	Sets the time to execute the segment.	0:00:00 to 500:00 1 sec to 500 hours			L3



List Header – Program Edit (Sync All)		Sub-header: 1 to 50. These may also have user defined program names			
Name ⌚ to select	Parameter Description	Value Press ⏴ or ⏵ to change values		Default	Access Level
Ch1 Hldbck Type	Sets the type of holdback applicable to the selected segment in program channel 1	Off	No holdback applied		L3
		Low	Deviation low		
Ch2 Hldbck Type	Sets the type of holdback applicable to the selected segment in program channel 2	High	Deviation high		L3
		Band	Deviation high and low		
Ch1 PV Event	PV Event provides an alarm facility on the main PV in Ch1. Each segment may be configured with an independent threshold value and alarm type. 'PVEventOP' is set accordingly in each segment to indicate the state of the PV Event  See also section 22.4	None	No PV event in this segment	None	L3
		Abs Hi	Event is triggered when the PV becomes greater than the threshold.		
		Abs Lo	Event is triggered when the PV becomes less than the threshold.		
		Dev Hi	Event is triggered when the PV becomes higher than the program setpoint by the amount of the threshold.		
		Dev Lo	Event is triggered when the PV becomes lower than the program setpoint by the amount of the threshold.		
		Band	Event is triggered when the PV differs from the program setpoint by the amount of the threshold.		
Ch1 PV Thresh	Channel 1 PV threshold. This only appears if 'Ch1 PV Event' ≠ None. It sets the trip level at which the event is true	Range limits		0.0	L3
Time Event	The first Event Output may be switched on and off under program control. See also section 22.4.2.	Off		Off	L3
		Event 1			
On Time	Time at which the 'Time Event' is true. Only appears if 'Time Event' ≠ Off See section 22.4.2 for error conditions	0:00:00 to 500.00		0:00:00	L3
Off Time	Time at which the 'Time Event' is false. Only appears if 'Time Event' ≠ Off See section 22.4.2 for error conditions	0:00:00 to 500.00		0:00:00	L3
UsrVal	General purpose user value, only available when PV Event is not configured. this parameter may be given a customised name, see section 27.12.14.  ☺ a Reset User Value may be set in the Programmer Status page in operator level.	Range limits. Resolution for 'UsrVal' is derived from 'RstUVal'. To adjust resolution, software a 'user value' to 'RstUVal' and configure its resolution as required.		0.0	L3
PID Set	PID Set allows automatic selection of the PID Set (scheduling) used by the loop wired to the	Set1	PID set 1	Set1	L3
		Set2	PID set 2		

List Header – Program Edit (Sync All)		Sub-header: 1 to 50. These may also have user defined program names			
Name ⌚ to select	Parameter Description	Value Press ⏴ or ⏵ to change values		Default	Access Level
	programmer for the selected segment. The PID parameters for each set are defined by the loop. Each segment stores a PIDSet number which is applied to the loop as the program progresses.	Set3	PID set 3		
End Type	Only shown if 'Segment Type' = End. Defines the action to be taken at the end of the program	Dwell	The program will remain at last SP indefinitely	Dwell	L3
		Reset	The program will return to controller only mode		
		SafeOP	The output value goes to a predefined level. The value is set in the list LP – OP see chapter 21.		
Event Outs	To define the state of up to eight event outputs in the selected segment □□□□□□□□ to ■■■■■■■■ or T□□□□□□□□ to ■■■■■■■■ T = Time event: □ = event off; ■ = event on	<input type="checkbox"/>	Off	<input type="checkbox"/>	L3
		<input checked="" type="checkbox"/>	On		
		T	Time event. This will be shown in the first event only when 'Time Event = Event 1'. See section 22.4.2		

List Header – Program Edit (Sync All)		Sub-header: 1 to 50. These may also have user defined program names			
On the next press of  the next 'Segment' is selected.					
If 'Segment Type' = 'Wait' the following parameter is shown.					
Wait For	Allows you to select the condition to become true before proceeding	PrgIn1	Wait until input 1 is true		L3
		PrgIn2	Wait until input 2 is true		
		PrgIn1n2	Wait until input 1 AND input 2 is true		
		PrgIn1or2	Wait until input 1 OR input 2 is true		
		PVWaitIP	Wait segment concludes when 'PVWaitIP' satisfies criterion specified by 'ChX PV Wait' - this option is used to Wait Until a specified value has been reached by 'PVWaitIP'.		
The following two or four parameters are shown if 'Wait For' = 'PVWaitIP'					
Ch1 PV Wait also Ch2 PV Wait	Configures the type of analogue event to be applied to the PVWaitIP parameter for the selected channel. See section 22.17.5.2 for an example.	None	No alarm type applied	None	L3
		Abs Hi	Absolute high		
		Abs Lo	Absolute low		
		Dev Hi	Deviation high		
		Dev Lo	Deviation low		
		Dev Band	Deviation band		
Ch1 Wait Val also Ch2 Wait Val	This sets the value at which the 'Ch1/2 PV Wait' parameter becomes active. It is not shown if 'Ch1/2 PV Wait' = 'None'	Range units		0	L3
On the next press of  the next 'Segment' is selected.					
If 'Segment Type' = 'GoBack' the following two parameters are shown					
GoBack Seg	This is shown if 'Segment Type' = 'GoBack'. It defines the segment to go back to.	1 to the number of segments defined			L3
GoBack Cycles	To set the number of times the section of the program is repeated. See section 22.3.5	1 to 999		1	L3
On the next press of  the next 'Segment' is selected.					







### 22.17.2 To Edit a Syncstart Programmer

Select the program number to be created or edited. (Press  followed by  or .

Programs can be created and edited in all levels.

This gives access to parameters which allow you to set up each segment of the selected program.

The following table lists these parameters:-

List Header – Program Edit (Sync Start)		Sub-header: 1 to 50. These may also have user defined program names			
Name  to select	Parameter Description	Value Press  or  to change values		Default	Access Level
Prg 1 or 2	Program number or program name (If configured) It is also possible to toggle between Ch1 and Ch2 programs using  . See note 1.	1 to 50			L3
Segments Used	This value automatically increments when another segment is added	1 to 50		1	R/O
PV Start	PV Start determines the starting point for program channel 1. See also section 22.15.	Off Rising Falling		Off	L3
Holdback Value	Value at which holdback is applied in those segments where Holdback Type is configured. It is deviation between SP and PV. See also section 22.5	Range units		0	L3
Ramp Units	Time unit applied to the segment	Sec Min Hour	Seconds Minutes Hours		L3
Cycles	Number of times the whole program repeats	Cont 1 to 9999	Repeats continuously Program executes once to 9999 times		L3
Segment	To select the segment to set up. A segment number can only be selected for editing after a segment type has been configured.	1 to 50			L3
Segment Type	To define the type of segment. See also section 22.3.	End Rate Time Dwell Step Wait GoBack	Last segment in the program Rate of change of SP Time duration of the segment Duration at previous SP Immediate change to new SP Wait for event before progressing to the next segment Go back to a previous segment and repeat. See section 22.3.5.	End	L3
Target SP	To set the desired setpoint value at the end of the segment. This appears for Rate, Time or Step segment types	Range units			L3
Ramp Rate	To set the rate of change of setpoint. This only appears if 'Segment Type' = 'Rate'	Units/time			L3
Duration	Only appears if 'Segment Type' = Dwell or Time. It sets the length of the dwell period	0:00:00 to 500.0		0:00:00	L3
Holdback Type	Sets the deviation between SP and PV at which holdback is applied to programmer	Off	No holdback applied to the segment		L3



List Header – Program Edit (Sync Start)		Sub-header: 1 to 50. These may also have user defined program names			
Name ⌚ to select	Parameter Description	Value Press ⏴ or ⏵ to change values		Default	Access Level
	channel 2. The value is set by 'Holdback Value' and applies to the whole program.	Low	Holdback is applied when PV<SP by the Holdback Value		
		High	Holdback is applied when PV>SP by the Holdback Value		
		Band	Holdback is applied when PV<>SP by the Holdback Value		
PV Event	Only appears if 'PVEvent?' in the Program Setup table = 'Yes'. It is also not shown if 'Segment Type' = 'Wait', 'GoBack' or 'End'. See also section 22.4.1	None	No PV event	None	L3
		Abs Hi	Absolute high		
		Abs Lo	Absolute low		
		Dev Hi	Deviation high		
		Dev Lo	Deviation low		
		Dev Band	Deviation band		
PV Threshold	Only appears when a PV Event is configured. sets the level at which the PV event becomes active	Range units		0	L3
Time Event	To set the type of time event applicable in the selected segment for program channel 2. Only appears if 'TimeEvent?' in the Program Setup table = 'Yes' See also section 22.4.2.	Off	No time event configured	Off	L3
		Event1	Event 1 configured as a time event		
On Time	Time wrt the start of the segment at which the event is true. Only appears if 'Time Event' ≠ Off See section 22.4.2 for error conditions.	0:00:00 to 500.00		0:00:00	L3
Off Time	Time wrt the start of the segment at which the event is false. Only appears if 'Time Event' ≠ Off See section 22.4.2 for error conditions.	0:00:00 to 500.00		0:00:00	L3
UsrVal	General purpose user value, only available when PV Event is not configured. this parameter may be given a customised name, see section 27.12.14 ⌚ a Reset User Value may be set in the Programmer Status page in operator level.	Range limits. Resolution for 'UsrVal' is derived from 'RstUVal'. To adjust resolution, software a 'user value' to 'RstUVal' and configure its resolution as required.			L3
PID Set	To select the PID set for the selected segment	Set1 Set2 Set3	PID set 1, 2 or 3 will be used in the selected segment	Set1	L3
GSoak Type	This parameter is only shown if the 'Segment Type' = 'Dwell' and 'Gsoak?' is enabled in the Program SetUp page. If the PV deviates by more than an amount set by the 'G. Soak Value' then the program will be put into hold until the deviation becomes less than G. Soak Value. See also section 22.5.1	Off	No guaranteed soak applied	Off	L3
		Low	Program is held if PV<SP+G.Soak Value		
		High	Program is held if PV>SP+G.Soak Value		
		Band	Program is held if PV<>SP+G.Soak Value		
G. Soak Value	Sets the value for the guaranteed soak	Range units			L3
If 'Segment Type' = 'GoBack' the following two parameters are shown					
GoBack Seg	This is shown if 'Segment Type' = 'GoBack'. It defines the segment to go back to.	1 to the number of segments defined			L3

List Header – Program Edit (Sync Start)		Sub-header: 1 to 50. These may also have user defined program names			
Name ⌚ to select	Parameter Description	Value Press ⏴ or ⏵ to change values	Default	Access Level	
GoBack Cycles	To set the number of times the section of the program is repeated. See section 22.3.5	1 to 999	1	L3	
If 'Segment Type' = 'Wait' the following parameter is shown					
Wait For	Only appears if 'Segment Type' = 'Wait'. It allows you to select the event to become true before proceeding	PrgIn1 PrgIn2 PrgIn1n2 PrgIn1or2 PVWaitIP Ch2Sync	Wait for the program event 1 Wait for the program event 2 Wait for the program event 1 AND 2 Wait for the program event 1 OR 2 Wait segment concludes when 'PVWaitIP' satisfies criterion specified by 'ChX PV Wait' - this option is used to Wait Until a specified value has been reached by 'PVWaitIP' In SyncStart mode, the two channels of a program start simultaneously but will end as and when prescribed by their respective profiles. Select 'Ch2Sync' to specify points in the program where the two channels must wait for completion of the segment in BOTH channels (synchronise) before moving on. Only offered in channel 1, where 'Ch2Seg' specifies the synchronisation segment.		L3
The following two parameters are shown if 'Wait For' = 'PVWaitIP'					
PV Wait	Configures the type of analogue event to be applied to the PVWaitIP parameter for the selected channel	None Abs Hi Abs Lo Dev Hi Dev Lo Dev Band	No alarm type applied Absolute high Absolute low Deviation high Deviation low Deviation band	None	L3
WaitVal	This sets the value at which the 'Ch1/2 PV Wait' parameter becomes active. It is not shown if 'Ch1/2 PV Wait' = 'None'	Range units		0	L3
The following parameter is shown if 'Wait For' = 'Ch2Sync'					
Ch2Seg	Defines the channel 2 segment to wait for. Ch2Seg values must be consecutive in any program, e.g. if Ch1Seg1 is set to wait for Ch2Seg3 followed by a further wait in Ch1Seg2 then the segment to wait for in Ch2 must be >3.	1 to 50		1	L3

List Header – Program Edit (Sync Start)		Sub-header: 1 to 50. These may also have user defined program names			
Name ⌚ to select	Parameter Description	Value Press ⏴ or ⏵ to change values	Default	Access Level	
The following parameter is shown if the 'Segment Type' = 'End'					
End Type	Only shown if 'Segment Type' = End. Defines the action to be taken at the end of the program	Dwell  SafeOP  Reset	The program will remain at last SP indefinitely  The output value goes to a predefined level. The value is set in the list LP – OP see chapter 21  The program will return to controller only mode	Dwell	L3
Event Outs	To define the state of up to eight event outputs in the selected segment □□□□□□□□ to ■■■■■■■■ or T□□□□□□□ to ■■■■■■■■ T = Time event: □ = event off; ■ = event on	□ ■ T	Off On Time event. This will be shown in the first event only when 'Time Event = Event 1'. See section 22.4.2	□	L3

**Note 1:** When setting up segments in Ch1 and Ch2 you may either set up the same segment, first in Ch1 then in Ch2, in which case use  to switch between the two programmer channels. Alternatively, you may wish to set up all segments in Ch1 then all segments in Ch2.

**22.17.3 Summary of Parameters which appear for different Segment Types**

Pressing  will scroll through the parameters listed in the above table. When the last parameter in a segment is configured the next press of  will take you to the next segment number. This will always be an 'End' segment until it is configured differently. The following table shows a summary of the parameters which appear for different 'Segment Types' (For this summary it is assumed that Holdback Type, PV Event, and Time Event are set to Off.

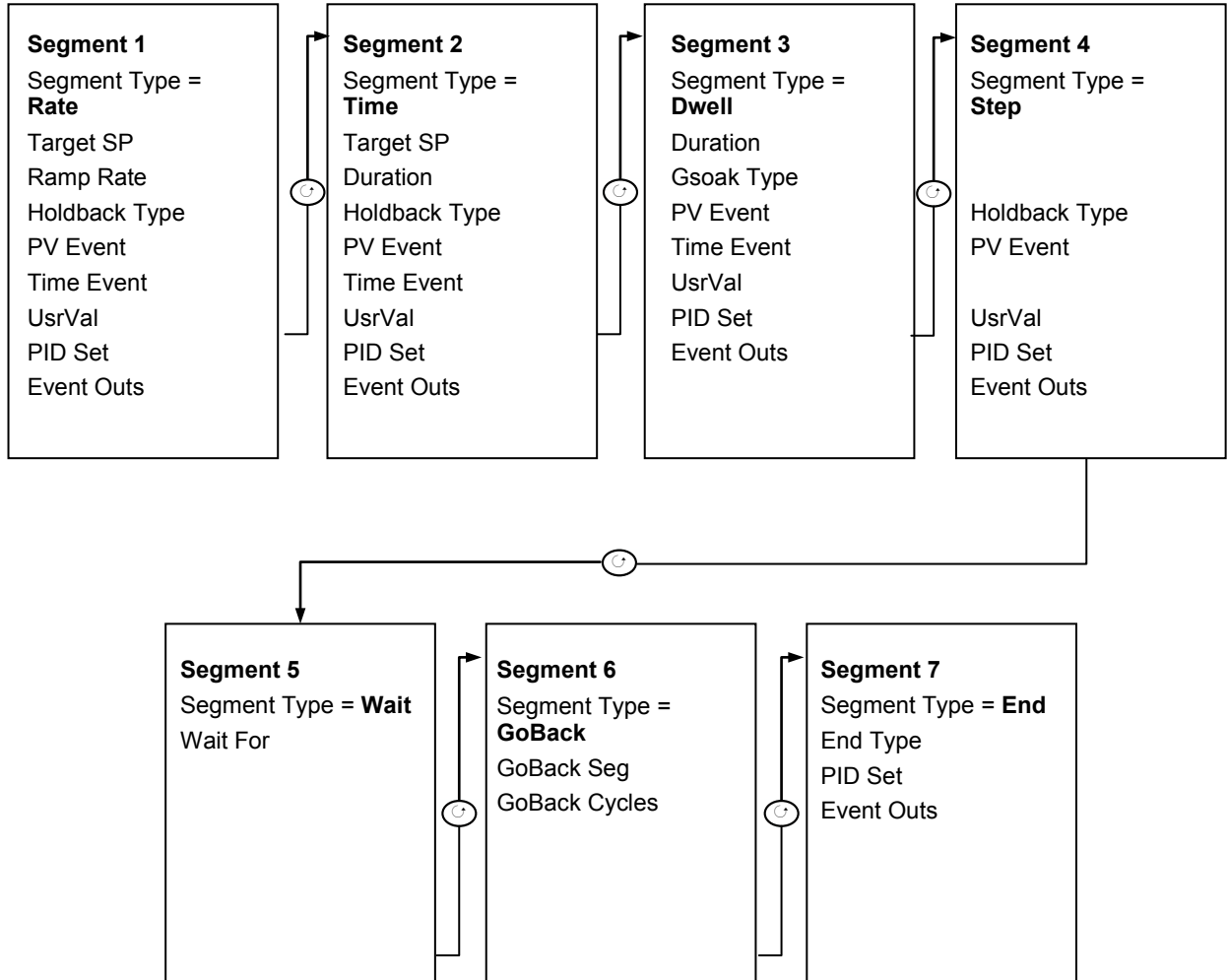

#### 22.17.4 To Edit a Single Channel Programmer

By default, when the program is configured as a Single Programmer in the 'Inst Opt' page, only programmer channel 1 can be run.

The parameters shown in the following table apply and are as follows:-

List Header – Program Edit		Sub-header: 1 to 50. These may also have user defined program names			
Name ⊙ to select	Parameter Description	Value Press ▼ or ▲ to change values		Default	Access Level
Program	Program number or program name (If configured)	1 to 50			L3
Segments Used	This value automatically increments when another segment is added	1 to 50		1	R/O
Holdback Value	Allows a value to be entered to activate 'Holdback'.				L3
Ramp Units	Time unit applied to the segment	Sec Min Hour	Seconds Minutes Hours	Sec	L3
Cycles	Number of times the whole program repeats	Cont 1 to 9999	Repeats continuously Program executes once to 9999 times		L3
Segment	To select the segment to set up. A segment number can only be selected for editing after a segment type has been configured.	1 to 50			L3
Segment Type	To define the type of segment. See also section 22.3	End Rate Time Dwell Step Wait GoBack Call	Last segment in the program Rate of change of SP Time duration of the segment Duration at previous SP Immediate change to new SP Wait for event before progressing to the next segment Go back to a previous segment and repeat. See section 22.3.5 To insert a new program into the current program. See section 22.3.7	End	L3
Target SP	To set the desired setpoint value at the end of the segment. This appears for Rate, Time or Step segment types	Range units			L3
Ramp Rate	To set the rate of change of setpoint. This only appears if 'Segment Type' = 'Rate'	Units/time			L3
Duration	Only appears if 'Segment Type' = Dwell or Time. It sets the length of the dwell period	0:00:00 to 500.0		0:00:00	L3
Holdback Type	Defines the type of holdback to be applied to the segment. See section 22.5.	Off Low High Band	No holdback applied to the segment Holdback is applied when PV<SP by the Holdback Value Holdback is applied when PV>SP by the Holdback Value Holdback is applied when PV<>SP by the Holdback Value		L3

List Header – Program Edit		Sub-header: 1 to 50. These may also have user defined program names			
Name Ⓢ to select	Parameter Description	Value Press Ⓡ or Ⓢ to change values		Default	Access Level
PV Event	Only appears if 'PVEvent?' in the Program Setup table = 'Yes'. See also section 22.4.1	None	No PV event	None	L3
		Abs Hi	Absolute high		
		Abs Lo	Absolute low		
		Dev Hi	Deviation high		
		Dev Lo	Deviation low		
		Dev Band	Deviation band		
PV Threshold	Only appears when a PV Event is configured. sets the level at which the PV event becomes active	Range units		0	L3
Time Event	To set the type of time event applicable in the selected segment for program channel 2. Only appears if 'TimeEvent?' in the Program Setup table = 'Yes' See also section 22.4.2	Off			L3
		Event1			
On Time	Time wrt the start of the segment at which the event is true. Only appears if 'Time Event' ≠ Off	0:00:00 to 500.00		0:00:00	L3
Off Time	Time wrt the start of the segment at which the event is false. Only appears if 'Time Event' ≠ Off	0:00:00 to 500.00		0:00:00	L3
UsrVal	General purpose user value, only available when PV Event is not configured. this parameter may be given a customised name, see section 27.12.14 ☺ a Reset User Value may be set in the Programmer Status page in operator level.	Range limits. Resolution for 'UsrVal' is derived from 'RstUVal'. To adjust resolution, software a 'user value' to 'RstUVal' and configure its resolution as required.			L3
PID Set	To select the PID set for the selected segment	Set1	PID set 1, 2 or 3 will be used in the selected segment	Set1	L3
		Set2			
		Set3			
GSoak Type	The parameter is only shown if the 'Segment Type' = 'Dwell' and 'Gsoak?' is enabled in Program Setup. Guaranteed Soak ensures that the work piece remains at the specified dwell setpoint for a minimum of the specified duration. Guaranteed Soak continuously monitors the difference between the PV and the programmer setpoint. 'GSoak Type' specifies whether the guaranteed soak tests for deviations above or below the setpoint. See also section 22.5.1	Off	No guaranteed soak applied	Off	L3
		Low	Program is held if $PV < SP + G.Soak Value$		
		High	Program is held if $PV > SP + G.Soak Value$		
		Band	Program is held if $PV <> SP + G.Soak Value$		
G. Soak Value	Value used in evaluation of Guaranteed Soak in Dwell segments.	Range units			L3
If 'Segment Type' = 'GoBack' the following two parameters are shown					
GoBack Seg	This is shown if 'Segment Type' = 'GoBack'. It defines the segment to.	1 to the number of segments defined			L3
GoBack Cycles	To set the number of times the section of the program is repeated. See section 22.3.5.	1 to 999		1	L3
If 'Segment Type' = 'Wait' the following parameter is shown.					

List Header – Program Edit		Sub-header: 1 to 50. These may also have user defined program names			
Name ⌚ to select	Parameter Description	Value Press ⏴ or ⏵ to change values		Default	Access Level
Wait For	Wait For allows you to select the event to become true before proceeding	PrgIn1	Wait for the program event 1		L3
		PrgIn2	Wait for the program event 2		
		PrgIn1n2	Wait for the program event 1 AND 2		
		PrgIn1or2	Wait for the program event 1 OR 2		
		PVWaitIP	Wait segment concludes when 'PVWaitIP' satisfies criterion specified by 'ChX PV Wait' - this option is used to Wait Until a specified value has been reached by 'PVWaitIP'		
If 'Wait For' = 'PVWaitIP' the following two parameters are shown					
PV Wait	Configures the type of alarm to be applied to the 'PVWaitIP' parameter	None	No alarm type applied	None	L3
		Abs Hi	Absolute high		
		Abs Lo	Absolute low		
		Dev Hi	Deviation high		
		Dev Lo	Deviation low		
		Dev Band	Deviation band		
WaitVal	This sets the value at which the 'PV Wait' parameter becomes active. It is not shown if 'PV Wait' = 'None'	Range units		0	L3
If 'Segment Type' = 'Call' the following two parameters are shown					
Call Program	Enter the program number to be inserted in place of the selected segment. Only shown if 'Segment Type' = 'Call'.	UP to 50 (current program number excluded)			L3
Call Cycles	Defines the number of times the inserted program repeats. Only shown if 'Segment Type' = 'Call'.	Cont 1 to 999	Repeats continuously Program executes 1 to 999 times		
End Type	Only shown if 'Segment Type' = 'End'. Defines the action to be taken at the end of the program	Dwell	The program will remain at last SP indefinitely	Dwell	L3
		SafeOP	The power output will go to a defined level		
		Reset	The program will return to controller only mode		
Event Outs	To define the state of up to eight event outputs in the selected segment □□□□□□□□ to ■■■■■■■■ or T□□□□□□□ to ■■■■■■■■ T = Time event: □ = event off; ■ = event on	□ ■ T	Off On Time event. This will be shown in the first event only when 'Time Event = Event 1'. See section 22.4.2	□	L3





## 22.17.5 Examples Showing How to Set up and Run Dual Programmers

The following sections show some examples of setting up program parameters.

### 22.17.5.1 Example 1: Configure a Rate followed by a Dwell Segment

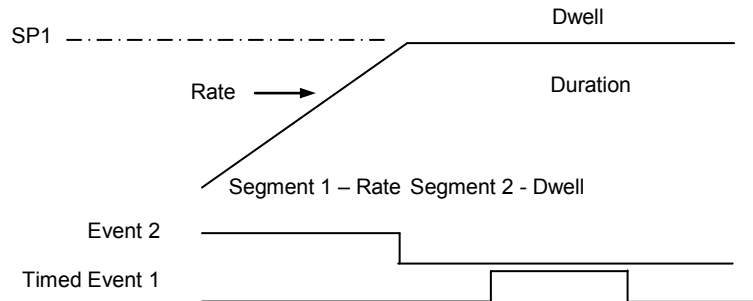
This example applies to Single Channel and SyncStart programmers only. For a SyncAll programmer the procedure is similar except the segments are set up as Time type segments only.







1. In 'Program Setup' select the channel to be set up using  $\blacktriangle$  or  $\blacktriangledown$ . For convenience it is also possible to toggle between Ch1 and Ch2 using the  button. To set Event 1 to be a timed event press  $\odot$  to select 'TimeEvent?' and  $\blacktriangle$  or  $\blacktriangledown$  to 'Yes'. TimeEvent is only available in the Ch1 list and applies to both channels.
2. In 'Program Edit' select the program number to be set up. Using  $\odot$ , scroll through the parameters setting their values as required using  $\blacktriangle$  or  $\blacktriangledown$  at each parameter
3. At 'Segment Type', press  $\blacktriangle$  to 'Rate'
4. At 'Target SP', press  $\blacktriangle$  to the required target SP
5. At 'Ramp Rate', press  $\blacktriangle$  to the required rate of change of SP
6. Scroll through the remaining parameters and set these as required. At 'Event Outs' set Event 2 to  $\blacksquare$
7. The list then returns to Segment (number 2)
8. At 'Segment Type', press  $\blacktriangle$  to 'Dwell'
9. At 'Duration', set this to the time required for the Dwell. It is also possible to set up a guaranteed soak for this segment so that it does not proceed until the segment has been at SP for the required time
10. At 'Time Event', set this to 'Event 1'.  
 $\odot$  'Time Event' will only be displayed if 'TimeEvent?' has been turned on in configuration level in the 'Program Setup' page. Then set the time delay into the segment at which the event is to turn on, followed by the time when it is to turn off.



**Note:** On and Off times are both referenced to the start of the segment – please refer to section 22.4.2 for further details

### 22.17.5.2 Example 2: Configure Segment 3 to Wait For Digital Input LA.

Refer to Chapter 5 for step by step instructions to wire a parameter through the user interface.





1. In configuration level, select 'Program Setup' page and the parameter 'PrgIn1'
2. Press A/MAN, the display will show 'Wire From'
3. Press  until LgclO LA is shown followed by  to select PV
4. Press A/MAN again and  to OK
5. In the 'Program Setup' page the parameter 'PrgIn1' will have the symbol  displayed to the left of the parameter name to indicate that it has been wired to a parameter.
6. In 'Program Edit' page select 'Wait' as the 'Segment Type' in the relevant segment
7. Then select 'Wait For' = 'PrgIn1'
8. When the program is run the program will not progress to the next segment until digital input LA becomes true.

Other strategies may be set up using a similar procedure.

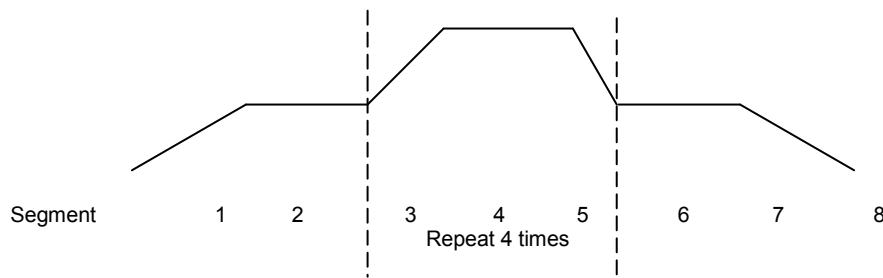
### 22.17.5.3 Example 3: To Repeat a Section of a Program

This uses a GoBack segment



1. Segments 1 to 5 of the program are set up as described in Example 1
2. At Segment 6 adjust 'Segment Type' = 'GoBack'
3. At 'GoBack Seg' set the value to 3 using  or 
4. At 'GoBack Cycles' set the value to 4 using  or 
5. At Segment 7 continue to set the program as described in Example 1

#### 22.17.5.4 Example 4: To Run a Dual Programmer

Programs can be run in operator level 1, 2 or 3

1. Choose the Summary screen which is most appropriate, see section 2.8.1.
2. Press RUN/HOLD button. Run may also be activated from an external source if a digital input has been configured, or via digital communications
3. If a delayed start has been configured the display will ask for a time delay to be entered, then press RUN/HOLD again as prompted. The program will run at the end of the delay time
4. If no program has been set up or other error detected (see section 22.16, Prog error) an error message is displayed, otherwise the program will start to run
5. Briefly press RUN/HOLD button to hold the program or hold this button down for 3 seconds to reset the program
6. The beacons on the top banner show the status of the program e.g. RUN, HLD.

Assuming the Program Status screen has been selected as the summary screen the progress of the program can be read from a list of parameters in this view. These are typically:-

1. Program number or name if a program name has been configured
2. Current segment Number and Type
3. Segment time left
4. Delayed start. Counts down to 0 before starting the program execution. The delay may be cancelled by setting it to 0 while counting down. ☺ when the delay is 1 minute and as the resolution is 1 minute, the delay is decremented and appears to have a value of 0 for 1 minute.
5. Current Status (Run, Hold or Reset)
6. PSP – the current value of the setpoint
7. Segment Target – the value of the SP required at the end of the segment
8. Segment Rate
9. Cycles left
10. Fast run
11. Status of event outputs
12. Program time left
13. Segment time left
14. The above parameters are also available for Ch2. It is possible to toggle between channel 1 and channel 2 using 

#### 22.18 Alternative Ways to Edit a Program

- iTools may be used to enter or edit programs. See Chapter 27 for a description.
- A program may also be set up using SCADA communications. See Appendix A.

☺ If iTools Program Editor is connected then any editable program related parameter cannot be changed for a period of time (approximately 1 minute). After this period these parameters are released and they then become alterable.





## 22.19 Appendix to Chapter 22: Single Programmer Earlier Versions



Software versions 1.XX contained a single control loop and a single programmer block. For reference, this section lists the parameters which were available in these versions

### 22.19.1 Creating or Editing a Single Program

Press  as many times as necessary to select the 'Program' page, or, in configuration level, press the PROG button and this will select the first sub-header - 'All'. This allows you to configure and view parameters common to all programs in the controller.

The following is a list of the parameters.



List Header – Program		Sub-header: All (only available in configuration level)			
Name  to select	Parameter Description	Value Press  or  to change values		Default	Access Level
PV Input	The programmer uses the PV input for a number of functions In holdback, the PV is monitored against the setpoint, and if a deviation occurs the program is paused. The programmer can be configured to start its profile from the current PV value (servo to PV). The programmer monitors the PV value for Sensor Break. The programmer holds in sensor break.	The PV Input is normally wired from the loop TrackPV parameter.  This input is automatically wired when the programmer and loop are enabled and there are no existing wires to track interface parameters. Track interface parameters are Programmer.Setup, PVInput, SPInput, Loop.SP, AltSP, Loop.SP, AltSPSelect.			Conf
SP Input	The programmer needs to know the working setpoint of the loop it is trying to control. The SP input is used in servo to setpoint start.	SP Input is normally wired from the loop Track SP parameter as the PV input.			Conf
Servo	The transfer of program setpoint to PV Input (normally the Loop PV) or the SP Input (normally the Loop setpoint).	PV SP	See also section 22.10.		Conf
Power Fail	Power fail recovery strategy	Ramp Reset Cont	See section 22.11.		Conf
Sync Input	The synchronise input is a way of synchronising programs. At the end of a segment the programmer will inspect the sync. input, if it is True (1) then the programmer will advance to the next segment. It is typically wired from the end of segment output of another programmer. Only appears if 'SyncMode' = 'Yes'	0 1	This will normally be wired to the 'End of Seg' parameter as shown in section 27.10		Conf
Max Events	Sets the maximum number of output events required for the program. This is for convenience to avoid having to scroll through unwanted events in every segment	1 to 8			Conf
SyncMode	Allows multiple controllers to be synchronised at the end of each segment	No Yes	Sync output disabled Sync output enabled		Conf
Prog Reset	Flag showing reset state	No/Yes	Can be wired to logic inputs to provide remote program control		R/O
Prog Run	Flag showing run state	No/Yes			R/O
Prog Hold	Flag showing hold state	No/Yes			R/O
Event 1 to 8	Flags showing event states	No/Yes			R/O
End of Seg	Flag showing end of segment state	No/Yes			R/O

Now select the program number to be created or edited. (Press  followed by  or .

Programs can be created and edited in Level 3 or configuration level.

This gives access to parameters which allow you to set up each segment of the selected program.

The following table lists these parameters:-

List Header – Program		Sub-header: 1 to 50			
Name  to select	Parameter Description	Value Press  or  to change values		Default	Access Level
Segments Used	This value automatically increments when another segment is added	1 to 50		1	R/O
Holdback Value	Deviation between SP and PV at which holdback is applied. This value applies to the whole program.	Minimum setting 0			L3
Ramp Units	Time units applied to the segments	Sec Min Hour	Seconds Minutes Hours		L3
Cycles	Number of times the whole program repeats	Cont 1 to 9999	Repeats continuously Program executes once to 9999 times		L3
Segment	To select the segment to set up	1 to 50			L3
Segment Type	To define the type of segment. See also section 22.3	End Rate Time Dwell Step Call	Last segment in the program Rate of change of SP Duration to new SP Duration at previous SP Rapid change to new SP To insert a new program in the current program	End	L3
End Type	Only shown if 'Segment Type' = 'End'. Defines the action to be taken at the end of the program	Dwell Reset	The program will remain at last SP indefinitely The program will return to controller only mode	Dwell	L3
Call Program	Only shown if 'Segment Type' = 'Call'. Enter the program number to be inserted in place of the selected segment	Up to 50 (current program number excluded)			L3
Call Cycles	Only shown if 'Segment Type' = 'Call'. Defines the number of times the inserted program repeats	Cont 1 to 999	Repeats continuously Program executes once to 999 times		L3
Holdback Type	Sets the type of holdback applicable to the selected segment	Off Low High Band	No holdback applied Deviation low Deviation high Deviation high and low		L3
Duration	Only shown if 'Segment Type' = 'Dwell' or 'Time'. Sets the time to execute the segment.	0:00.0 to 500:00 0.1 sec to 500 hours			L3
Target SP	Only shown if 'Segment Type' = 'Rate', 'Time' or 'Step'. To enter the SP which is to be achieved at the end of the segment				L3
Ramp Rate	Only shown if 'Segment Type' = 'Rate'. To enter the rate in units/time at which the SP is required to change	0.1 to 9999.9 units per sec, min or hour			L3
Event Outs	To define the state of up to eight event outputs in the selected segment □□□□□□□□ to ■■■■■■■■	□ = Off ■ = On			L3

### 22.19.2 Sync mode

This mode will allow two or more single loop controller/programmers to be synchronised together. This means that the start of each segment (excluding the first) will begin at the same time. Two or more instruments may be synchronised by wiring the “end of segment” and “sync input” parameters between units. (see diagram below).

Set “SyncMode” to Yes.



**Note:** ‘SyncMode is no longer available in the dual programmer

Wire instruments as follows :-

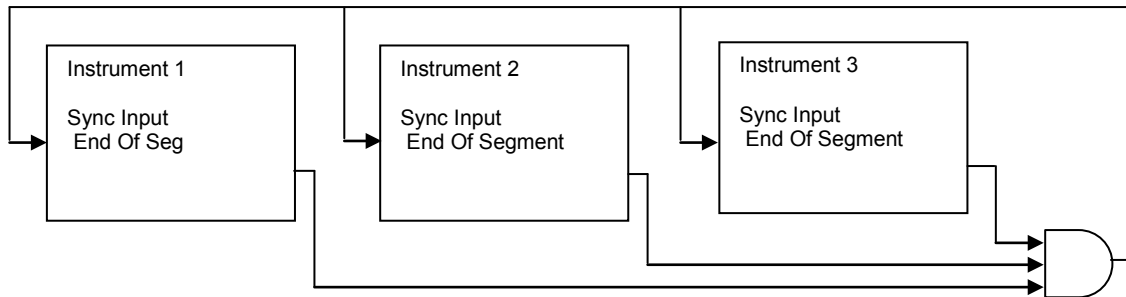

At the end of a segment, the program will be put into a temporary hold state (program status will continue to show that the program is running), the hold beacon will flash, the end\_of\_segment parameter will be true. Once all segments have completed, the SyncInput goes high and the next segment is started.

If the “SyncMode” is disabled, the “End\_Of\_Segment” parameter is guaranteed to be true for 1 tick at the end of every segment.

## 23. Chapter 23 Switch Over

This facility is commonly used in temperature applications which operate of a wide range of temperature. A thermocouple may be used to control at lower temperatures and a pyrometer then controls at very high temperatures. Alternatively two thermocouples of different types may be used.

The diagram below shows a process heating over time with boundaries which define the switching points between the two devices. The higher boundary (2 to 3) is normally set towards the top end of the thermocouple range and this is determined by the 'Switch Hi' parameter. The lower boundary (1 to 2) is set towards the lower end of the pyrometer (or second thermocouple) range using the parameter 'Switch Lo'. The controller calculates a smooth transition between the two devices.

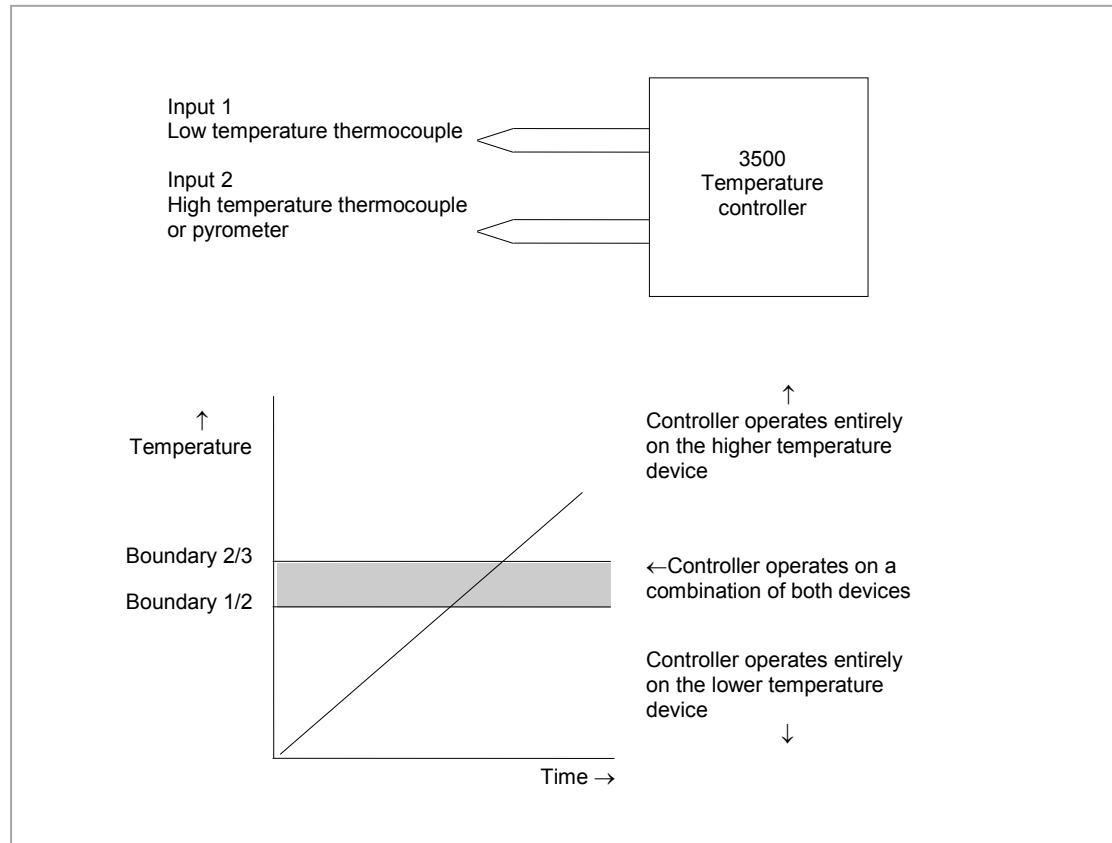









Figure 23-1: Thermocouple to Pyrometer Switching

### 23.1.1 Example: To Set the Switch Over Levels

Select Level 3 or configuration level

1. Press  as many times as necessary to display the 'SwOver' header
2. Press  to scroll to 'Switch Hi'
3. Press  or  to a value which is suitable for the pyrometer (or high temperature thermocouple) to take over the control of the process
4. Press  to scroll to 'Switch Lo'
5. Press  or  to a value which is suitable for the low temperature thermocouple to control the process

## 23.1.2 Switch Over Parameters

List Header – SwOver		Sub-headers: None			
Name Ⓢ to select	Parameter Description	Value Press ▼ or ▲ to change values		Default	Access Level
Input Hi	Sets the high limit for the switch over block. It is the highest reading from input 2 since it is the high range input sensor.	Input range			L3
Input Lo	Sets the low limit for the switch over block. It is the lowest reading from input 1 since it is the low range input sensor				L3
Switch Hi	Defines the high boundary of the switchover region	Between Input Hi and Input Lo			L3
Switch Lo	Defines the low boundary of the switchover region.				L3
Input 1	The first input value. This must be the low range sensor.	These will normally be wired to the thermocouple/pyrometer input sources via the PV Input or Analogue Input Module. The range will be the range of the input chosen.			R/O if wired
Input 2	The second input value. This must be the high range sensor				R/O if wired
Fall Value	In the event of a bad status, the output may be configured to adopt the fallback value. This allows the strategy to dictate a safe output in the event of a fault being detected	Between Input Hi and Input Lo		0.0	L3
Fall Type	Fall back type	Clip Bad Clip Good Fall Bad Fall Good Upscale Downscale	See section 18.4.2	Clip Bad	Conf
Selected IP	Indicates which input is currently selected	Input 1 Input 2	0: Input 1 has been selected 1: Input 2 has been selected 2: Both inputs are used to calculate the output		R/O
ErrMode	The action taken if the selected input is BAD	UseGood	0: Assumes the value of a good input If the currently selected input is BAD the output will assume the value of the other input if it is GOOD	UseGood	Conf
		ShowBad	1: If selected input is BAD the output is BAD		
Switch PV	The process variable produced from the 2 input measurements				R/O
Status	Status of the switchover block	Good Bad			R/O



## 24. Chapter 24 Transducer Scaling

The 3500 controller includes two transducer calibration function blocks which may be enabled in configuration level in the 'Inst' 'Opt' page. These are software function blocks which provide a method of offsetting the calibration of the controller input when compared to a known input source.

This chapter describes the full procedures for setting up fixed parameters and for performing transducer calibration in Level 3 and Configuration access levels.

Transducer scaling is often performed, however, as a routine operation on a machine to take out system errors. For this reason a limited set of calibration parameters can be made available in operator levels 1 and 2 by configuring the parameter 'Cal Enable' (section 24.6) to 'Yes'. The relevant calibration parameters are found in the Transducer Summary pages, Txdr1 or Txdr2, (section 2.8.1.7).

Transducer scaling can be applied to any input or derived input, i.e. the PV Input or Analogue Input fitted in one of the module slots. These can be wired in configuration level to the above inputs.

Four types of calibration are explained in this chapter in Level 3 or configuration levels:-

- Auto-tare
- Shunt Calibration
- Load Cell Calibration
- Comparison Calibration

### 24.1 Auto-Tare Calibration

The auto-tare function is used, for example, when it is required to weigh the contents of a container but not the container itself.

The procedure is to place the empty container on the weigh bridge and 'zero' the controller. Since it is likely that following containers may have different tare weights the auto-tare feature can be made available in all operator access levels by configuring the parameter 'Cal Enable' to 'Yes'. The procedure to enter a tare offset is described in section 24.2.1. and is the same in all access levels.

Tare calibration may be carried out no matter what type of transducer is in use.

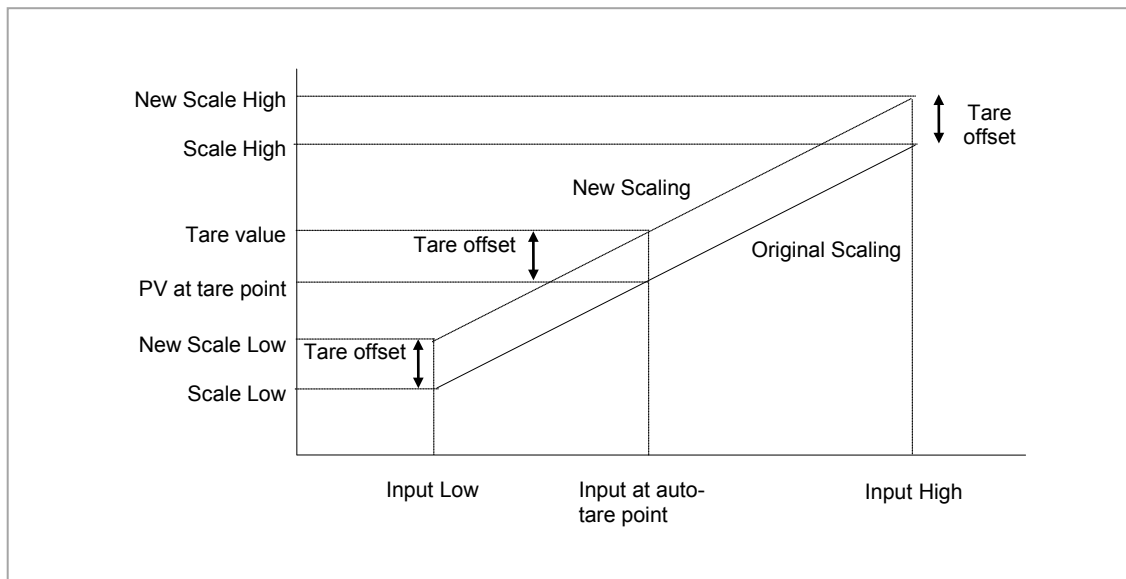

Figure 24-1: Effect of Auto Tare

## 24.2 Transducer Summary Page







If the Transducer function block has been enabled then a transducer summary page is available in operator level 1 and 2. This means that calibration of the transducers can be done at this level although with some small limitations.

### 24.2.1 Tare Calibration

The 3500 controller has an auto-tare function which is used, for example, when it is required to weigh the contents of a container but not the container itself.

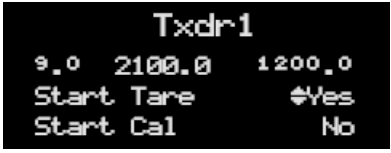
The procedure is to place the empty container on the weighbridge and 'zero' the controller. Since it is likely that following containers may have different tare weights the auto-tare feature is available in the controller at access level 1 (provided 'Cal Enable' is set to 'Yes' in configuration level).

The procedure is as follows:-

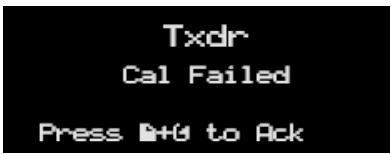
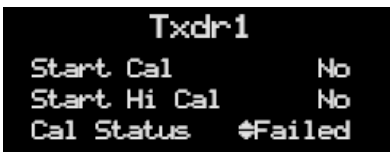
Do This	The Display You Should See	Additional Notes
1. Place the empty container on the weigh bridge		
2. Press  until the Txdr1 (or 2) page is displayed 3. Press  until 'Start Tare' is displayed		
4. Press  or  to select 'Yes'		<p>The controller automatically calibrates the tare weight which is measured by the transducer and stores this value.</p> <p>During this measurement the displays shown here will be shown</p>
		
		<p>If the calibration fails the message Cal Failed will be shown.</p> <p>This may be due to the measured input being out of range</p>
		<p>This will also be shown in the parameter list</p>

### 24.3 Strain Gauge

A strain gauge consists of a resistive four wire measurement bridge where all four arms are in balance when no pressure is being measured. It is energised by the transducer power supply, normally 5Vdc or 10Vdc, which is a module fitted into any slot. It is calibrated by switching a calibration resistor across one arm of the four wire measurement bridge. For this reason the calibration is referred to as 'Shunt' calibration. The value of this resistor is chosen so that it represents 80% of the span of the transducer.

Some transducers have the calibration resistor fitted internally in the transducer itself. In this case the parameter 'Shunt' in the transducer power supply module is set to 'External'. If the transducer does not have a calibration resistor fitted, set 'Shunt' = 'Internal'. In this case the controller uses its calibration resistor which is mounted in the power supply module. The value of this resistor is 30.1KΩ. Consult the data provided by the transducer manufacturer to determine if this resistor is correct for the transducer in use. If not it will be necessary to fit resistors externally to achieve the correct value.

#### 24.3.1 Calibration Using the Calibration Resistor Mounted in the Transducer.

This is illustrated using the following example:-

Strain Gauge range 0 to 3000 psi, output 3.33mV/V (this figure is quoted by the manufacturer)

Transducer power supply set to 10 Volt excitation (fitted in module position 4). This produces a full load output of 33.3mV

##### 24.3.1.1 Physical Wiring

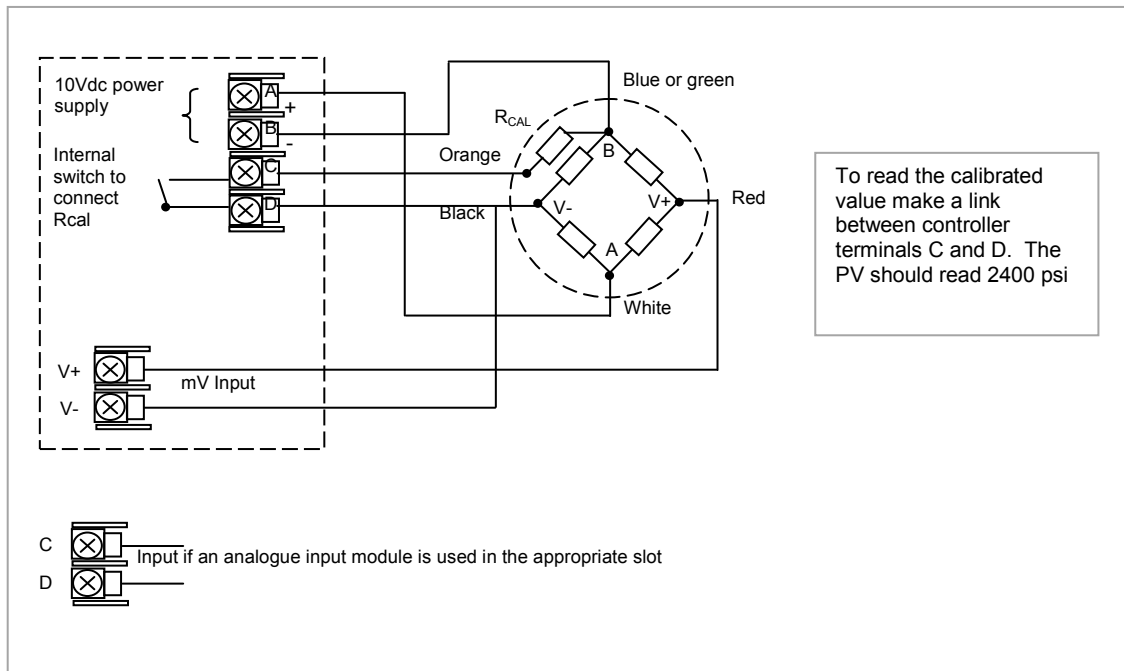

Figure 24-2: Pressure Transducer Wiring Diagram

The above example uses the Dynisco model PT420A.

Set the transducer power supply module parameter 'Shunt' to 'External'.

**24.3.2 Configure Parameters for Strain Gauge Calibration**

Configure the controller as follows:-





Step	Description		
1	Enable one Txdr block in the controller options page (see example section 24.3.3.1)		
2	PV Input values (see example section 24.3.3.2)	IO Type	40mV
		Lin Type	Linear
		Units	PSI or as required
		Res'n	XXXX.X
		Disp Hi	3000
		Disp Lo	0
		Range Hi	33.30
		Range Lo	0
		Fallback	Upscale
3	Transducer Power Supply module (see example section 24.3.3.3)	Voltage	10 Volts
		Shunt	Internal if the calibration resistor is fitted in the controller External if the calibration resistor is fitted in the transducer
4	Txdr Values (see example section 24.3.3.4)	Cal Type	Shunt
		Cal Enable	Yes
		Range Max	3000
		Clear Cal	No. If set to yes this will clear the previous calibration. It may be necessary to reset some of the values in this table. For example, Input Hi and Scale Hi.
		Input Hi	3000
		Scale Hi	2400 (80% of 3000)
5	Internal (Soft) wiring (see example section 24.3.3.5)	Txdr Input Value from PVInput PV	If an analogue input module is used wire the Txdr Input to the PV of the module
		TransPSU PV from Txdr ShuntState	The operation for Shunt calibration is made fully automatic when this wire is made

### 24.3.3 Configuration Examples

The following sections show examples of how these parameters are configured. Skip this section if this explanation is not required or if the calibration is being carried out in access levels 1 or 2.

#### 24.3.3.1 Enable a Transducer Function Block



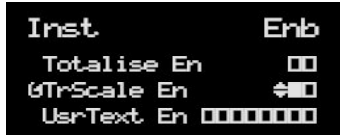
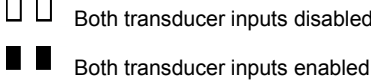

In configuration level:-

Do This	The Display You Should See	Additional Notes
<ol style="list-style-type: none"> <li>Press  as many times as necessary to select the 'Inst <math>\nabla</math> Enb' page.</li> <li>Press  to scroll to 'TrScale En' and  or  to enable</li> </ol>		

#### 24.3.3.2 Configure the Input





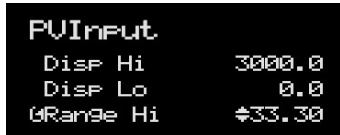

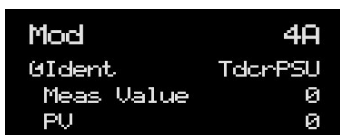

Set input to 33.3mV where 0mV = reading of 0.0 and 33.3 mV = reading of 3000.0

In configuration level:-

Do This	The Display You Should See	Additional Notes
<ol style="list-style-type: none"> <li>Press  as many times as necessary to select the input to be calibrated</li> </ol>		Configure 'IO Type' to 40mV, 'Lin Type' to Linear and 'Units' as required
<ol style="list-style-type: none"> <li>Use  to scroll to the required parameter</li> <li>Use  or  to change parameter values</li> </ol>		Configure 'Disp Hi' and 'Disp Lo' to correspond to strain gauge range, 0 to 3000 Configure 'Range Hi' and 'Range Lo' to the input mV range 0 – 33.30mV



#### 24.3.3.3 Configure the Transducer Power Supply Module

In configuration level:-

Do This	The Display You Should See	Additional Notes
<ol style="list-style-type: none"> <li>Press  as many times as necessary to select the module in which the Transducer Power Supply is fitted</li> </ol>		In this example Mod 4. As a single output module only 4A is available
<ol style="list-style-type: none"> <li>Press  to scroll to 'Shunt' and  or  to change to 'External'</li> <li>Press  to scroll to 'Voltage' and  or  to change to '10 Volts'</li> </ol>		External refers to the calibration resistor $R_{CAL}$ fitted externally to the controller (internally in the transducer). An excitation of 10V will give an input of 3.33mV/V i.e. 33.3mV

### 24.3.3.4 Transducer Values

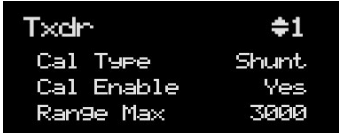











In configuration level:-

Do This	The Display You Should See	Additional Notes
1. Press  as many times as necessary to select the Transducer to be calibrated		In this example transducer 1 is being used. Configure 'Cal Type' = 'Shunt' 'Cal Enable' = 'Yes' (this enables cal parameters, and calibration may be done in operator levels). Set 'Range Max' and 'Range Min' to the range of the transducer – 0 to 3000 psi
2. Press  to select 'Scale Hi'		'Scale Hi' should be set to 80% of the maximum range of the transducer. In this case 2400.0 The controller takes a number of measurements to determine when the calibration should take place. Cal Band sets the allowed difference between two consecutive averages. If set to 0.5 the averages must be within +/-0.5 before calibration takes place. A lower setting requires the controller to settle for a longer period. Calibration accuracy is not necessarily affected other than setting at extremes.

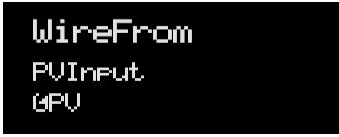
### 24.3.3.5 Internal (Soft) Wiring

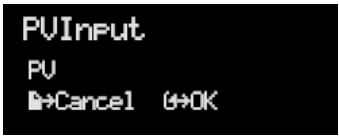
Assuming the PV input on terminals V+ and V- are used, internally wire transducer 'Input Value' from 'PVInput PV'.

In configuration level:-

Do This	The Display You Should See	Additional Notes
1. From any display press  to select 'Txdr' page	 ↑ Indicates parameter selected	This locates the parameter you want to wire TO
2. Press  to scroll to the parameter to 'Input Value'		
3. Press  to display 'WireFrom'		In configuration mode the A/MAN button is the Wire button.
4. Press  to navigate to the 'PVInput' list header		
5. Press  to scroll to 'PV'		
6. Press 		This 'copies' the parameter to be wired FROM
7. Press  as instructed to confirm	 ↑ Indicates that the parameter is wired.	This 'pastes' the parameter If you want to inspect this press  . Press  again to go back to the display above.

Repeat the above steps to wire 'TransducerPSU PV' from Transducer 'ShuntState'

Internal wiring through the controller front panel is also explained in section 5.1. Internal wiring may also be created using iTools see section 27.10.

### 24.3.4 Strain Gauge Calibration

The display views shown below are taken from the configuration level. The calibration can be carried out in operator levels unless it has been blocked.

Remove all pressure from the transducer

Then:-

Do This	The Display You Should See	Additional Notes
1. Press  to select 'Start Cal' and  or  to Yes	<pre>Txdr-      1 Start Cal  #No Clear Cal  No Tare Value 0</pre>	A pop up message will appear for 1.5 seconds showing that calibration has commenced
	<pre>Txdr- Cal Passed</pre>	<p>If successful another pop up will be displayed for 1.5 seconds.</p> <p>If the calibration failed an acknowledge pop up will appear. This might happen, for example, if 'Lo Cal' is done with the full load applied.</p>

### 24.3.5 Calibration Using the Internal Calibration Resistor

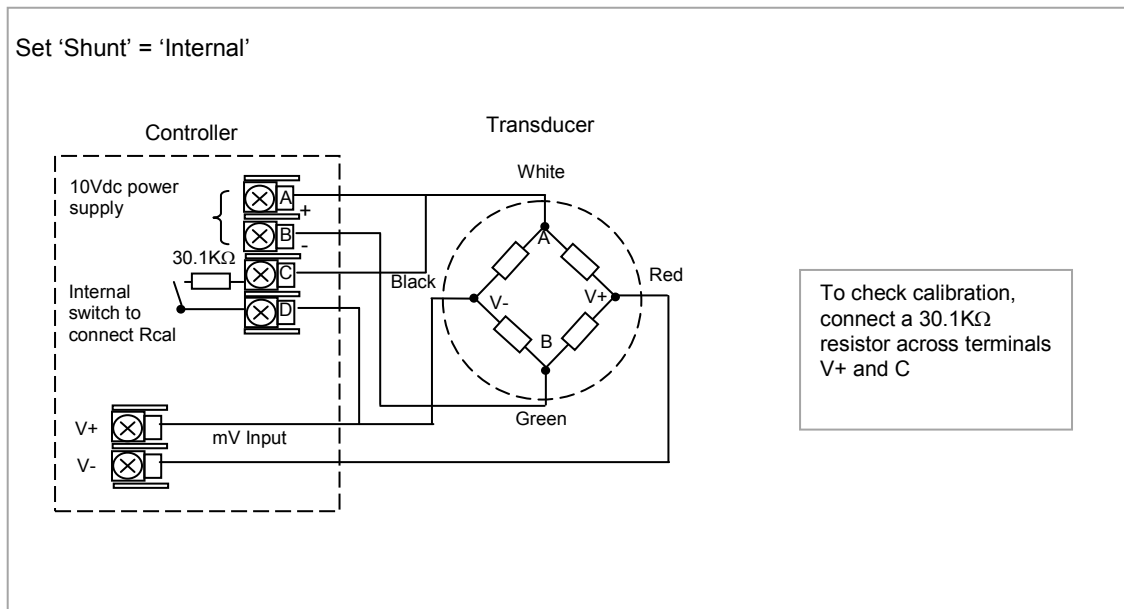

Figure 24-3: Strain Gauge Wiring Diagram - Internal Calibration Resistor

Connect the transducer as shown above.

Configuration of input and soft wiring is the same as described in the Configuration Examples section 24.3.3.

```
Mod      4A
Status   OK
Shunt    #Internal
Voltage  10 Volts
```

Set the transducer power supply 'Shunt' parameter to 'Internal'

The calibration procedure is the same as described in the previous section.

### 24.4 Load Cell

A load cell provides an analogue output which can be in Volts, milli-Volts or milli-Amps. This may be connected to the PV Input or Analogue Input.

The method of calibration is performed on load cells using the transducer power supply module. The unloaded cell is first measured to establish a zero reference.

A known reference weight is then placed on the load cell and a high end calibration is performed.

In practice there may be a residual output from the load cell and this can be offset in the controller.

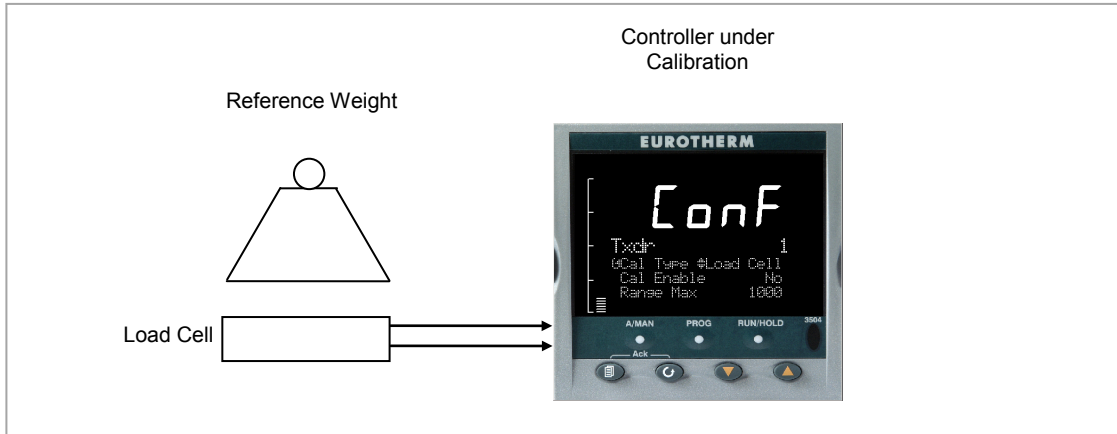

Figure 24-4: Load Cell

#### 24.4.1 To Calibrate a Load Cell

This is illustrated using the following example:-

Load cell Range 0 to 2000 grams, load cell output 2mV/V (quoted by the manufacturer)

Transducer power supply set to 10 Volt excitation (fitted in module position 4). This produces a full load output of 20.0mV

##### 24.4.1.1 Physical Wiring

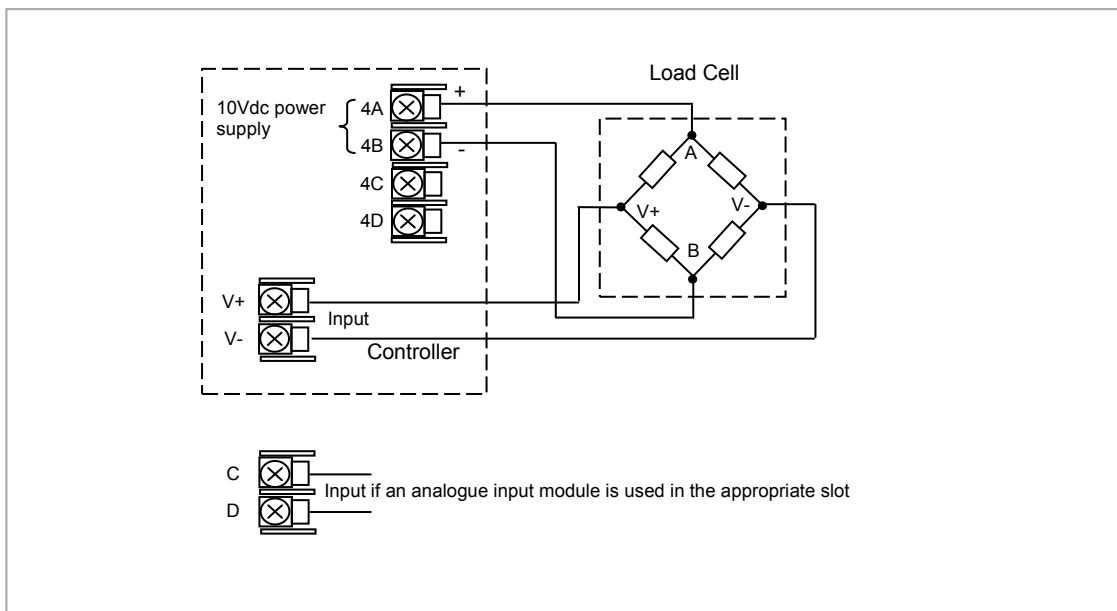

Figure 24-5: Load Cell Wiring Diagram



**24.4.2 Configure Parameters**

Configure the controller as follows:-

Step	Description		
1	Enable one Txdr block in the controller options page (see example section 24.3.3.1)		
2	PV Input values (see example section 7.2.6)	IO Type	40mV
		Lin Type	Linear
		Units	None or as required
		Res'n	XXXX.X
		Disp Hi	2000
		Disp Lo	0
		Range Hi	20.00
		Range Lo	0
		Fallback	Upscale
3	Transducer Power Supply module (see example section 10.3.11)	Voltage	10 Volts
		Shunt	Not applicable
4	Txdr Values (see also section 24.6)	Cal Type	Load Cell
		Cal Enable	Yes
		Range Max	2000
		Clear Cal	No. If set to yes this will clear the previous calibration.
		Input Hi	2000
		Scale Hi	Not applicable
5	Internal (Soft) wiring (see example section 5.1)	Txdr Input Value from PVInput PV	If an analogue input module is used wire the Txdr Input to the PV of the module





### 24.4.3 Configuration Examples

The following sections show examples of how these parameters are configured. Skip this section if this explanation is not required or if the calibration is being carried out in access levels 1 or 2.

#### 24.4.3.1 Configure the Input

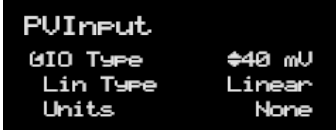

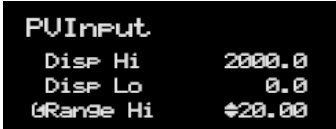

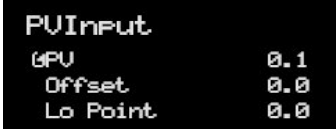
Set input to 20mV where 0mV = reading of 0 and 20.0 mV = reading of 2000

In configuration level:-

Do This	The Display You Should See	Additional Notes
1. From any display press  as many times as necessary to select the input to be calibrated		Configure IO Type to 40mV, Lin Type to Linear and Units as required
2. Use  to scroll to the required parameter		Configure 'Disp Hi' and 'Disp Lo' to correspond to load cell range – 0 to 2000 Configure 'Range Hi' and 'Range Lo' to input mV range 0 – 20mV
3. Use  or  to change parameter values		Do not set offsets at this stage.

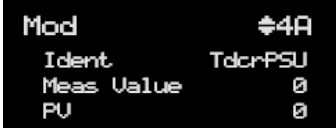

#### 24.4.3.2 Configure the Transducer Power Supply Module

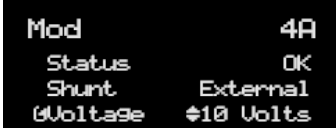
In configuration level:-







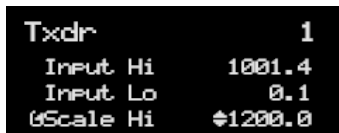
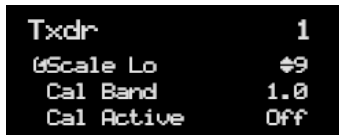

Do This	The Display You Should See	Additional Notes
1. From any display press  as many times as necessary to select the module in which the Transducer Power Supply is fitted		In this example Mod 4. As a single output module only 4A is available
2. Press  to scroll to 'Voltage' and  or  to change to '10 Volts'		An excitation of 10V will give an input of 2mV/V i.e. 20.0mV. 'Shunt' has no effect for a load cell.

### 24.4.3.3 Transducer Values

In configuration level:-

Do This	The Display You Should See	Additional Notes
1. From any display press  as many times as necessary to select the Transducer to be calibrated		In this example transducer 1 is being used. Configure Cal Type = Load Cell Cal Enable = Yes (this enables cal parameters, and calibration may be done in operator levels). Set Range Max and Range Min to the range of the transducer, 0 to 2000 grams
2. Press  to select further parameters		It is not necessary to set 'Input Hi' and 'Input Lo' or 'Scale Hi' and 'Scale Lo'.
		The controller takes a number of measurements to determine when the calibration should take place. Cal Band sets the allowed difference between two consecutive averages. If set to 1.0 the average must be within $\pm 1.0$ before calibration takes place. A lower setting requires the controller to settle for a longer period. Calibration accuracy is not necessarily affected other than extreme settings.

### 24.4.4 Load Cell Calibration

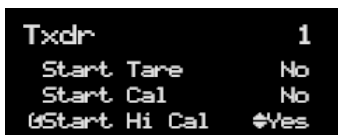
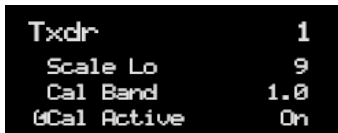
Do This	The Display You Should See	Additional Notes
1. Remove all load from the load cell		
2. Press  to scroll back to 'Start Cal' and  or  to 'Yes'		This starts the low calibration point. A pop up message will appear for 1.5 seconds showing that calibration has commenced
		If successful a pop up will be displayed for 1.5 seconds. If calibration fails an acknowledge pop up will appear. This might happen, for example, if low calibration is done with the full load applied.
3. Add a load to the load cell (this would normally be at full scale of the transducer but may be done with lower weights)		
4. Press  to scroll to 'Start Hi Cal' and  or  to 'Yes'		The controller repeats the same procedure as for the low Calibration point
		During calibration Cal Active = On Input Value is the PV before scaling Output Value is the output from the transducer scaling block.

**24.4.4.1 Offsets**

It is possible that a residual output from the transducer exists which means that there is an error in the span and/or zero reading. The residual output is likely to occur under the no load condition, in which case it can be compensated for by applying a simple offset as follows:-

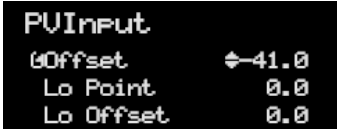
Do This	The Display You Should See	Additional Notes
1. In the PV Input list scroll to Offset and adjust until the no load condition reads 0.0	 <pre> PVInput Offset      ←-41.0 Lo Point    0.0 Lo Offset   0.0                     </pre>	Configure IO Type to 40mV, Lin Type to Linear and Units as required.  Offset is also described in section 0.

If a different error occurs at both high and low points a two point offset can be applied as follows:-

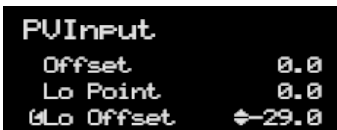
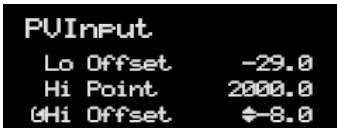
Do This	The Display You Should See	Additional Notes
1. In the PV Input list scroll to Lo Offset and adjust until the no load condition reads 0.0	 <pre> PVInput Offset      0.0 Lo Point    0.0 Lo Offset   ←-29.0                     </pre>	Lo Point should be set to 0 to correspond to the transducer range
2. In the PV Input list scroll to Hi Offset and adjust until the full load condition reads 2000.0	 <pre> PVInput Lo Offset   -29.0 Hi Point    2000.0 Hi Offset   ←-8.0                     </pre>	Hi Point should be set to 2000 to correspond to the transducer range.  High and Low offsets are also described in section 7.2.8.

## 24.5 Comparison

Comparison calibration is used to calibrate the controller against a known reference instrument.

The load is removed (or taken to a minimum) from both instruments. The controller low end calibration is done using the 'Start Calibration' parameter. This enables a 'CalAdjust' parameter which is a scaling factor on the 'Output Value' to read the same as the reference instrument. The Output Value may be wired for use in a control strategy and displayed, for example, on a user screen

To calibrate the high end, add a weight to both transducers and when the reading has become stable select the 'Start Hi Cal' parameter then enter the new reading from the reference instrument into 'CalAdjust'.

The Output Value can be internally wired as the measured value in a particular control strategy.

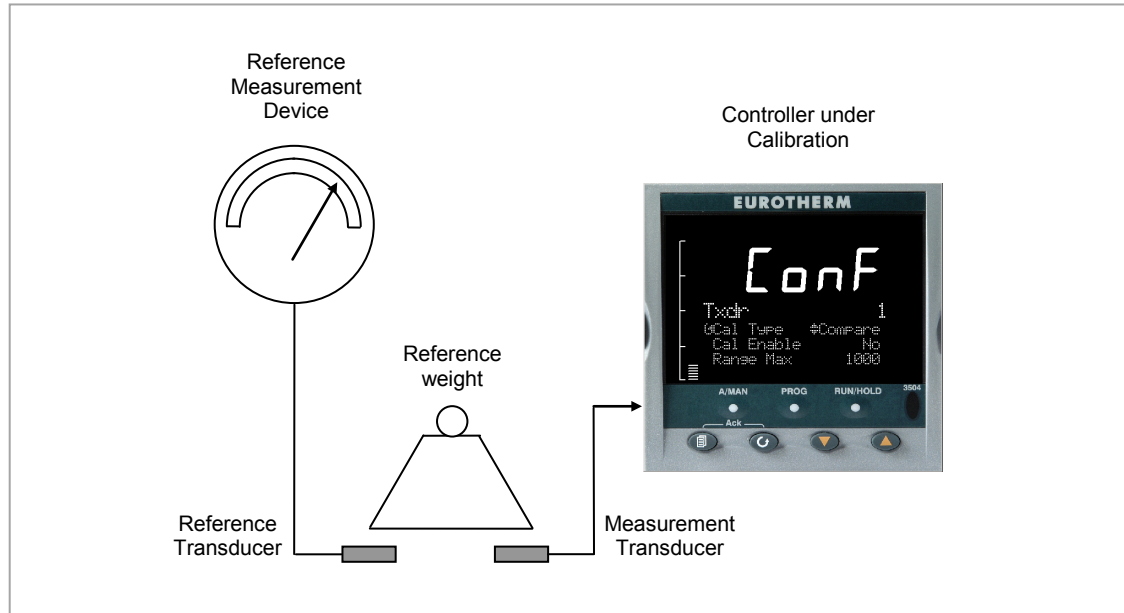

Figure 24-6: Comparison Calibration









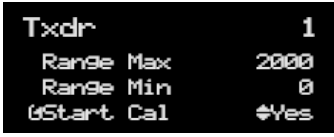

### 24.5.1 Physical Wiring

As Load Cell

### 24.5.2 Configure Parameters

Configure the controller the same as for the load cell except set the Txdr 'Cal Type' to 'Compare'

**24.5.3 Comparison Calibration**

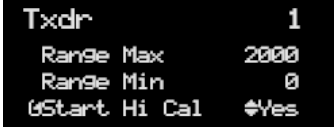
Do This	The Display You Should See	Additional Notes
1. Remove or reduce the load from the load cell to establish a low end reference		
2. Press  to scroll to 'Start Cal' and  or  to 'Yes'		This starts the low calibration point.
3. A 'Cal Adjust' parameter becomes available. Use  or  to enter the difference between the controller measured value and the reference instrument reading.		A value must be entered before the controller will proceed to the next state.
4. Confirm the value		
5. <b>Add a load to the load cell (this would normally be at full scale of the transducer but may be done with lower weights)</b>		
6. Press  to scroll to 'Start Hi Cal' and  or  to 'Yes'		
7. Repeat 3 and 4 above for the high point		The 'Output Value' parameter should now read the same as the reference instrument

## 24.6 Transducer Scaling Parameters

The following parameters allow the transducer type to be configured and calibrated:-

List Header – Txdr		Sub-headers: 1 or 2			
Name ☺ to select	Parameter Description	Value Press ▼ or ▲ to change values		Default	Access Level
Cal Type	Used to select the type of transducer calibration to perform See descriptions at the beginning of this chapter.	0: Off 1: Shunt 2: Load Cell 3: Compare	Transducer type unconfigured Shunt calibration Load Cell Comparison	Off	Conf
Cal Enable	To make the transducer ready for calibration. Must be set to Yes to allow calibration to be done at L1. This includes Tare Cal.	No Yes	Not ready Ready	No	Conf
Range Max	The maximum permissible range of the scaling block	Range minimum to maximum display (99999)		1000	Conf
Range Min	The minimum permissible range of the scaling block	Minimum display (-19999) to Range max		0	Conf
Start Tare	Begin tare calibration	No Yes	Start tare calibration	No	L1 if 'Cal Enable' = 'Yes'
Start Cal	Starts the Calibration process. ☺ for Load Cell and Comparison calibration 'Start Cal' starts the first calibration point.	No Yes	Start calibration	No	L1 if 'Cal Enable' = 'Yes'
Start Hi Cal	For Load Cell and Comparison calibration the 'Start High Cal' must be used to start the second calibration point.	No Yes	Start high calibration	No	L1 if 'Cal Enable' = 'Yes'
Clear Cal	Clears the current calibration constants. This returns the calibration to unity gain	No Yes	To delete previous calibration values	No	L3
Tare Value	Enter the tare value of the container	Range between maximum display and minimum display			Conf
Input Hi	Sets the scaling input high point	Range between Input Lo and maximum display			L3
Input Lo	Sets the scaling input low point	Range between Input Hi and minimum display			L3
Scale Hi	Sets the scaling output high point. Usually the same as the 'Input Hi'	Range between Scale Lo and maximum display			L3
Scale Lo	Sets the scaling output low point. Usually 80% of 'Input Lo'	Range between Scale Hi and minimum display			L3
Cal Band	The calibration algorithms use the threshold to determine if the value has settled. When switching in the shunt resistor, the algorithm waits for the value to settle to within the threshold before starting the high calibration point.	0.0 to 99.999			Conf
Shunt State	Indicates when the internal shunt calibration resistor is switched in. Only appears if 'Cal Type' = 'Shunt'	Off On	Resistor not switched in Resistor switched in		L1
Cal Active	Indicates calibration taking place	Off On	Inactive Active		L1 R/O
Input Value	The input value to be scaled.	Minimum display – Maximum display (-9999.9 to 9999.9)			L3
Output Value	The Input Value is scaled by the block to produce the Output Value	Range between Scale Hi and Scale Lo			L3

List Header – Txdr		Sub-headers: 1 or 2			
Name Ⓞ to select	Parameter Description	Value Press ▼ or ▲ to change values		Default	Access Level
Output Status	The sensor break/fault status of the PV output	Good Bad			Conf
Cal Status	Indicates the progress of calibration	0: Idle 1: Active 2: Passed 3: Failed	No calibration in progress Calibration in progress Calibration Passed Calibration Failed		L1 R/O

#### 24.6.1 Parameter Notes



Enable Cal	<p>This may be wired to a digital input for an external switch. If not wired, then the value may be changed.</p> <p>When enabled the transducer parameters may be altered as described in the previous sections. When the parameter has been turned On it will remain on until turned off manually even if the controller is power cycled.</p>
Start Tare	This may be wired to a digital input for an external switch. If not wired, then the value may be changed.
Start Cal	<p>This may be wired to a digital input for an external switch. If not wired, then the value may be changed.</p> <p>It starts the calibration procedure for:</p> <p>Shunt Calibration The low point for Load Cell Calibration The low point for Comparison Calibration</p>
Start Hi Cal	<p>This may be wired to a digital input for an external switch. If not wired, then the value may be changed.</p> <p>It starts:-</p> <p>The high point for Load Cell Calibration The high point for Comparison Calibration</p>
Clear Cal	<p>This may be wired to a digital input for an external switch. If not wired, then the value may be changed.</p> <p>When enabled the input will reset to default values. A new calibration will overwrite the previous calibration values if Clear Cal is not enabled between calibrations.</p>



## 25. Chapter 25 User Values

User values are registers provided for use in calculations. They may be used as constants in equations or temporary storage in extended calculations. Up to 16 User Values are available provided they have been enabled in the 'Inst' 'Enb' page (Chapter 6) in configuration level. Each User Value can then be set up in the 'UserVal' page.

### 25.1 User Value Parameters

List Header – UsrVal		Sub-headers: 1 to 16		
Name  to select	Parameter Description	Value Press  or  to change values	Default	Access Level
Units	Units assigned to the User Value	None Abs Temp °C/°F/°K, V, mV, A, mA, PH, mmHg, psi, Bar, mBar, %RH, %, mmWG, inWG, inWW, Ohms, PSIG, %O2, PPM, %CO2, %CP, %/sec, RelTemp °C/°F/°K(rel), Vacuum Custom 1, Custom 2, Custom 3, Custom 4, Custom 5, Custom 6, sec, min, hrs,		Conf
Res'n	Resolution of the User Value	XXXXX to X.XXXX		Conf
High Limit	The high limit may be set for each user value to prevent the value being set to an out-of-bounds value.		99999	L3
Low Limit	The low limit of the user value may be set to prevent the user value from being edited to an illegal value. This is important if the user value is to be used as a setpoint.		-99999	L3
Value	To set the value within the range limits	See note 1		L3
Status	Can be used to force a good or bad status onto a user value. This is useful for testing status inheritance and fallback strategies.	Good Bad	<a href="#">See note 1</a>	L3

**Note 1:**

If 'Value' is wired into but 'Status' is not, then, instead of being used to force the Status it will indicate the status of the value as inherited from the wired connection to 'Value'.

## 26. Chapter 26 Calibration

The controller is calibrated during manufacture using traceable standards for every input range. It is, therefore, not necessary to calibrate the controller when changing ranges. Furthermore, the use of a continuous automatic zero correction of the input ensures that the calibration of the instrument is optimised during normal operation.

To comply with statutory procedures such as the Heat Treatment Specification AMS2750, the calibration of the instrument can be verified and re-calibrated if considered necessary in accordance with the instructions given in this chapter.

For example AMS2750 states:- "Instructions for calibration and recalibration of "field test instrumentation" and "control monitoring and recording instrumentation" as defined by the NADCAP Aerospace Material Specification for pyrometry AMS2750D clause 3.2.5 (3.2.5.3 and sub clauses)" Including Instruction for the application and removal of offsets defined in clause 3.2.4

### 26.1 To Check Input Calibration

The PV Input may be configured as mV, mA, thermocouple or platinum resistance thermometer.

#### 26.1.1 Precautions

Before checking or starting any calibration procedure the following precautions should be taken:-

- When calibrating mV inputs make sure that the calibrating source output is set to less than 250mV before connecting it to the mV terminals. If accidentally a large potential is applied (even for less than 1 second), then at least one hour should elapse before commencing the calibration.
- RTD and CJC calibration must not be carried out without prior mV calibration.
- A pre-wired jig built using a spare instrument sleeve may help to speed up the calibration procedure especially if a number of instruments are to be calibrated.
- Power should be turned on only after the controller has been inserted in the sleeve of the pre-wired circuit. Power should also be turned off before removing the controller from its sleeve.
- Allow at least 10 minutes for the controller to warm up after switch on.

#### 26.1.2 To Check mV Input Calibration

The input may have been configured for a process input of mV, Volts or mA and scaled in Level 3 as described in section 7.2.6. The example described in section 7.2.6.1 assumes that the display is set up to read 75.0 for an input of 4.000mV and 500.0 for an input of 20.000mV.

To check this scaling, connect a milli-volt source, traceable to national standards, to terminals V+ and V- using copper cable as shown in the diagram below.

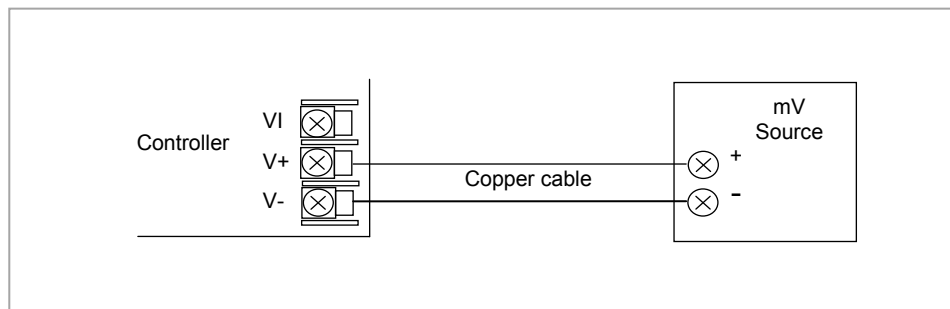

Figure 26-1: Connections for mV Calibration

☺ Ensure that no offsets (see sections 0 and 7.2.8) have been set in the controller.

Set the mV source to 4.000mV. Check the display reads 75.0  $\pm 0.25\% \pm 1\text{LSD}$  (least significant digit).

Set the mV source to 20.000mV. Check the display reads 500.0  $\pm 0.25\% \pm 1\text{LSD}$ .

### 26.1.3 To Check Thermocouple Input Calibration

Connect a milli-volt source, traceable to national standards, to terminals V+ and V- as shown in the diagram below. The mV source must be capable of simulating the thermocouple cold junction temperature. It must be connected to the instrument using the correct type of thermocouple compensating cable for the thermocouple in use.

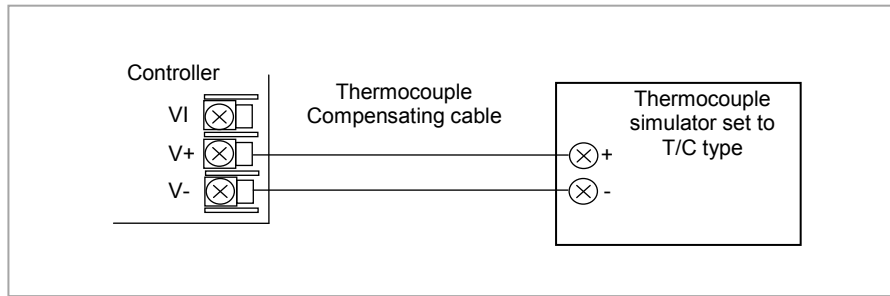

**Figure 26-2: Connections for Thermocouple Calibration**

Set the mV source to the same thermocouple type as that configured in the controller.

Adjust the mV source to the minimum range. For a type J thermocouple, for example, the minimum range is  $-210^{\circ}\text{C}$ . However, if it has been restricted using the Range Low parameter then set the mV source to this limit. Check that the reading on the display is within  $\pm 0.25\%$  of reading  $\pm 1\text{LSD}$ .

Adjust the mV source for to the maximum range. For a type J thermocouple, for example, the maximum range is  $1200^{\circ}\text{C}$ . However, if it has been restricted using the Range High parameter then set the mV source to this limit. Check that the reading on the display is within  $\pm 0.25\%$  of reading  $\pm 1\text{LSD}$ .

Intermediate points may be similarly checked if required.

### 26.1.4 To Check RTD Input Calibration

Connect a decade box with total resistance lower than 1K and resolution to two decimal places in place of the RTD as indicated on the connection diagram below **before the instrument is powered up**. If at any instant the instrument was powered up without this connection then at least 10 minutes must elapse from the time of restoring this connection before RTD calibration check can take place.

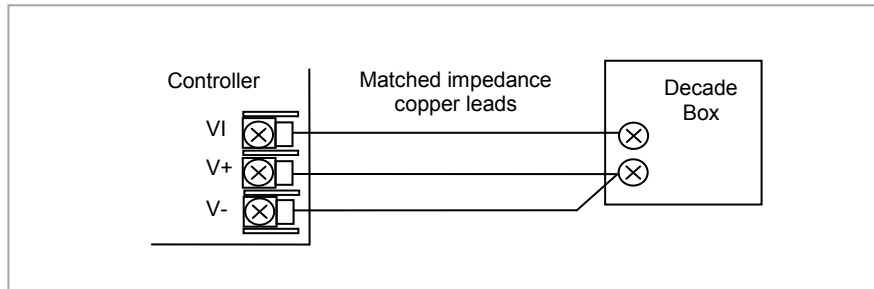

**Figure 26-3: Connections for RTD Calibration**

The RTD range of the instrument is  $-200$  to  $850^{\circ}\text{C}$ . It is, however, unlikely that it will be necessary to check the instrument over this full range.

Set the resistance of the decade box to the minimum range. For example  $0^{\circ}\text{C} = 100.00\Omega$ . Check the calibration is within  $\pm 0.25\%$  of reading  $\pm 1\text{LSD}$ .

Set the resistance of the decade box to the maximum range. For example  $200^{\circ}\text{C} = 175.86\Omega$ . Check the calibration is within  $\pm 0.25\%$  of reading  $\pm 1\text{LSD}$ .

### 26.2 Input Calibration

If the calibration is not within the specified accuracy follow the procedures in this section:-  
 Inputs which can be calibrated:-

- **mV Input.** This is a linear 80mV range calibrated at two fixed points. This should always be done before calibrating either thermocouple or resistance thermometer inputs. mA ranges are included in the mV range.
- **Thermocouple** calibration involves calibrating the temperature offset of the CJC sensor only. Other aspects of thermocouple calibration are also included in mV calibration.
- **Resistance Thermometer.** This is also carried out at two fixed points - 150Ω and 400Ω.

### 26.3 Precautions

Observe the precautions stated in section 26.1.1.

#### 26.3.1 To Calibrate mV Range

Calibration of the mV range is carried out using a 50 milli-volt source, connected as shown in the diagram below. mA calibration is included in this procedure.

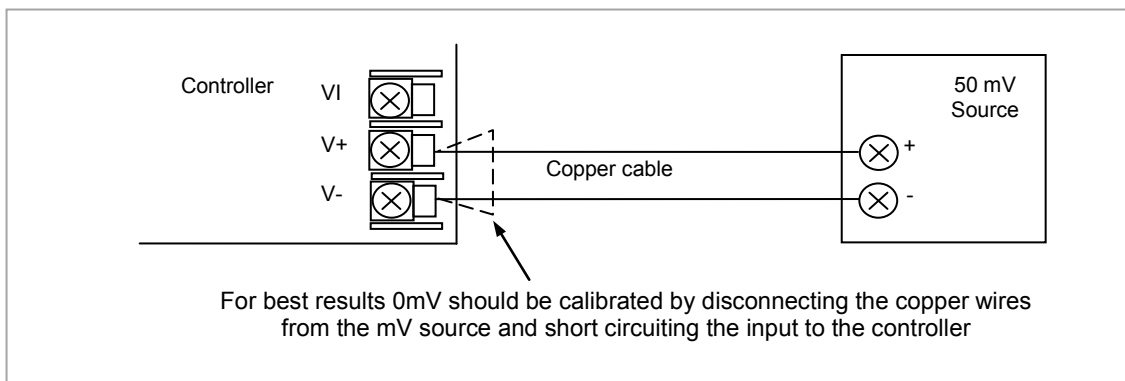

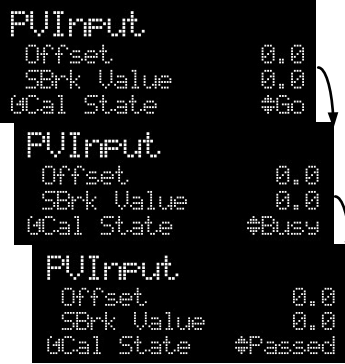













Figure 26-4: Connections for mV Calibration

To calibrate the PV Input:-



Do This	The Display You Should See	Additional Notes
1. From any display press  as many times as necessary to select the input to be calibrated	<pre>PVInput @ID Type    #40 mV Lin Type    Linear Units       None</pre>	This may be 'PVInput' or a 'DC Input' module.
2. Press  to select 'Cal State'	<pre>PVInput Offset      0.0 SBrk Value  0.0 @Cal State  #Idle</pre>	
3. <b>Set mV source for 0mV</b> (or apply a short circuit as indicated).		
4. Press  or  to choose 'Lo-0mV'	<pre>PVInput Offset      0.0 SBrk Value  0.0 @Cal State  #Lo-0mV PVInput Offset      0.0 SBrk Value  0.0 @Cal State  #Confirm</pre>	'Confirm' will automatically be requested.

Do This	The Display You Should See	Additional Notes
5. Press  or  to select 'Go'		<p>The controller will automatically perform the calibration procedure.</p> <p>The calibration can be aborted at any stage. Press  or  to select 'Abort'. After a brief flicker of the display 'Cal State' will return to 'Idle'.</p>
6. Press  or  to 'Accept'		<p>It is also possible to 'Abort' at this stage. The controller then returns to the 'Idle' state.</p> <p>By pressing Accept, this means that the calibration will be used for as long as the controller is switched on. When the controller is switched off the calibration will revert to that set during manufacture.</p> <p>To use the new calibration permanently select 'Save User' as described in the next section</p>
7. <b>Set mV source for 50mV</b> (or remove the short circuit).		
8. Press  or  to select 'Hi-50mV' 9. Now repeat 5 and 6 above to calibrate the high mV range		<p>The controller will again automatically calibrate to the injected input mV.</p> <p>If it is not successful then 'Fail' will be displayed</p>

**26.3.2 To Save the New Calibration Data**

Do This	The Display You Should See	Additional Notes
10. Press  or  to select 'Save User'		<p>The new calibration data will be used following a power down of the controller</p>

**26.3.3 To Return to Factory Calibration**

Do This	The Display You Should See	Additional Notes
11. Press  or  to select 'Load fact'		<p>The factory calibration will be reinstated</p>

**26.3.4 Thermocouple Calibration**



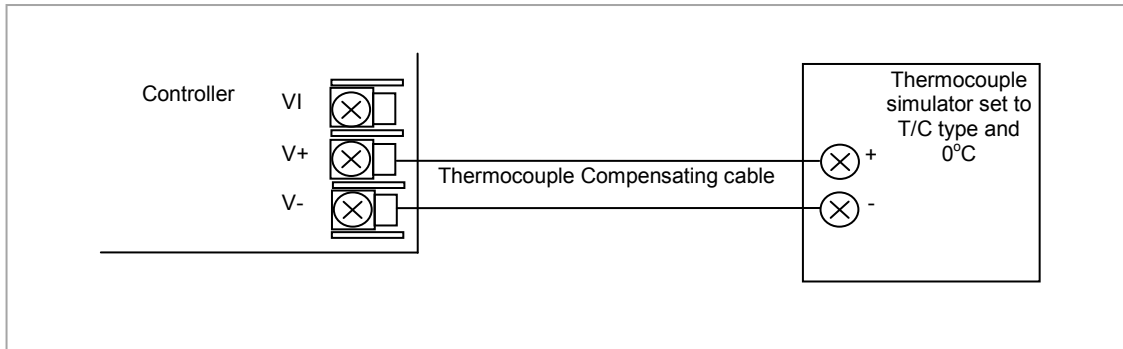

Thermocouples are calibrated, firstly, by following the previous procedure for the mV ranges, then calibrating the CJC.

This can be carried out using an external CJC reference source such as an ice bath or using a thermocouple mV source. Replace the copper cable shown in the previous diagram with the appropriate compensating cable for the thermocouple in use.



**Figure 26-5: Connections for Thermocouple Calibration**

Set the mV source to **internal compensation** for the thermocouple in use and set the output for **0mV**. Then:-

Do This	The Display You Should See	Additional Notes
1. This example is for PV Input configured as a type K thermocouple	<pre>PVInput IO Type  ThermoCpl QLin Type #K Units    None</pre>	
2. From the 'Cal State', press  or  to select 'CJC'	<pre>PVInput SBrk Value  0.0 QCal State  #CJC Status      OK</pre>	
3. Press  or  to select 'Go' 4. The remaining procedure is the same as described in the previous section	<pre>PVInput Offset      0.0 SBrk Value  0.0 QCal State  #Confirm</pre>	The controller automatically calibrates to the CJC input at 0mV.  As it does this the display will show 'Busy' then 'Passed', assuming a successful calibration. If it is not successful then 'Failed' will be displayed. This may be due to an incorrect input mV

**26.3.5 RTD Calibration**

The two points at which the RTD range is calibrated are 150.00Ω and 400.00Ω.

Before starting RTD calibration:

- A decade box with total resistance lower than 1K must be connected in place of the RTD as indicated on the connection diagram below **before the instrument is powered up**. If at any instant the instrument was powered up without this connection then at least 10 minutes must elapse from the time of restoring this connection before RTD calibration can take place.
- The instrument should be powered up for at least 10 minutes.

Before using or verifying RTD calibration:

- The mV range must be calibrated first.

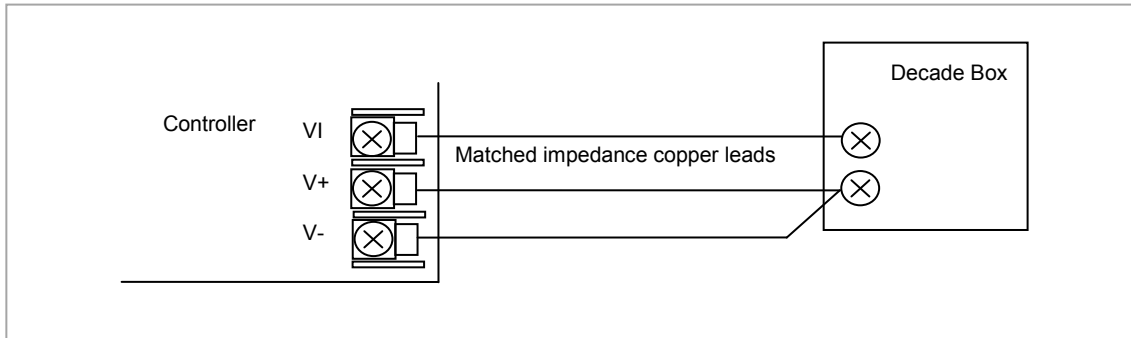

**Figure 26-6: Connections for RTD Calibration**

Do This	The Display You Should See	Additional Notes
1. This example is for PV Input configured as a Pt100 RTD	<pre>PVInput @ID Type      #RTD Lin Type      PT100 Units         AbsTemp</pre>	
2. With 'Cal State' selected, press $\uparrow$ or $\downarrow$ to select 'Lo-150ohm'	<pre>PVInput SBrk Value    0.0 Lead Res      0.0 @Cal State#Lo-150ohm</pre>	
<b>Set the decade box for 150.00Ω</b>		
3. Press $\uparrow$ or $\downarrow$ to choose 'Go'	<pre>PVInput Offset        0.0 SBrk Value    0.0 @Cal State #Confirm</pre>	The controller automatically calibrates to the injected 150.00Ω input. As it does this the display will show 'Busy' then 'Pass', assuming a successful calibration. If it is not successful then 'Failed' will be displayed. This may be due to an incorrect input resistance
<b>Set the decade box for 400.00Ω</b>		
4. Repeat the procedure for 'Hi-400ohm'	<pre>PVInput SBrk Value    0.0 Lead Res      0.0 @Cal State#Hi-400ohm</pre>	The calibration data can be saved or you can return to Factory Calibration as described in sections 26.3.2 and 26.3.3.

## 26.4 Calibration Parameters

The following table lists the parameters available in the Calibration List.

List Header - PV Input		Sub-headers: None			
Name ⊙ to select	Parameter Description	Value Press ▼ or ▲ to change values		Default	Access Level
Cal State	Calibration state of the input	Idle	Normal operation	Idle	Conf L3 R/O
		Lo-0mv	Low input calibration for mV ranges		
		Hi-50mV	High input calibration for mV ranges		
		Lo-0v	Low input calibration for V/Thermocouple ranges		
		Hi-8V	High input calibration for V/thermocouple ranges		
		Lo-0v	Low input calibration for HZ Volts range		
		Hi-1V	High input calibration for HZ Volts range		
		Lo-150ohm	Low input calibration for RTD range		
		Hi-400ohm	High input calibration for RTD range		
		Load Fact	Restore factory calibration values		
		Save User	Save the new calibration values		
		Confirm	To start the calibration procedure when one of the above has been selected		
		Go	Starting the automatic calibration procedure		
		Busy	Calibration in progress		
		Passed	Calibration successful		
		Failed	Calibration unsuccessful		

The above list shows the parameters which appear during a normal calibration procedure. The full list of possible values follows – the number is the enumeration for the parameter.

- 1: Idle
- 2: Low calibration point for Volts range
- 3: High calibration point for Volts range
- 4: Calibration restored to factory default values
- 5: User calibration stored
- 6: Factory calibration stored
- 11: Idle
- 12: Low calibration point for HZ input
- 13: High calibration point for the HZ input
- 14: Calibration restored to factory default values
- 15: User calibration stored
- 16: Factory calibration stored
- 20: Calibration point for factory rough calibration
- 21: Idle
- 22: Low calibration point for the mV range
- 23: Hi calibration point for the mV range
- 24: Calibration restored to factory default values
- 25: User calibration stored
- 26: Factory calibration stored
- 30: Calibration point for factory rough calibration
- 31: Idle
- 32: Low calibration point for the mV range
- 33: High calibration point for the mV range
- 34: Calibration restored to factory default values
- 35: User calibration stored
- 36: Factory calibration stored
- 41: Idle



- 42: Low calibration point for RTD calibration (150 ohms)
- 43: Low calibration point for RTD calibration (400 ohms)
- 44: Calibration restored to factory default values
- 45: User calibration stored
- 46: Factory calibration stored
- 51: Idle
- 52: CJC calibration used in conjunction with Term Temp parameter
- 54: Calibration restored to factory default values
- 55: User calibration stored
- 56: Factory calibration stored
- 200: Confirmation of request to calibrate
- 201: Used to start the calibration procedure
- 202: Used to abort the calibration procedure
- 210: Calibration point for factory rough calibration
- 212: Indication that calibration is in progress
- 213: Used to abort the calibration procedure
- 220: Indication that calibration completed successfully
- 221: Calibration accepted but not stored
- 222: Used to abort the calibration procedure
- 223: Indication that calibration failed

## 26.5 Valve Position Output Calibration

Calibration of the VP output is associated with whichever digital output has been configured to drive the valve. Suitable outputs are the Logic IO, Relay, Logic or Triac Output Module. The calibration of the VP output is described in section 8.2.4.

If a feedback potentiometer is being used, the calibration of this is performed in the Potentiometer Input Module and is described in section 10.4.5.

## 26.6 DC Output and Retransmission Calibration

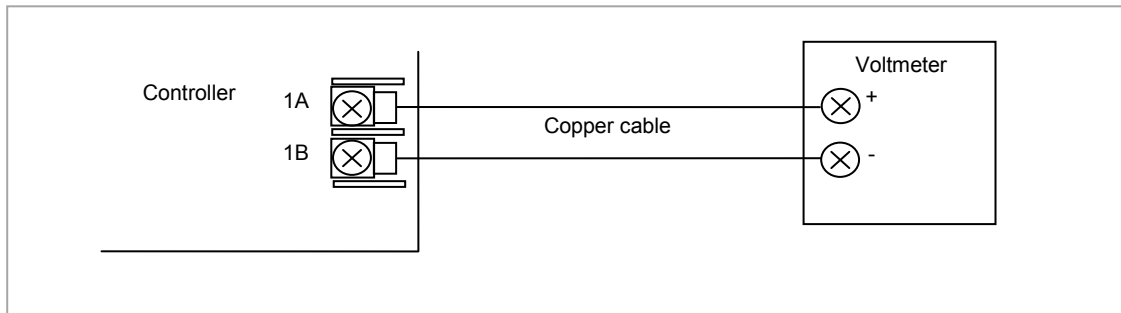

**Figure 26-7: Calibration of DC Output Module**

The following procedure is particularly relevant to retransmission outputs where the absolute value of the output must correspond with the device (such as a chart recorder) being used to monitor the retransmitted value.

Connect a voltmeter to the output to be calibrated. The example shown in Figure 26-7 shows position 1 fitted with a DC Output module.

Select Configuration level.

1. Press to select the list header for the module to be calibrated. In this example '**Mod 1A**'
2. Press to scroll to '**Cal State**'
3. Press or to select '**Lo**' to calibrate the low point. Then '**Confirm**', then '**Go**'.
4. '**Trim**' will be shown.
5. Press again to scroll to '**Cal Trim**'
6. Press or to adjust the value read by the voltmeter to **1.00V**. The value shown on the controller display is arbitrary and has the range -32768 to 32767.
7. Return to '**Cal State**'. This can be done by pressing followed by .
8. Press or to '**Accept**'. The display will return to '**Idle**'.
  - a. It is now necessary to calibrate the high point.
9. Press or to select '**Hi**' to calibrate the high point. Then '**Confirm**', then '**Go**'.
10. '**Trim**' will be shown.
11. Press again to scroll to '**Cal Trim**'
12. Press or to adjust the value read by the voltmeter to **9.00V**. The value shown on the controller display is arbitrary and has the range -32768 to 32767.
13. Return to '**Cal State**'. This can be done by pressing followed by .
14. Press or to '**Accept**'. The display will return to '**Idle**'.
15. The above procedure should be repeated for all retransmission outputs.

## 27. Chapter 27 Configuration Using iTools

Configuration of the instrument which has been described so far in this manual has been through the user interface of the controller. iTools provides a software platform for configuring Eurotherm instruments and also allows additional functions, such as naming of certain parameters and creating User Pages, to be performed. This chapter gives an introduction to using iTools to configure 3500 series instruments.

Further details are available in the iTools Help Manual Part No. HA028838 which can be downloaded from [www.eurotherm.co.uk](http://www.eurotherm.co.uk).

### 27.1 Features

- Parameter Set up
- Device Operation
- Device Recipe
- Program Editing
- Configuration of User Pages
- Graphical Wiring
- Cloning

### 27.2 On-Line/Off-line Editing

If you open the editor on a real device then all the changes you make will be written to the device immediately. All the normal instrument rules apply so you will be able to make the same changes to the parameters of a running instrument that you could make using its front panel.

If you open a program file or open the Programmer Editor on a simulation you will need to save the program or send it to a real device.

Offline programming is actually done using an instrument simulation that can hold as many programs as a real instrument. If you wish to create a set of programs which will all be used in a single instrument you can create a new program and then change the program number using the spin control and edit another program. Each program must be saved separately. If you make a change to one program and switch to another program you will be prompted to save that program.

### 27.3 Connecting a PC to the Controller

The controller may be connected to the PC running iTools using the EIA232 or EIA485 communications digital communications ports H or J as shown in section 1.8.1. Alternatively, using the IR clip or configuration clip as shown in section 14.2

### 27.4 To Scan for Connected Instruments

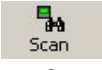
Open iTools and, with the controller connected, press  on the iTools menu bar. iTools will search the communications ports and TCP/IP connections for recognisable instruments. Controllers connected with the configuration clip (CPI), will be found at address 255 regardless of the address configured in the controller.

The iTools Help Manual, part no. HA028838, provides further step by step instructions on the general operation of iTools. This and the iTools software may be downloaded from [www.eurotherm.co.uk](http://www.eurotherm.co.uk).

In the following pages it is assumed that the user is familiar with these instructions and has a general understanding of Windows.

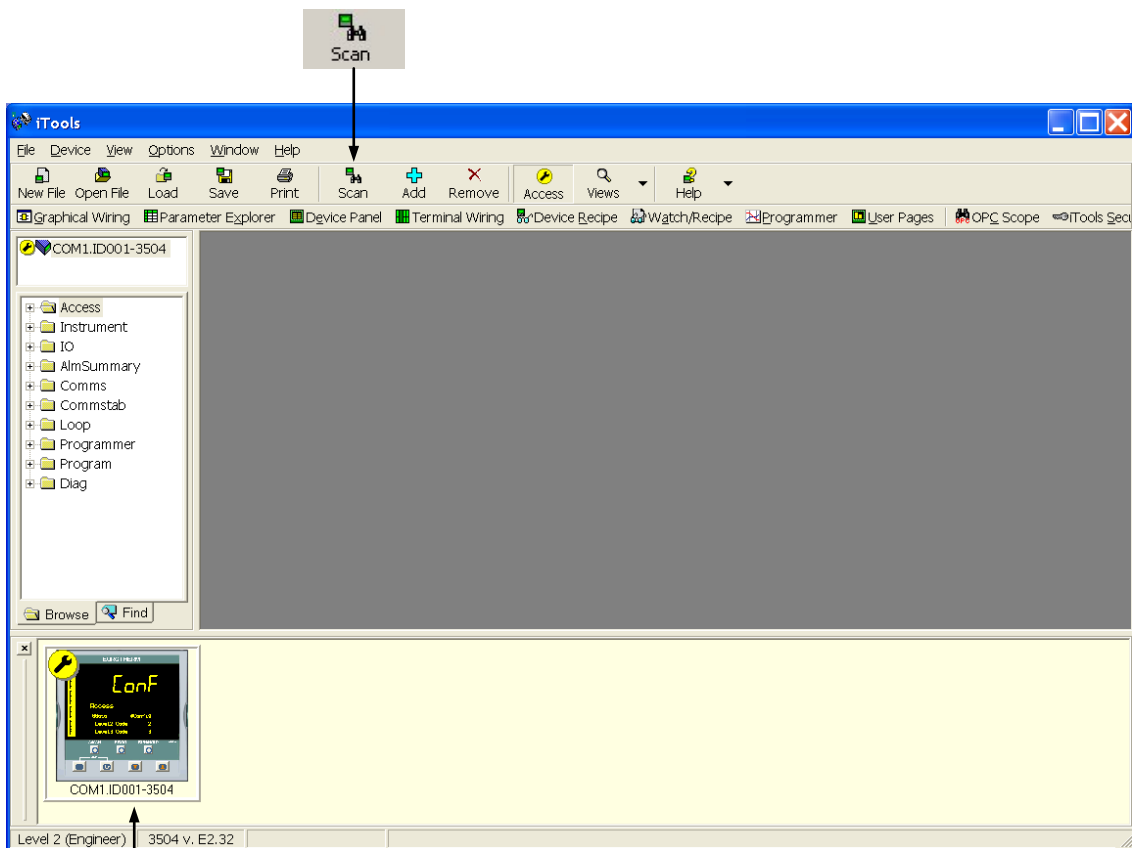

In the View menu select Panel Views to show the controller fascia.



Press  to change the controller between operator and configuration levels.

Figure 27-1: Opening View

## 27.5 Parameter Set Up

Allows parameters to be configured.

1. Press  Parameter Explorer or double click the folder in the browser to get this view
2. Open up the parameter list by clicking on the required folder. Double clicking another folder will open more parameter lists. Right click in the parameter list to reveal or hide columns.
3. To change the analogue value of a parameter, double click the parameter and change its value. To change the value of an enumerated parameter open the drop down menu and use the pop-up window
4. The 'Access' button puts the controller into configuration mode. In this mode the controller can be set up without its outputs being active. Press 'Access' again to return to operating level.
5. The instrument view is optional. Select 'Panel Views' in the 'View' menu.
6. To find a parameter select the 'Find' tab

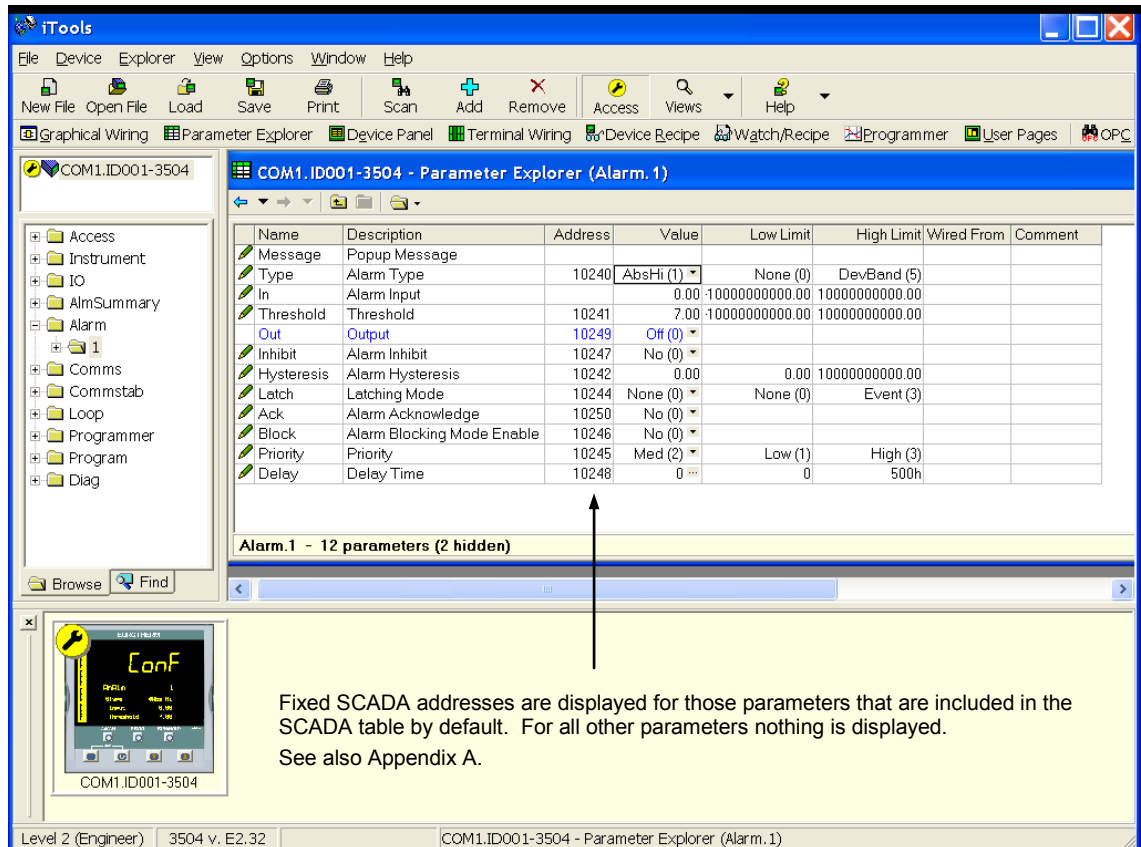

The screenshot shows the iTools software interface. The main window is titled "COM1.ID001-3504 - Parameter Explorer (Alarm.1)". The left-hand pane shows a tree view with folders for Access, Instrument, IO, AlmSummary, Alarm, Comms, Commstab, Loop, Programmer, Program, and Diag. The main pane displays a table of parameters for Alarm 1. The table has columns for Name, Description, Address, Value, Low Limit, High Limit, Wired From, and Comment. The parameters listed are:

Name	Description	Address	Value	Low Limit	High Limit	Wired From	Comment
Message	Popup Message						
Type	Alarm Type	10240	AbsHi (1)	None (0)	DevBand (5)		
In	Alarm Input		0.00	-10000000000.00	10000000000.00		
Threshold	Threshold	10241	7.00	-10000000000.00	10000000000.00		
Out	Output	10249	Off (0)				
Inhibit	Alarm Inhibit	10247	No (0)				
Hysteresis	Alarm Hysteresis	10242	0.00	0.00	10000000000.00		
Latch	Latching Mode	10244	None (0)	None (0)	Event (3)		
Ack	Alarm Acknowledge	10250	No (0)				
Block	Alarm Blocking Mode Enable	10246	No (0)				
Priority	Priority	10245	Med (2)	Low (1)	High (3)		
Delay	Delay Time	10248	0	0	500h		

Below the table, it says "Alarm.1 - 12 parameters (2 hidden)". At the bottom of the window, there is a status bar showing "Level 2 (Engineer)", "3504 v. E2.32", and "COM1.ID001-3504 - Parameter Explorer (Alarm.1)".

Fixed SCADA addresses are displayed for those parameters that are included in the SCADA table by default. For all other parameters nothing is displayed. See also Appendix A.

Figure 27-2: Parameters in the Alarm 1 Folder

The example above shows how to configure Alarm 1 as an Absolute High with a threshold of 7.00 units.

## 27.6 Device Panel

Press  Device Panel for this feature. The Panel displays the active instrument panel. This can be used for remote viewing, diagnostics or Training. iTools can be used OFF-LINE to configure the product. The panel view gives an indication of how the instrument will appear when the configuration is downloaded.

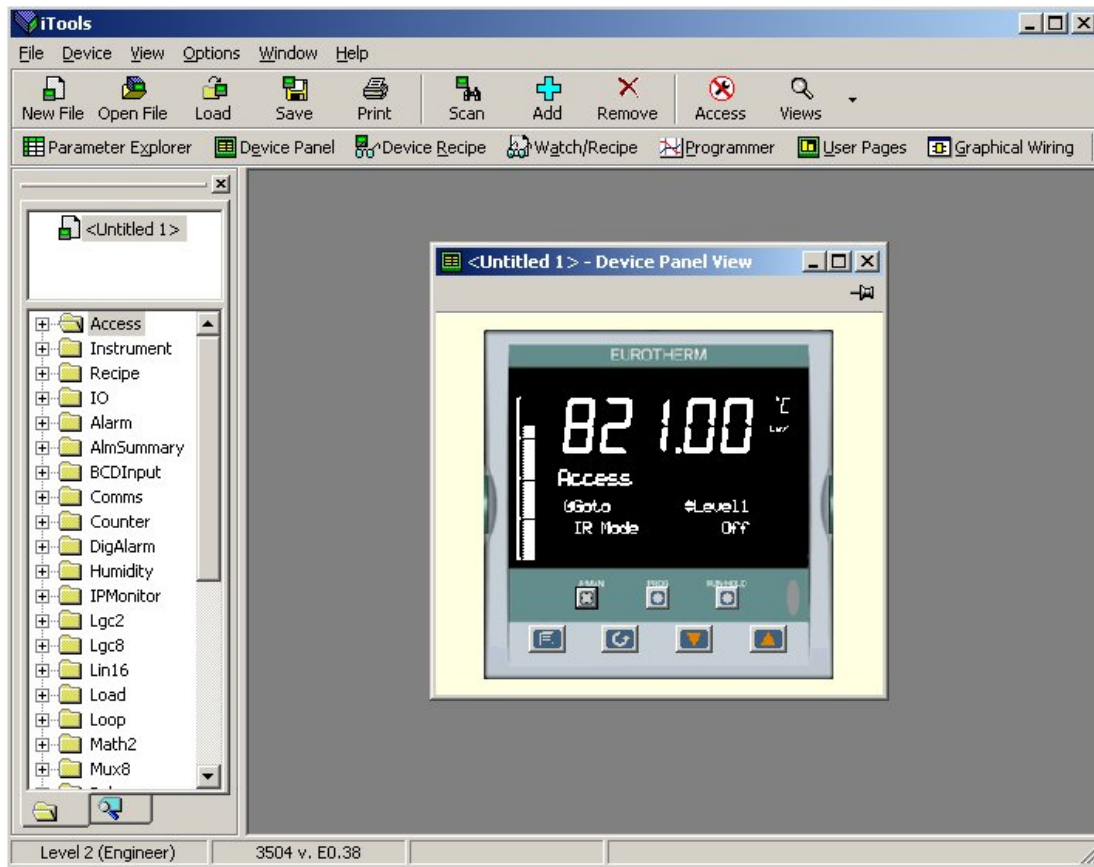

**Figure 27-3: Instrument Display Simulation**

The front panel control buttons, shown in the Device Panel display, are active and clicking on them with the mouse will cause the display to behave as a real instrument.

☺ Clicking on the Page button, , with Ctrl pressed emulates pressing the page and scroll buttons together.

### 27.7 User Pages Editor

Up to 8 User Pages with a total of 64 lines can be created and downloaded into the controller so that the controller display shows only the information which is of interest to the user.

Press  **User Pages** to select this feature

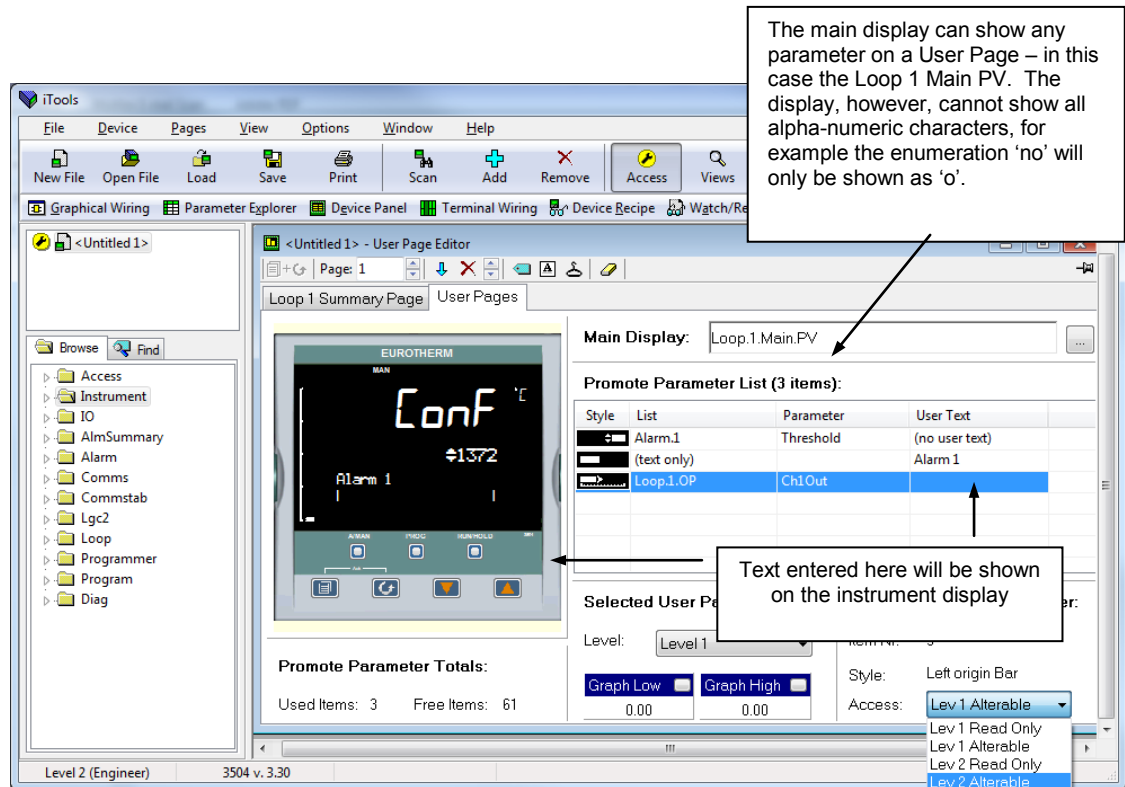
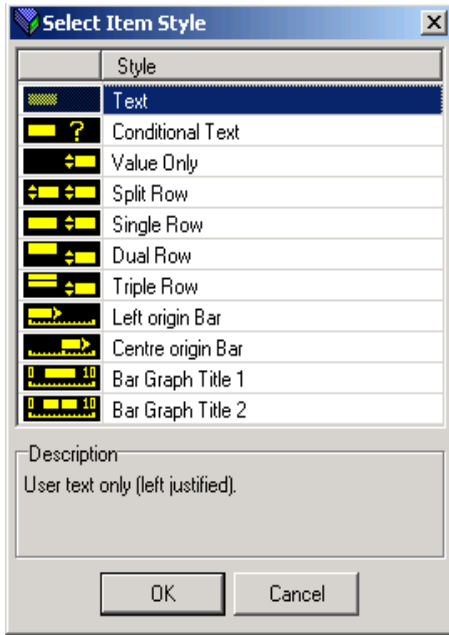

Figure 27-4: User Pages Editor

The Access box at the bottom right has the following enumerations and meanings:

Enumeration	Level 1	Level 2	Level 3
Lev 1 Read Only	Read only	Read/Write	Read/Write
Lev 1 Alterable	Read/Write	Read/Write	Read/Write
Lev 2 Read Only	Hidden	Read only	Read/Write
Lev 2 Alterable	Hidden	Read/Write	Read/Write

**27.7.1 To Create a User Page**



1. Press **Page: 1** to select the page number, 1 to 8
2. Double click in the first row of the table to the right of the instrument display
3. The pop up window shows a list of styles
4. Choose the style then select the parameter from the pop up list. To enter user text (where applicable) either right click or double click under 'User Text'. If the style is text only you will be prompted to enter this as soon as the style is selected.
5. Right click in the list to:-
  - a. Insert an item
  - b. Remove an item
  - c. Edit Wire. Allows you to change the parameter selected
  - d. Edit Text. Allows you to enter your own text for the parameter displayed
  - e. Edit Style. This is shown in the pop up window
  - f. Read Parameter Properties
  - g. Open Parameter Help

6. Select the operator level at which the user page will be displayed

7. If a bar graph is displayed set the low and high graph axes

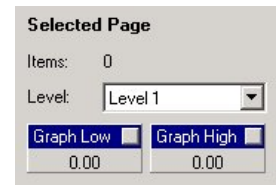

8. Select the Level in which the User Page is Read Only, Read/Write or Hidden



The format of the user page is shown in the instrument view















The user page can now be saved and downloaded to the instrument.



























An alternative way to create a User Page is to drag and drop the required parameter from the parameter list into the appropriate row. The example in the next section shows this.



### 27.7.2 Style Examples

The following examples show the controller display produced for each individual style entered.

Select Item Style	Action	Controller Display												
<p>1.  Text</p>	<p>Text entered will appear on the first line of the controller display. E.g.</p> <table border="1"> <thead> <tr> <th>Style</th> <th>List</th> <th>Parameter</th> <th>User Text</th> </tr> </thead> <tbody> <tr> <td></td> <td>(text only)</td> <td></td> <td>Primary Process</td> </tr> </tbody> </table> <p>Further lines of text may be added. Up to four lines will be shown on the controller display at any time.</p> <p>Use  to scroll through the text on the controller display</p>	Style	List	Parameter	User Text		(text only)		Primary Process					
Style	List	Parameter	User Text											
	(text only)		Primary Process											
<p>2.  Conditional Text</p>	<p>Text entered will only be shown if a condition is true. e.g.</p> <table border="1"> <thead> <tr> <th>Style</th> <th>List</th> <th>Parameter</th> <th>User Text</th> </tr> </thead> <tbody> <tr> <td></td> <td>IO.LgcIO.LA</td> <td>PV</td> <td>Too Hot</td> </tr> </tbody> </table> <p>The text only appears when the logic input on LA is true</p>	Style	List	Parameter	User Text		IO.LgcIO.LA	PV	Too Hot					
Style	List	Parameter	User Text											
	IO.LgcIO.LA	PV	Too Hot											
<p>3.  Value Only</p>	<p>The value of the chosen parameter will be displayed in the first and subsequent rows. E.g.</p> <table border="1"> <thead> <tr> <th>Style</th> <th>List</th> <th>Parameter</th> <th>User Text</th> </tr> </thead> <tbody> <tr> <td></td> <td>Loop.1.Main</td> <td>PV</td> <td>(no user text)</td> </tr> </tbody> </table> <p>This style does not have user text</p>	Style	List	Parameter	User Text		Loop.1.Main	PV	(no user text)					
Style	List	Parameter	User Text											
	Loop.1.Main	PV	(no user text)											
<p>4.  Split Row</p>	<p>The value of a parameter may be displayed to the left and to the right of the controller display. The following example shows the entry set up for digital inputs LA and Lb</p> <table border="1"> <thead> <tr> <th>Style</th> <th>List</th> <th>Parameter</th> <th>User Text</th> </tr> </thead> <tbody> <tr> <td></td> <td>IO.LgcIO.LA</td> <td>PV</td> <td>LA</td> </tr> <tr> <td></td> <td>IO.LgcIO.LB</td> <td>PV</td> <td>LB</td> </tr> </tbody> </table>	Style	List	Parameter	User Text		IO.LgcIO.LA	PV	LA		IO.LgcIO.LB	PV	LB	
Style	List	Parameter	User Text											
	IO.LgcIO.LA	PV	LA											
	IO.LgcIO.LB	PV	LB											
<p>5.  Single Row</p>	<p>The value of the parameter will be displayed on the right side of the user page. To customise the text, right click in the field shown below and select Edit Text</p> <table border="1"> <thead> <tr> <th>Style</th> <th>List</th> <th>Parameter</th> <th>User Text</th> </tr> </thead> <tbody> <tr> <td></td> <td>Alarm.1</td> <td>Threshold</td> <td>Al 1 Trip</td> </tr> </tbody> </table>	Style	List	Parameter	User Text		Alarm.1	Threshold	Al 1 Trip					
Style	List	Parameter	User Text											
	Alarm.1	Threshold	Al 1 Trip											
<p>6.  Dual Row</p>	<p>The value of a parameter and a user defined label may be displayed on two lines of the controller display. The following example shows the entry set up for digital inputs LA and Lb</p> <table border="1"> <thead> <tr> <th>Style</th> <th>List</th> <th>Parameter</th> <th>User Text</th> </tr> </thead> <tbody> <tr> <td></td> <td>IO.LgcIO.LB</td> <td>PV</td> <td>LA</td> </tr> <tr> <td></td> <td>IO.LgcIO.LA</td> <td>PV</td> <td>LB</td> </tr> </tbody> </table>	Style	List	Parameter	User Text		IO.LgcIO.LB	PV	LA		IO.LgcIO.LA	PV	LB	
Style	List	Parameter	User Text											
	IO.LgcIO.LB	PV	LA											
	IO.LgcIO.LA	PV	LB											
<p>7.  Triple Row</p> <p><a href="#">See Note 1</a></p>	<p>The description can be up to 20 characters long and is spread between the first two lines on the display. The parameter value appears on the third line.</p> <table border="1"> <thead> <tr> <th>Style</th> <th>List</th> <th>Parameter</th> <th>User Text</th> </tr> </thead> <tbody> <tr> <td></td> <td>Lgc2.1</td> <td>In1</td> <td>Up to 16 characters</td> </tr> </tbody> </table>	Style	List	Parameter	User Text		Lgc2.1	In1	Up to 16 characters					
Style	List	Parameter	User Text											
	Lgc2.1	In1	Up to 16 characters											

<p>8.  Left origin Bar</p>	<p>This places a bar graph to the left of the display with user text to the right. Keep the user text length to a minimum.</p> <table border="1" data-bbox="507 257 949 309"> <thead> <tr> <th>Style</th> <th>List</th> <th>Parameter</th> <th>User Text</th> </tr> </thead> <tbody> <tr> <td></td> <td>Loop.1.SP</td> <td>SP1</td> <td>Temp</td> </tr> </tbody> </table> <p>Do not forget to set up the Graph Low and High limits</p>	Style	List	Parameter	User Text		Loop.1.SP	SP1	Temp					
Style	List	Parameter	User Text											
	Loop.1.SP	SP1	Temp											
<p>9.  Centre origin Bar</p>	<p>This places a bar graph with centre origin to the left of the display with user text to the right. Keep the user text length to a minimum.</p> <table border="1" data-bbox="507 481 949 533"> <thead> <tr> <th>Style</th> <th>List</th> <th>Parameter</th> <th>User Text</th> </tr> </thead> <tbody> <tr> <td></td> <td>Loop.1.Diag</td> <td>Error</td> <td>Error</td> </tr> </tbody> </table> <p>Do not forget to set up the Graph Low and High limits</p>	Style	List	Parameter	User Text		Loop.1.Diag	Error	Error					
Style	List	Parameter	User Text											
	Loop.1.Diag	Error	Error											
<p>10.  Bar Graph Title 1</p>	<p>This adds Text, Graph Low and High Limits only. If this is associated with a parameter the name of the parameter is used as the text. The text is truncated if too long</p> <p>It is necessary to add the bar graph as a separate item.</p> <table border="1" data-bbox="507 795 949 878"> <thead> <tr> <th>Style</th> <th>List</th> <th>Parameter</th> <th>User Text</th> </tr> </thead> <tbody> <tr> <td></td> <td>(text only)</td> <td></td> <td>Pressure</td> </tr> <tr> <td></td> <td>Loop.1.SP</td> <td>SP1</td> <td></td> </tr> </tbody> </table>	Style	List	Parameter	User Text		(text only)		Pressure		Loop.1.SP	SP1		
Style	List	Parameter	User Text											
	(text only)		Pressure											
	Loop.1.SP	SP1												
<p>11.  Bar Graph Title 2</p>	<p>This adds centre zero value (0.00) to the bar graph plus text. The display will show graph limits, text and the parameter value. If this takes up too many characters then priority is given first to the value, then to the text, then to the limits.</p> <table border="1" data-bbox="507 1052 949 1135"> <thead> <tr> <th>Style</th> <th>List</th> <th>Parameter</th> <th>User Text</th> </tr> </thead> <tbody> <tr> <td></td> <td>Loop.1.Diag</td> <td>Error</td> <td>Err</td> </tr> <tr> <td></td> <td>Loop.1.Main</td> <td>PV</td> <td></td> </tr> </tbody> </table>	Style	List	Parameter	User Text		Loop.1.Diag	Error	Err		Loop.1.Main	PV		
Style	List	Parameter	User Text											
	Loop.1.Diag	Error	Err											
	Loop.1.Main	PV												



**Note 1:**

A user page is produced by adding styles one after another. Generally this can be made in any order. However, the default style of 3500 series displays is to show a heading in the first line of the alpha numeric section, followed by a list of parameters and their descriptions - the scroll button being used in operator mode to select parameters. When producing a user page, it is recommended that this default style is followed avoid confusion during operation.

In the case of a Triple Line display, if this placed as the first item in the user page, the first line (of user text) takes up the title space. If another Triple Line style follows this you will be unable to scroll to this in operator mode. To avoid this make the first line a title (using 'Text' style)

### 27.7.3 Immediate Programmer Setpoint

A parameter 'ImmPSP' is available in iTools which can be promoted to a User Page on the controller display. It is identical to the normal PSP except that changes using the raise/lower buttons on the front panel take immediate effect. A typical application is where it required to nudge the setpoint gradually up or down, for example, in crystal growing applications.

It must first be enabled. Select the Programmer Setup page followed by EnableImmSP.

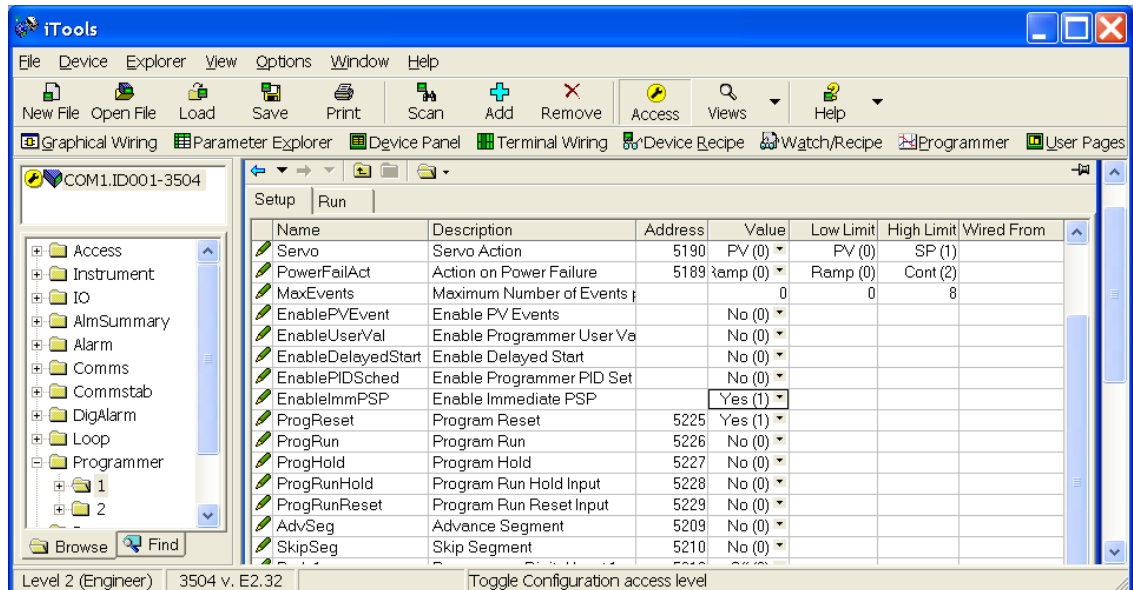

Figure 27-5: To Enable Immediate Programmer Setpoint

To Promote to a User Page:-

1. Select Programmer Run page.

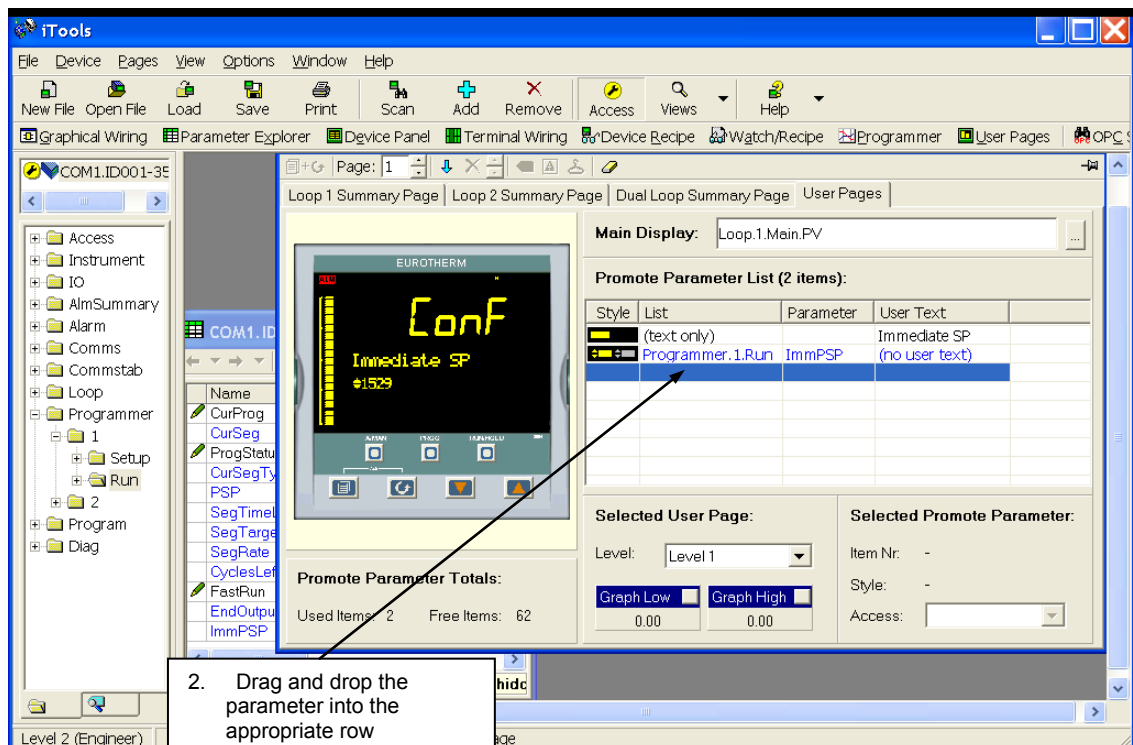

Figure 27-6: Place Immediate Programmer Setpoint on a User Page

This parameter can now be changed from the User Page on the controller when the programmer is in Hold.

## 27.8 Recipe Editor

Up to 8 recipes can be stored. They can also be named by the user. Recipes allow the operator to change the operating values of up to 24 parameters in an instrument for different batches or processes by simply selecting a particular recipe to load. Recipes are important for reducing error in setup and they remove the need for operator instructions fixed to the panel next to the instrument.

The Recipe Editor is used during configuration to assign the required parameters and to set up the values to be loaded for each recipe.

### 27.8.1 To Set Up a Recipe

1. Press . The view shown below will be seen. Each tag represents a parameter

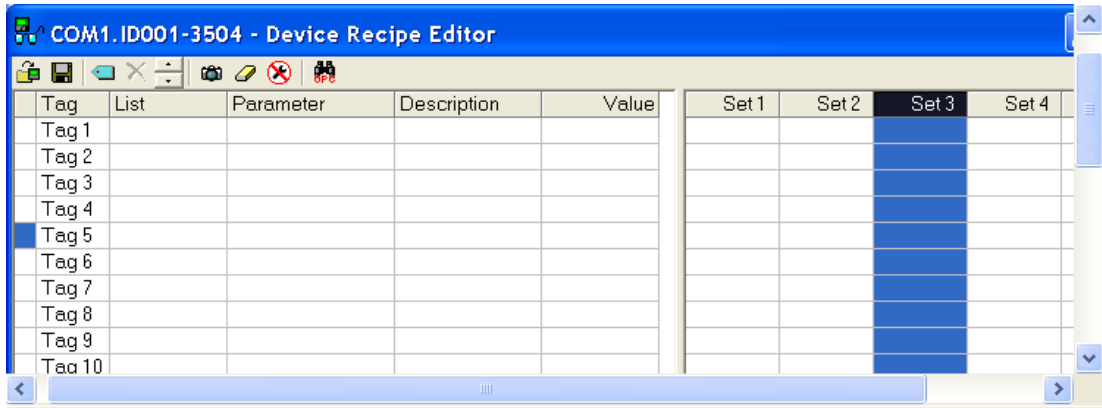

Figure 27-7: No Recipes Set Up

2. **Name the recipe set.** Right click in the required 'Set' column. Select Rename Data Set and enter a name for the recipe

Other commands are:-

**Load Access Level.** This sets the access level in which the recipe can be loaded.

**Snapshot values.** This selects the currently running parameter values in the selected recipe

**Clear data set.** This removes the current values from the selected recipe

**Copy Data Set.** Parameter values are copied from the selected set. The Paste command becomes available.

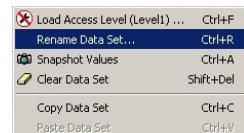

3. **Select Parameters.** Select the tag, right click or click . Select the parameter from the browser list.

The view below shows four recipes named 'Blue', 'Red', 'Green' and 'Set 4' (which has not been re-named) and is a copy of 'Green'. The values may be entered individually in the relevant field or snapshot all current values.

The **Comment** column may be hidden or revealed by selecting '**Columns**' in the pop up. A comment may simply be typed into the field.

- ☺ Some parameters, such as Target SP, which cannot be wired cannot be put into recipe. In this case an error message is displayed.

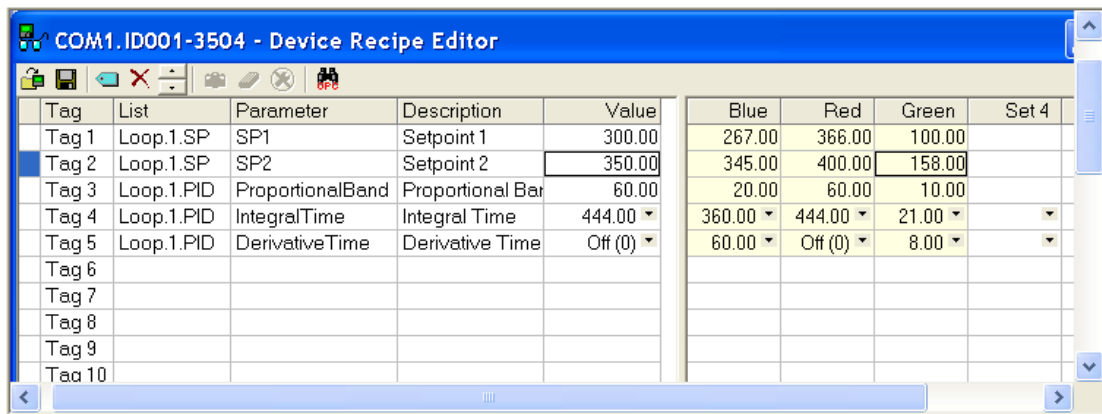
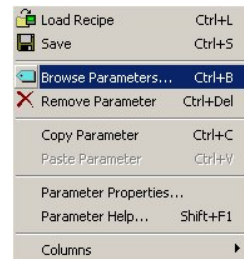

Figure 27-8: Example of Three Simple Recipes

## 27.8.2 Recipe Menu Commands

<b>Load Recipe</b>	Used to load a recipe file into the instrument
<b>Save</b>	Used to save the current recipe configuration into a file
<b>Edit Parameter</b>	Used to assign a parameter to a Tag. Parameters can also be assigned by 'drag and drop' from the iTools parameter list
<b>Delete Parameter</b>	Used to delete an assigned parameter from the recipes
<b>Edit Parameter Value</b>	Used to edit the current value of the assigned parameter
<b>Rename Parameter Tag</b>	Allows the user to rename the Tag of the associated parameter. This tag is used on the instrument to identify assigned parameters (default Value1 - Value24)
<b>Parameter Properties</b>	Used to find the properties and help information of the selected parameter
<b>Copy Parameter</b>	Used to copy the currently selected parameter
<b>Paste Parameter</b>	Used to assign a previously copied parameter to the selected Tag
<b>Columns</b>	Used to hide/show the Description and Comment Columns
<b>Load Access Level</b>	Used to configure the lowest access level in which the selected recipe is allowed to load
<b>Level1</b>	Permitted to load when the instrument is in any of the access levels
<b>Level2</b>	Permitted to load when the instrument is in Level2, Level3 or Config access levels
<b>Level3</b>	Permitted to load when the instrument is in Level3 or Config access levels
<b>Config</b>	Permitted to load when the instrument is in the Config access level
<b>Never</b>	Never permitted to load



**Note:**

Over comms, whilst the instrument is in operator mode, recipes that have been configured to load in Levels 1, 2 and 3 can be loaded. Whilst the instrument is in Config mode all recipes can be loaded.

<b>Edit Data Set Value</b>	Used to edit the value of the selected assigned parameter within the selected recipe. Values can also be edited via double left clicking the value itself
<b>Clear Data Set Value</b>	Used to clear the value of the selected assigned parameter within the selected recipe, thus disabling it from loading when the recipe is selected to load
<b>Rename Data Set</b>	Allows the user to rename the selected recipe. This name is used to identify individual recipes (default Set1 - Set8). 😊 The number of recipes is dependent upon features
<b>Clear Data Set</b>	Used to clear all values in the selected recipe, thus disabling all from loading when the recipe is selected to load
<b>Snapshot Values</b> 	Used to copy all of the assigned parameters current values into the selected recipe
<b>Copy Data Set</b>	Used to copy all values of the selected recipe
<b>Paste Data Set</b>	Used to paste all values of a previously copied recipe into the selected recipe

## 27.8.3 Watch Recipe

The Watch Recipe editor is set up in the same way as the Device Recipe editor. The difference between the Device Recipe and the Watch Recipe editors is that with the Device Recipe, the parameters and data sets are stored as parameters on the device, whereas the Watch/Recipe window is a file-based system. Unlike the Watch/Recipe window, the downloading of data values to their corresponding parameters can be performed from the device front panel without the need for iTools to be running.

## 27.9 To Set up Alarms

### 27.9.1 Example: To Customise Analogue Alarm Messages

- Double click on the **'Alarm'** folder to display the Parameter Explorer. With the controller in configuration mode enter a name for the alarm in the **'Message'** value, in this case 'Too Hot'.
- If the alarm has not been set up, then, with the controller in configuration level, double click on **'Type'** and select the alarm type from the pull down menu.
- Repeat for all other parameters. Parameters shown in blue (in iTools) are not alterable in the current operating level of the instrument.
- In the User Page Editor - Text Only Style - select the parameter 'Message' form the Alarm page. This text will be displayed on the controller when the alarm occurs. This is shown in the simulation below.

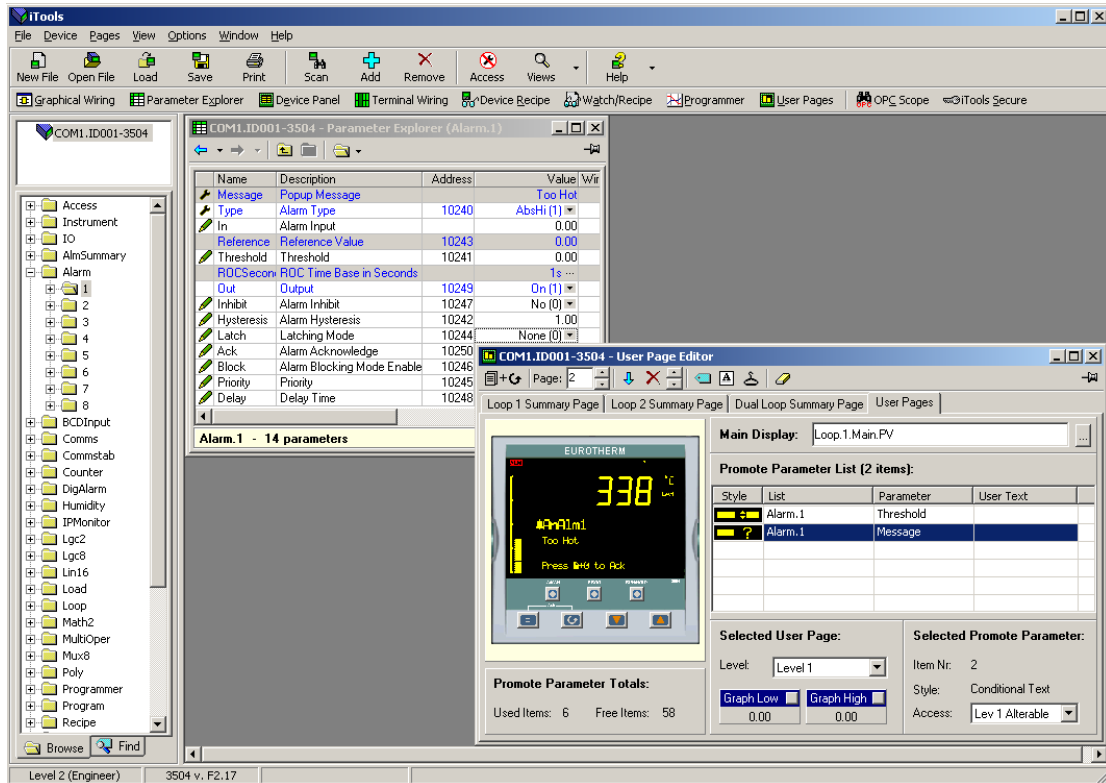

Figure 27-9: To Configure Analogue Alarms

### 27.9.2 Alarm Summary Page

Click on the folder 'AlmSummary'. A list of alarm states is displayed. In the view below the Limits column and Comment column have been opened by right clicking in the parameter list and selecting 'Columns' in the drop down menu.

To add a comment, select 'Add Parameter Comment' from the same drop down and enter the required text.

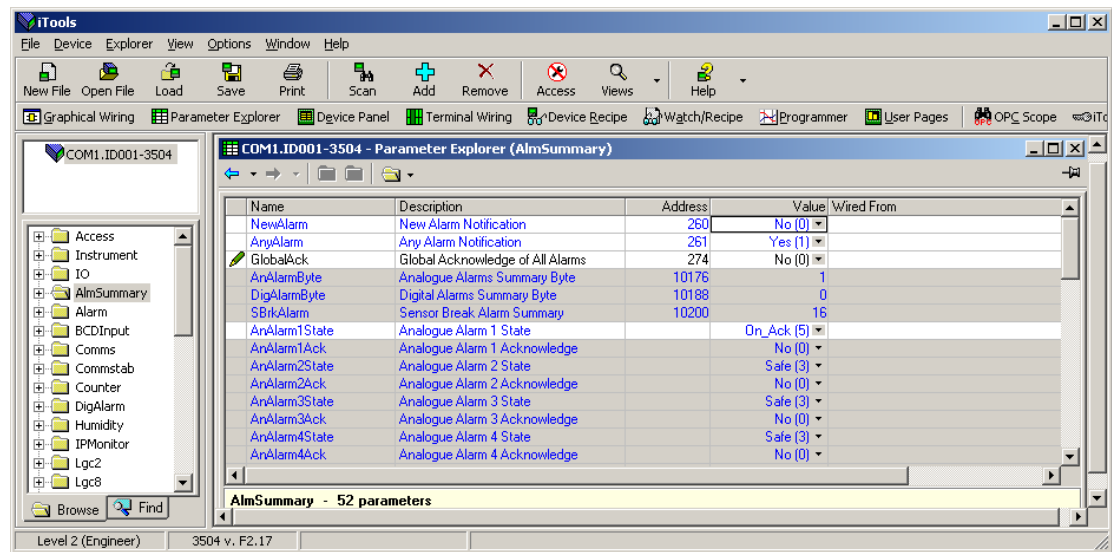
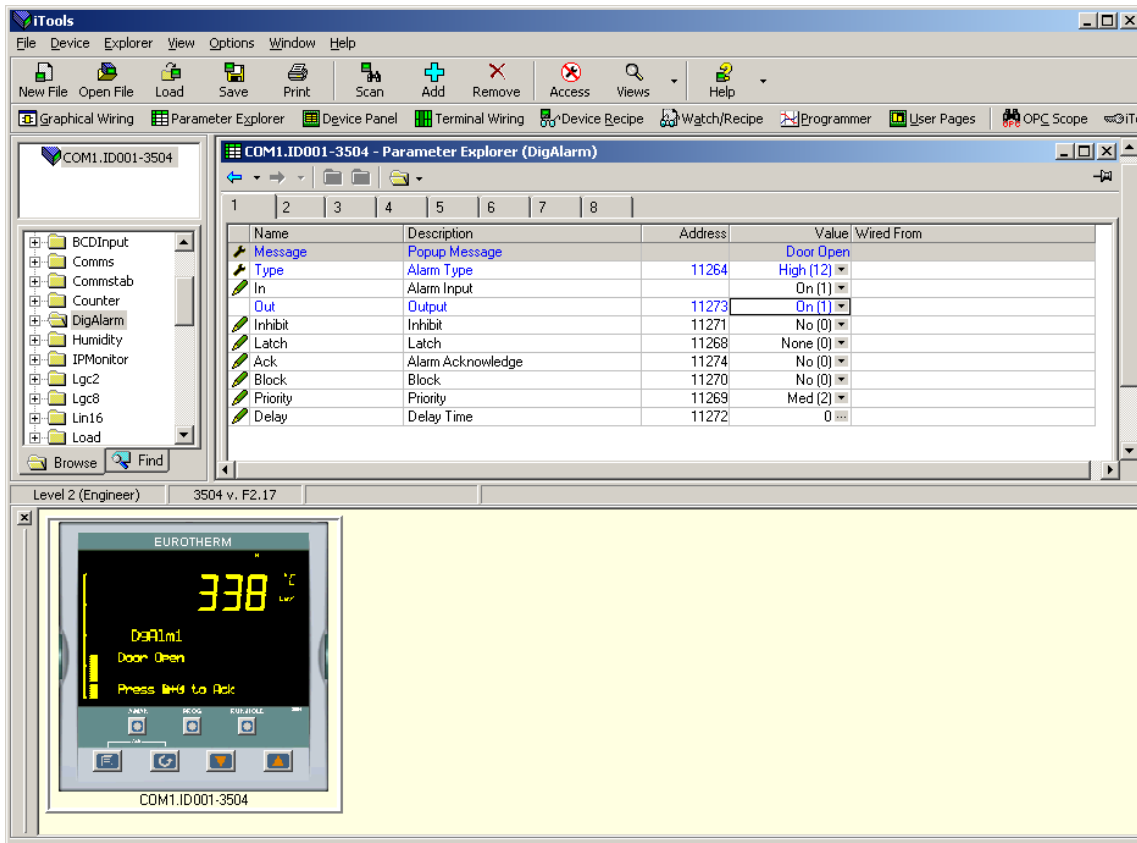

Figure 27-10: Alarm Summary Page

### 27.9.3 To Customise Digital Alarm Messages

In the 'DigAlarm' folder, enter the text which is to appear on the controller display when the digital event becomes true. In this example the message is 'Door Open'.



The simulation shows how the controller display will appear when the event is true.

Figure 27-12: To Configure Digital Alarms



### 27.10 Graphical Wiring Editor

Select **Graphical Wiring** (GWE) to view and edit instrument wiring. You can also add comments and monitor parameter values.

1. Drag and drop required function blocks into the graphical wiring from the list in the left pane
2. Click on parameter to be wired from and drag the wire to the parameter to be wired to (do not hold mouse button down)
3. Right click and choose Edit Parameter Value to change values
4. Select parameter lists and switch between parameter and wiring editors
5. Download to instrument when wiring completed
6. Add comments and notes
7. Dotted lines around a function block show that the function requires downloading

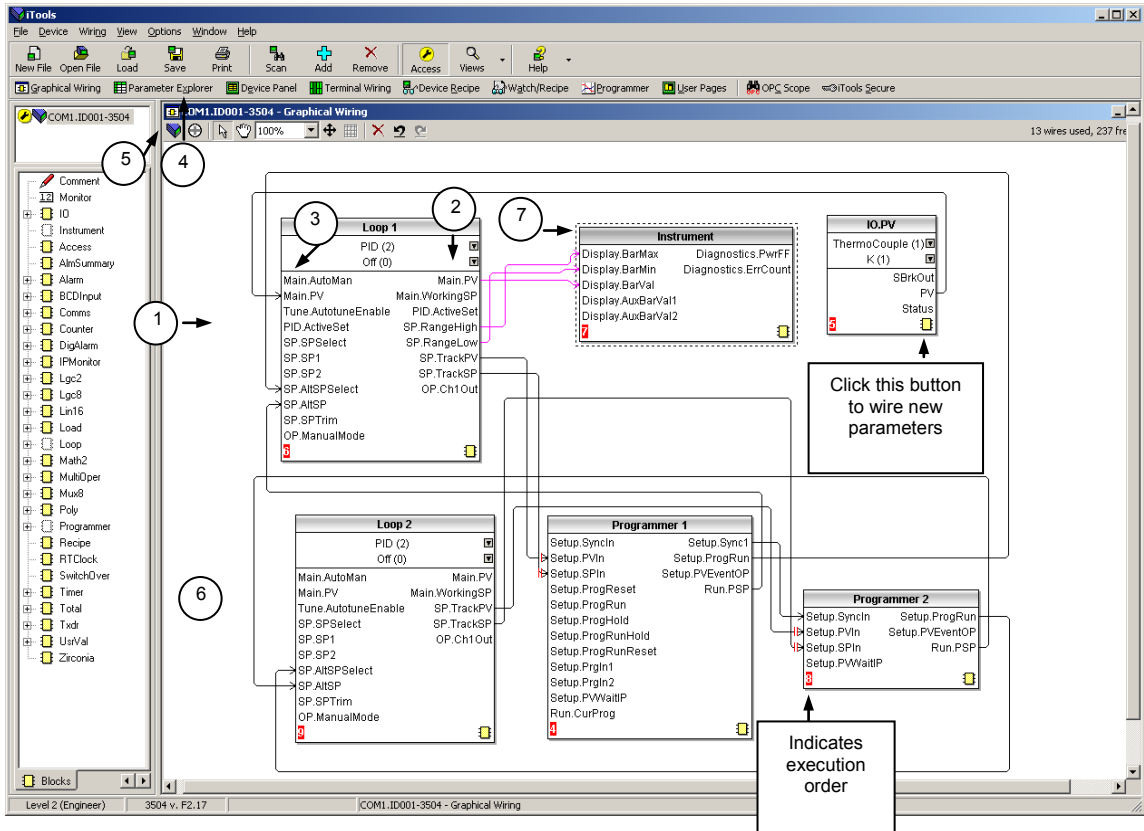

Figure 27-13: Graphical Wiring Editor for a Dual Programmer

#### 27.10.1 Graphical Wiring Toolbar

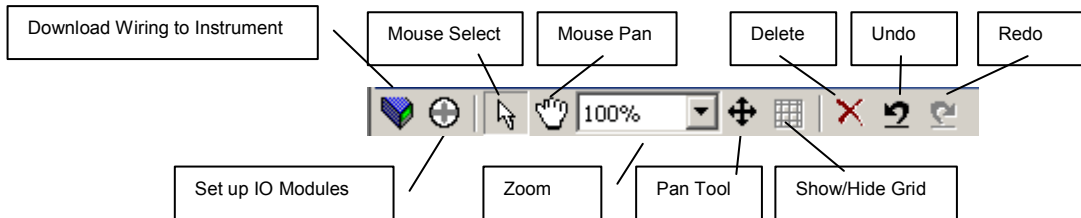

Figure 27-14: Detail of the Graphical Wiring Toolbar

**27.10.2 Terminology**

The following terms are used:-

**27.10.2.1 Function Block**

A Function Block is an algorithm which may be wired to and from other function blocks to make a control strategy. The Graphical Wiring Editor groups the instrument parameters into function blocks. Examples are: a control loop and a mathematical calculation.

Each function block has inputs and outputs. Any parameter may be wired from, but only parameters that are alterable may we wired to. A function block includes any parameters that are needed to configure or operate the algorithm.

**27.10.2.2 Wire**

A wire transfers a value from one parameter to another. They are executed by the instrument once per control cycle.

Wires are made from an output of a function block to an input of a function block. It is possible to create a wiring loop, in this case there will be a single execution cycle delay at some point in the loop. This point is shown on the diagram by a || symbol and it is possible to choose where that delay will occur.

**27.10.2.3 Block Execution Order**

The order in which the blocks are executed by the instrument depends on the way in which they are wired.

The order is automatically worked out so that the blocks execute on the most recent data.

**27.10.3 Using Function Blocks**

If a function block is not faded in the tree then it can be dragged onto the diagram. The block can be dragged around the diagram using the mouse.

A labelled loop block is shown here. The label at the top is the name of the block.

When the block type information is alterable click on the box with the arrow in it on the right to edit that value.

The inputs and outputs which are considered to be of most use are always shown. In most cases all of these will need to be wired up for the block to perform a useful task. There are exceptions to this and the loop is one of those exceptions.

If you wish to wire from a parameter which is not shown as a recommended output click on the icon in the bottom right and a full list of parameters in the block will be shown, click on one of these to start a wire.

To start a wire from a recommended output just click on it.

Click 'Select Output' to wire new parameters

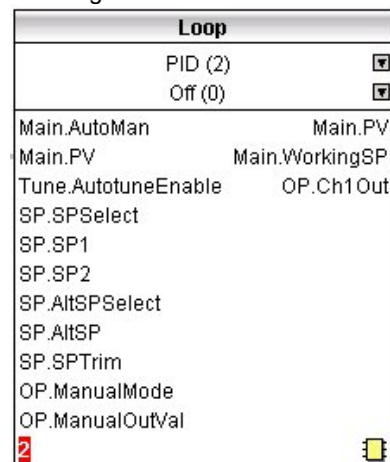
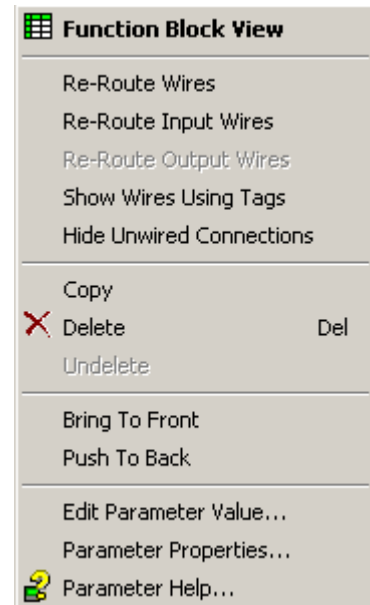

### 27.10.3.1 Function Block Context Menu

Right click in the function block to show a context menu which has the following entries:-

<b>Function Block View...</b>	Brings up an iTools parameter list which shows all the parameters in the function block. If the block has sub-lists these are shown in tabs
<b>Re-Route Wires</b>	Throw away current wire route and do an auto-route of all wires connected to this block
<b>Re-Route Input Wires</b>	Only do a re-route on the input wires
<b>Re-Route Output Wires</b>	Only do a re-route on the output wires
<b>Show Wires Using Tags</b>	Adds named tags to wires
<b>Hide Unwired Connections</b>	Displays only those parameters which are wired and hides all unwired connections
<b>Copy</b>	Right click over an input or output and copy will be enabled, this menu item will copy the iTools "url" of the parameter which can then be pasted into a watch window or OPC Scope
<b>Delete</b>	If the block is downloaded mark it for delete, otherwise delete it immediately
<b>Undelete</b>	This menu entry is enabled if the block is marked for delete and unmarks it and any wires connected to it for delete
<b>Bring To Front</b>	Bring the block to the front of the diagram. Moving a block will also bring it to the front
<b>Push To Back</b>	Push the block to the back of the diagram. Useful if there is something underneath it
<b>Edit Parameter Value</b>	This menu entry is enabled when the mouse is over an input or output parameter. When selected it creates a parameter edit dialog so the value of that parameter can be changed
<b>Parameter Properties</b>	Selecting this entry brings up the parameter properties window. The parameter properties window is updated as the mouse is moved over the parameters shown on the function block
<b>Parameter Help</b>	Selecting this entry brings up the help window. The help window is updated as the mouse is moved over the parameters shown on the function block. When the mouse is not over a parameter name the help for the block is shown

### 27.10.4 Tooltips

Hovering over different parts of the block will bring up tooltips describing the part of the block beneath the mouse.

If you hover over the parameter values in the block type information a tooltip showing the parameter description, it's OPC name, and, if downloaded, it's value will be shown.

A similar tooltip will be shown when hovering over inputs and outputs.

**27.10.5 Series 3000 Instruments**

The blocks in a series 3000 instrument are enabled by dragging the block onto the diagram, wiring it up, and downloading it to the instrument

When the block is initially dropped onto the diagram it is drawn with dashed lines.

When in this state the parameter list for the block is enabled but the block itself is not executed by the instrument.

Once the download button is pressed the block is added to the instrument function block execution list and it is drawn with solid lines.

If a block which has been downloaded is deleted, it is shown on the diagram in a ghosted form until the download button is pressed.

This is because it and any wires to/from it are still being executed in the instrument. On download it will be removed from the instrument execution list and the diagram.

A ghosted block can be undeleted using the context menu.

When a dashed block is deleted it is removed immediately.

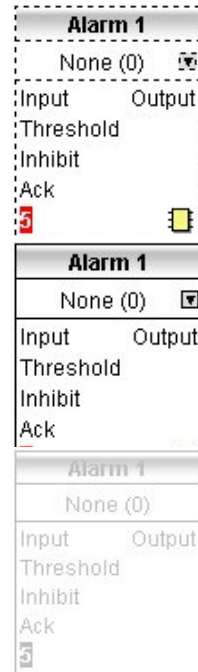

## 27.10.6 Using Wires

### 27.10.6.1 Making A Wire Between Two Blocks

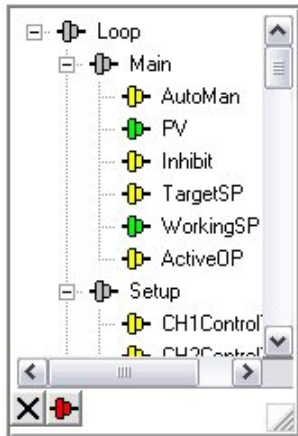

- Drag two blocks onto the diagram from the function block tree.
- Start a wire by either clicking on a recommended output or clicking on the icon at the bottom right corner of the block to bring up the connection dialog. The connection dialog shows all the connectable parameters for the block, if the block has sub-lists the parameters are shown in a tree. If you wish to wire a parameter which is not currently available click the red button at the bottom of the connection dialog. Recommended connections are shown with a green plug, other parameters which are available are yellow and if you click the red button the unavailable parameters are shown red. To dismiss the connection dialog either, press the escape key on the keyboard, or click the cross at the bottom left of the dialog.
- Once the wire has started the cursor will change and a dotted wire will be drawn from the output to the current mouse position.
- To make the wire either click on a recommended input to make a wire to that parameter or click anywhere except on a recommended input to bring up the connection dialog. Choose from the connection dialog as described above.
- The wire will now be auto-routed between the blocks.  
New wires on series 3000 instruments are shown dotted until they are downloaded

### 27.10.6.2 Wire Context Menu

Right click on the wire to show the wire block context menu which has the following entries:-

<b>Force Exec Break</b>	If wires form a loop a break point has to be found where the value which is written to the block input comes from a block which was last executed during the previous instrument execute cycle thus introducing a delay. This option tells the instrument that if it needs to make a break it should be on this wire
<b>Re-Route Wire</b>	Throw away wire route and generate an automatic route from scratch
<b>Use Tags</b>	If a wire is between blocks which are a long way apart, then rather than drawing the wire, the name of the wired to/from parameter can be shown in a tag next to the block. This menu entry toggles this wire between drawing the whole wire and drawing it as tags
<b>Find Start</b>	Finds the start of the wire
<b>Find End</b>	Finds the end of the wire
<b>Delete</b>	For series 3000 instruments if the wire is downloaded mark it for delete, otherwise delete it immediately
<b>Undelete</b>	This menu entry is enabled if the wire is marked for delete and unmarks it for delete
<b>Bring To Front</b>	Bring the wire to the front of the diagram. Moving a wire will also bring it to the front
<b>Push To Back</b>	Push the wire to the back of the diagram

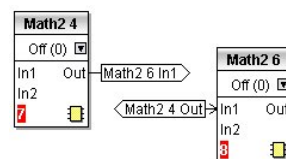
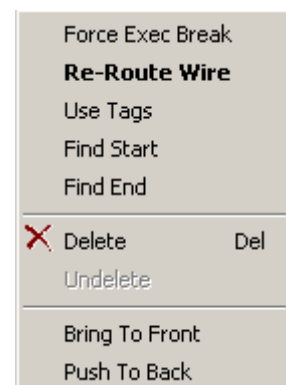

**27.10.6.3 Wire Colours**

Wires can be the following colours:

Black	Normal functioning wire.
Red	The wire is connected to an input which is not alterable when the instrument is in operator mode and so values which travel along that wire will be rejected by the receiving block
Blue	The mouse is hovering over the wire, or the block to which it is connected it selected. Useful for tracing densely packed wires
Purple	The mouse is hovering over a 'red' wire

**27.10.6.4 Routing Wires**

When a wire is placed it is auto-routed. The auto routing algorithm searches for a clear path between the two blocks. A wire can be auto-routed again using the context menus or by double clicking the wire.

If you click on a wire segment you can drag it to manually route it. Once this is done it is marked as a manually routed wire and will retain its current shape. If you move the block to which it is connected the end of the wire will be moved but as much of the path as possible of the wire will be preserved.

If a wire is selected by clicking on it, it will be drawn with small boxes on its corners.

**27.10.6.5 Tooltips**

Hover the mouse over a wire and a tooltip showing the names of the parameters which are wired and, if downloaded, their current values will also be shown.

**27.10.7 Using Comments**

Drag a comment onto the diagram and the comment edit dialog will appear.

Type in a comment. Use newlines to control the width of the comment, it is shown on the diagram as typed into the dialog. Click OK and the comment text will appear on the diagram. There are no restrictions on the size of a comment. Comments are saved to the instrument along with the diagram layout information.

Comments can be linked to function blocks and wires. Hover the mouse over the bottom right of the comment and a chain icon will appear, click on that icon and then on a block or a wire. A dotted wire will be drawn to the top of the block or the selected wire segment.

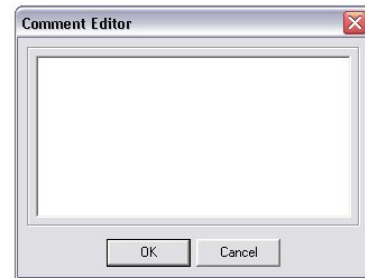

**27.10.7.1 Comment Context Menu**

The comment context menu has the following entries on it.

Edit	Open the comment edit dialog to edit this comment
Unlink	If the comment is linked to a block or wire this will unlink it
Delete	For series 3000 instruments if the comment is downloaded mark it for delete, otherwise delete it immediately
Undelete	This menu entry is enabled if the comment is marked for delete and unmarks it for delete
Bring To Front	Bring the comment to the front of the diagram. Moving a comment will also bring it to the front
Push To Back	Push the comment to the back of the diagram. Useful if there is something underneath it

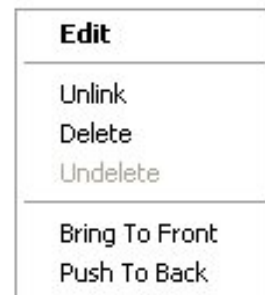

### 27.10.8 Using Monitors

Drag a monitor onto the diagram and connect it to a block input or output or a wire as described in 'Using Comments'.

The current value (updated at the iTools parameter list update rate) will be shown in the monitor. By default the name of the parameter is shown, double click or use the context menu to not show the parameter name.

#### 27.10.8.1 Monitor Context Menu

The monitor context menu has the following entries on it.

Show Names	Show parameter names as well as values
Unlink	If the monitor is linked to a block or wire this will unlink it
Delete	For series 3000 instruments if the monitor is downloaded mark it for delete, otherwise delete it immediately
Undelete	This menu entry is enabled if the monitor is marked for delete and unmarks it for delete
Bring To Front	Bring the monitor to the front of the diagram. Moving a monitor will also bring it to the front
Push To Back	Push the monitor to the back of the diagram. Useful if there is something underneath it

### 27.10.9 Downloading To Series 3000 Instruments

Series 3000 wires have to be downloaded to the instrument together. When the wiring editor is opened the current wiring and diagram layout is read from the instrument. No changes are made to the instrument function block execution or wiring until the download button is pressed. Any changes made using the instrument front panel after the editor is opened will be lost on download.

When a block is dropped on the diagram instrument parameters are changed to make the parameters for that block available. If changes are made and the editor is closed without saving them there will be a delay while the editor clears these parameters.

During download, the wiring is written to the instrument which then calculates the block execution order and starts executing the blocks. The diagram layout including comments and monitors is then written into instrument flash memory along with the current editor settings. When the editor is reopened, the diagram will be shown positioned the same as when it was last downloaded.

#### 27.10.10 Selections

Wires are shown with small blocks at their corners when selected. All other items have a dotted line drawn round them when they are selected.

##### 27.10.10.1 Selecting Individual Items

Clicking on an item on the drawing will select it.

##### 27.10.10.2 Multiple Selection

Control click an unselected item to add it to the selection, doing the same on a selected item unselects it.

Alternatively, hold the mouse down on the background and wipe it to create a rubber band, anything which isn't a wire inside the rubber band will be selected.

Selecting two function blocks also selects any wires which join them. This means that if more than one function block is selected, using the rubber band method, any wires between them will also be selected.

Pressing Ctrl-A selects all blocks and wires.

### 27.10.11 Colours

Items on the diagram are coloured as follows:

Red	Function blocks, comments and monitors which partially obscure or are partially obscured by other items are drawn red. If a large function block like the loop is covering a small one, like a math2, the loop will be drawn red to show that it is covering another function block. Wires are drawn red when they are connected to an input which is currently unalterable. Parameters in function blocks are coloured red if they are unalterable and the mouse pointer is over them
Blue	Function blocks, comments and monitors which are not coloured red are coloured blue when the mouse pointer is over them. Wires are coloured blue when a block to which the wire is connected is selected or the mouse pointer is over it. Parameters in function blocks are coloured blue if they are alterable and the mouse pointer is over them
Purple	A wire which is connected to an input which is currently unalterable and a block to which the wire is connected is selected or the mouse pointer is over it is coloured purple (red + blue)

### 27.11 Diagram Context Menu

Right click in the spaces around the wires and function blocks to show the diagram context menu which has the following entries:-

<b>Re-Route Wires</b>	Throw away current wire route and do an auto-route of all selected wires. If no wires are selected this is done to all wires on the diagram
<b>Align Tops</b>	Line up the tops of all the selected items except wires
<b>Align Lefts</b>	Line up the left hand side of all the selected items except wires
<b>Space Evenly</b>	This will space the selected items such that their top left corners are evenly spaced. Select the first item, then select the rest by control-clicking them in the order you wish them to be spaced, then choose this menu entry
<b>Delete</b>	Delete, or mark for delete (series 3000 instruments) all selected items
<b>Undelete</b>	This menu entry is enabled if any of the selected items are marked for delete and unmarks them when selected
<b>Select All</b>	Select all wires
<b>Copy Graphic</b>	If there is a selection it is copied to the clipboard as a Windows metafile, if there is no selection the whole diagram is copied to the clipboard as a Windows metafile. Paste into your favourite documentation tool to document your application. Some programs render metafiles better than others, the diagram may look messy on screen but it should print well
<b>Save Graphic</b>	Same as Copy Graphic but saves to a metafile rather than putting it on the clipboard
<b>Centre</b>	Select all wires then Centre. The graphical view will be centred in the iTools window.

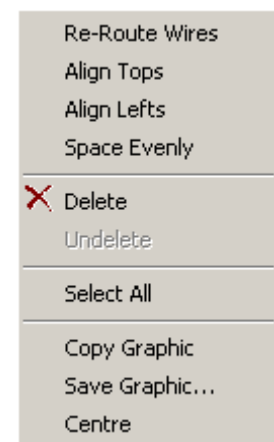



### 27.11.1 Other Examples of Graphical Wiring

#### Simulated Load

This may be useful as a test to show the action of a closed loop PID controller.

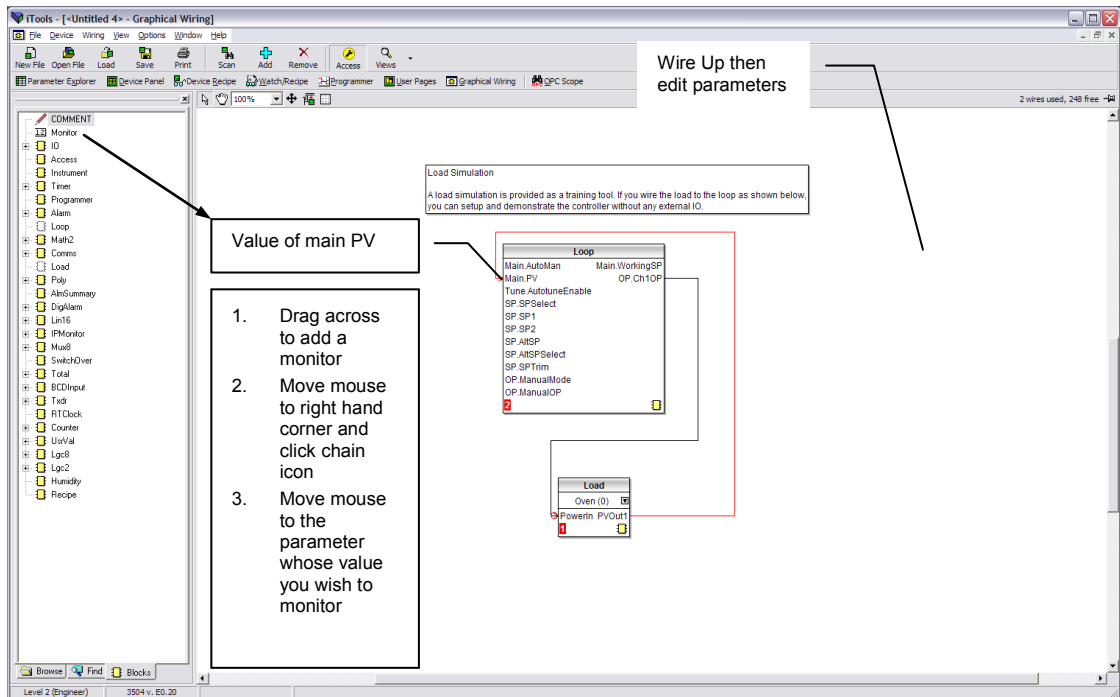

#### Loop/Programmer Wiring

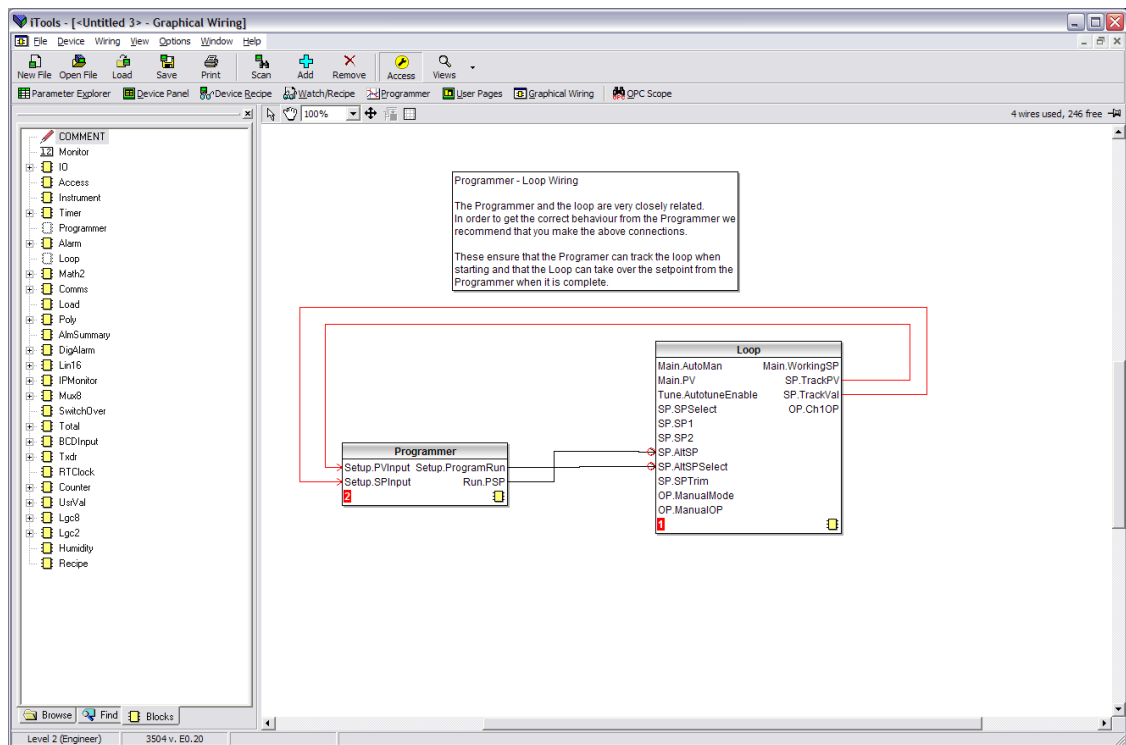

**Note:** The wires on this diagram are auto generated if the loop and programmer are enabled and there are no wires connected to the four inputs.

### Bargraph

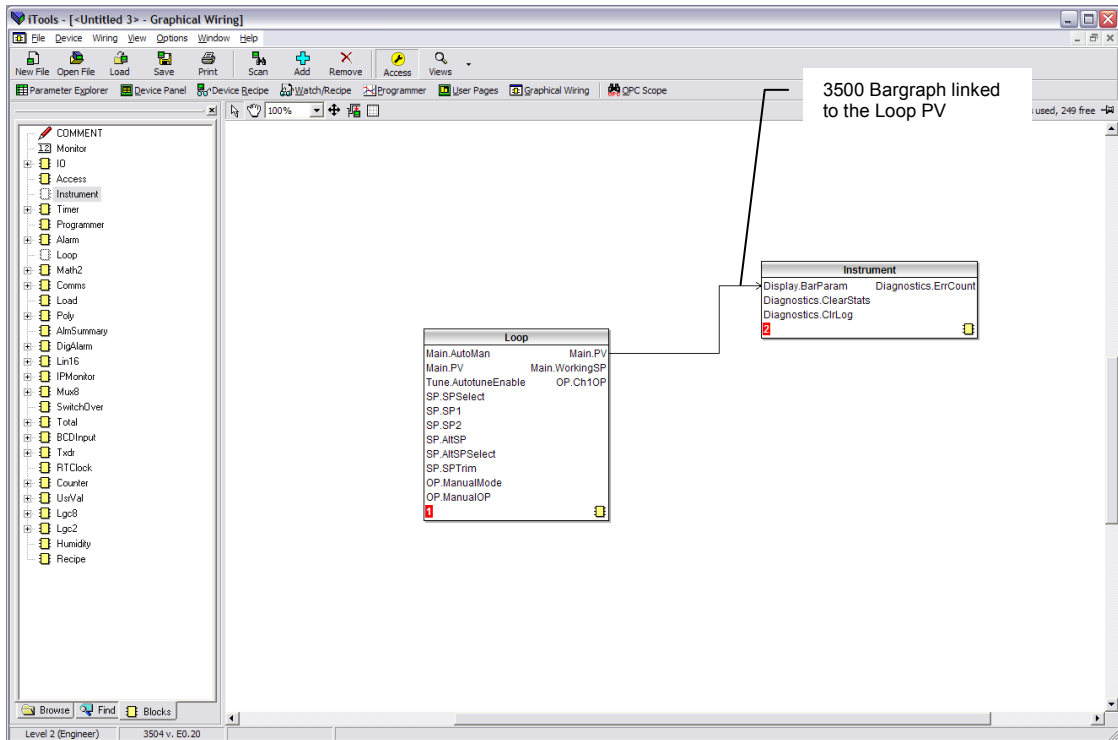

### Bargraph with Alarm Values Displayed

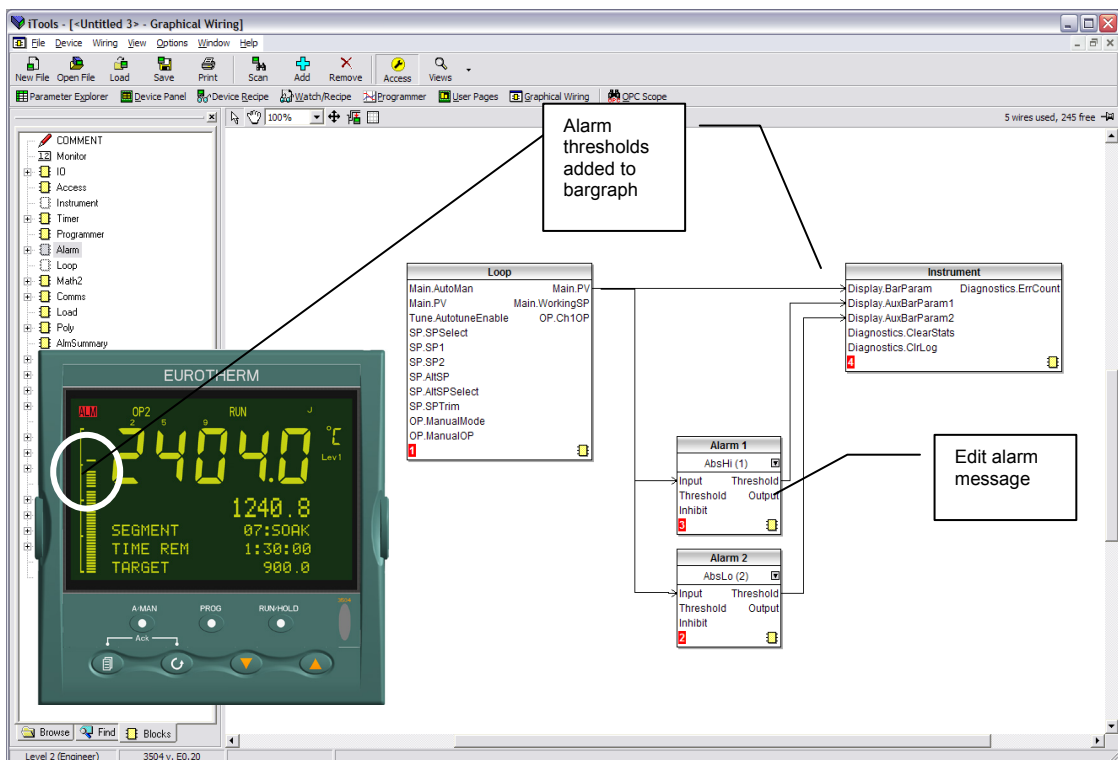

### Retransmission of Channel 1 Output Value

The most common requirement is to retransmit parameters such as PV, SP, Output 1 or 2 or Error. In 3500 controllers, however, it is possible to re-transmit any wireable parameter. The example below shows how to do this.

Select Graphical Wiring. The view below shows a simple single channel controller with alarms. The output is wired to the LA logic output for control purposes.

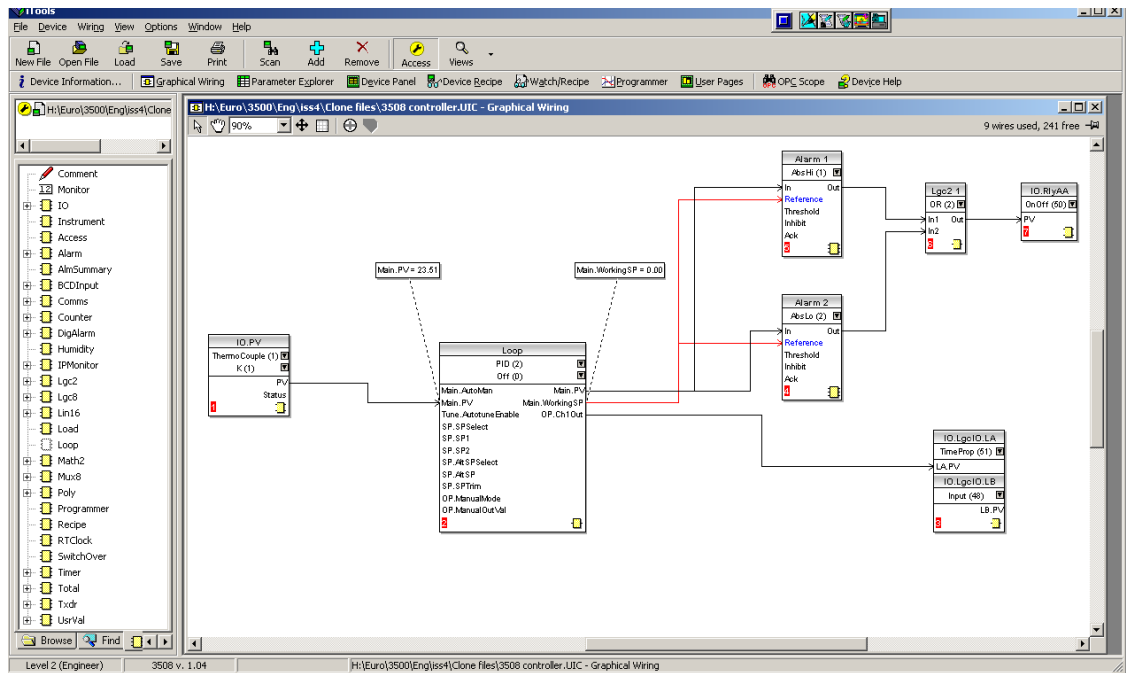

1. Drag and drop IO.Mod1Ds block from the IO list. Choose a module (e.g. 1) and select DC Retran.
2. Click on the parameter to be retransmitted (in this case OP.Ch1Out). Drag a wire (do not hold the mouse button down) to  in the bottom right hand corner of IO.Mod1Ds block
3. Select Mod1Ident in the pop up window.
4. The procedure may be repeated if it required to retransmit other parameters via other modules.

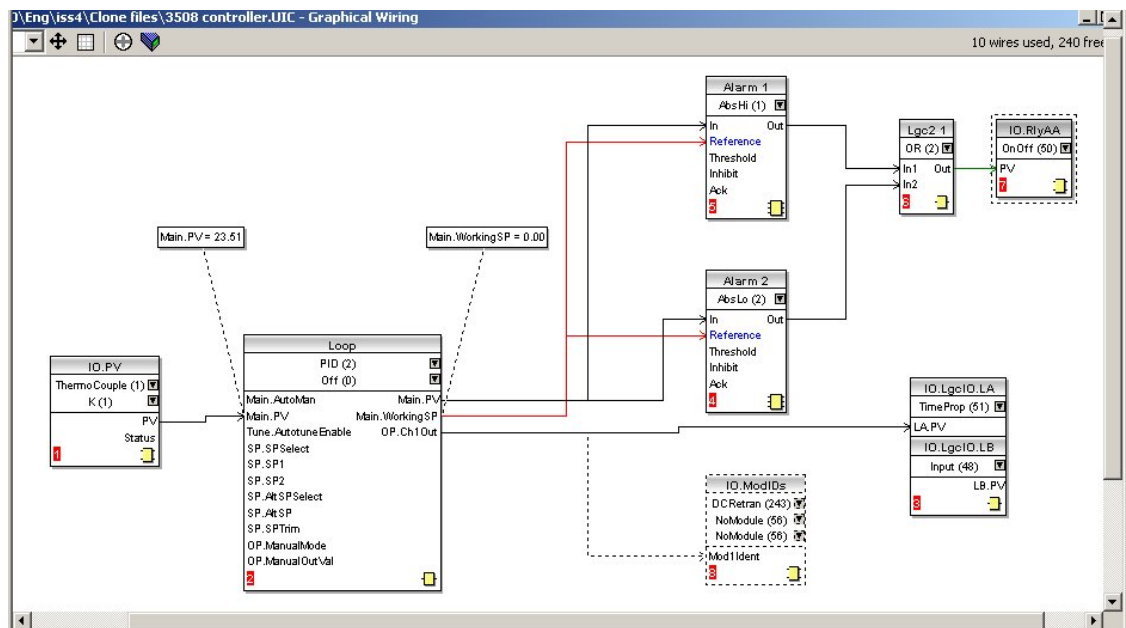

When saved the dotted lines become solid

## 27.12 Program Editor

ITools provides a convenient method of entering and editing programs directly in the controller. Setpoint programs can be created graphically, stored and downloaded into the controller.

### 27.12.1 Analog View

1. Press Programmer to edit a program. For a dual programmer shown below select the Segment Parameters tab. The other tabs display program parameters for each program.
2. Select a program number using Program: 1
3. Click Program Name and enter a name for the program
4. Press in the Programmer Editor to add a segment
5. Select 'SegType' from the drop down and enter the segment details. The event outputs are displayed using dots in the EventOuts row. Hold the mouse pointer over the EventOuts cell and a tooltip pops up showing the number, name and value of each of the events.
6. Enter a name for the Target SP if required
7. Repeat for all required segments
8. To insert a segment, click in the segment number where it is to be inserted, then press in the Programmer Editor. Alternatively right click in the segment to show a pop up.

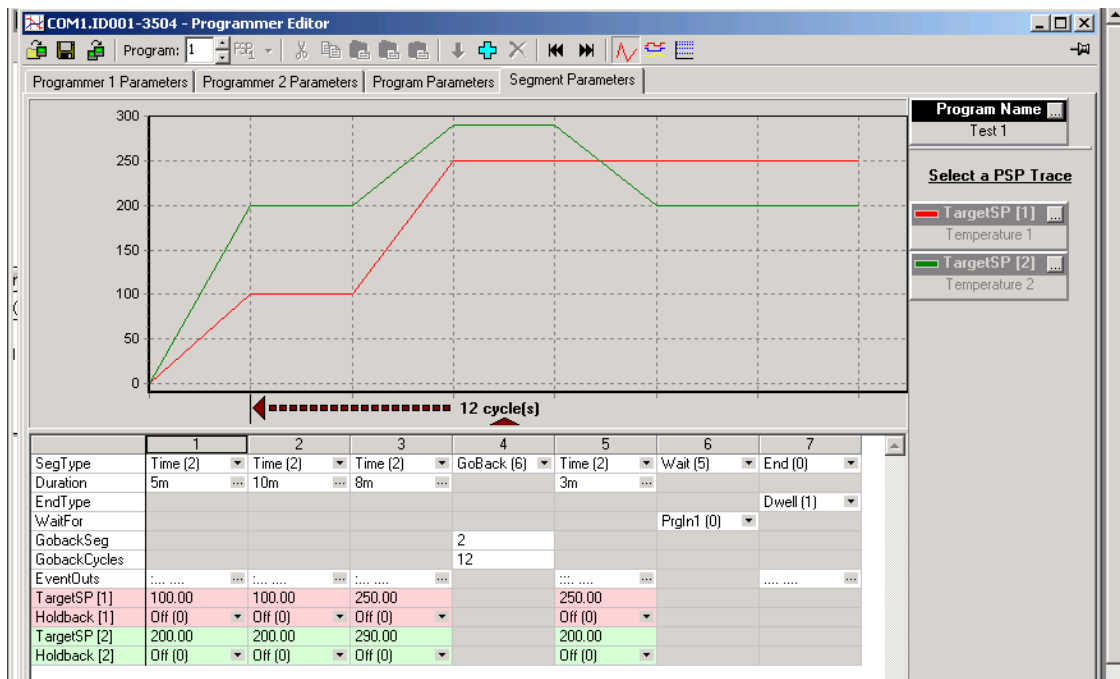

#### 27.12.1.1 Segment Types

Possible segment types are:-

Rate, Dwell, Step, Time, GoBack, Wait, Call and End, all of which are available in a Single Programmer. In a SyncAll programmer Rate, Dwell, Step are not available.

In a SyncStart programmer Call is not available.

### 27.12.2 The Spreadsheet

The segment values are shown in a spreadsheet format. Each cell either contains a set of enumerated values shown as a drop down list, a numerical value, or a duration.

To change an enumeration either type its numeric value or choose from the drop down list. If the enumeration is for an event output and so only has the values 'On (1)' and 'Off (0)' you can double click the cell to change to the other value.

To change a numeric value, click on the cell and type the new value. It is accepted when you move on to another cell using the 'enter', tab or arrow keys.

To change a duration type it in the format '\_h \_m \_s \_ms' where \_ is a number. You can leave bits out but if they appear they must be in the order shown. E.g., '1m 30s' is acceptable but '30s 1m' is not.

☺ If you select and copy spreadsheet cells they are put on the clipboard as tab separated values which can be pasted into Microsoft Excel.

### 27.12.3 Event Outputs

These may be set in the previous Analog View by clicking the ellipsis in the relevant segment, then ticking the required digital output in the pop up view. Alternatively use 'Digital View' as follows:-

1. Press  to select the digital events view.
2. Right click in the blank area to 'Add Segment'
3. Use the pull downs to turn the digital event On or Off in the selected segment

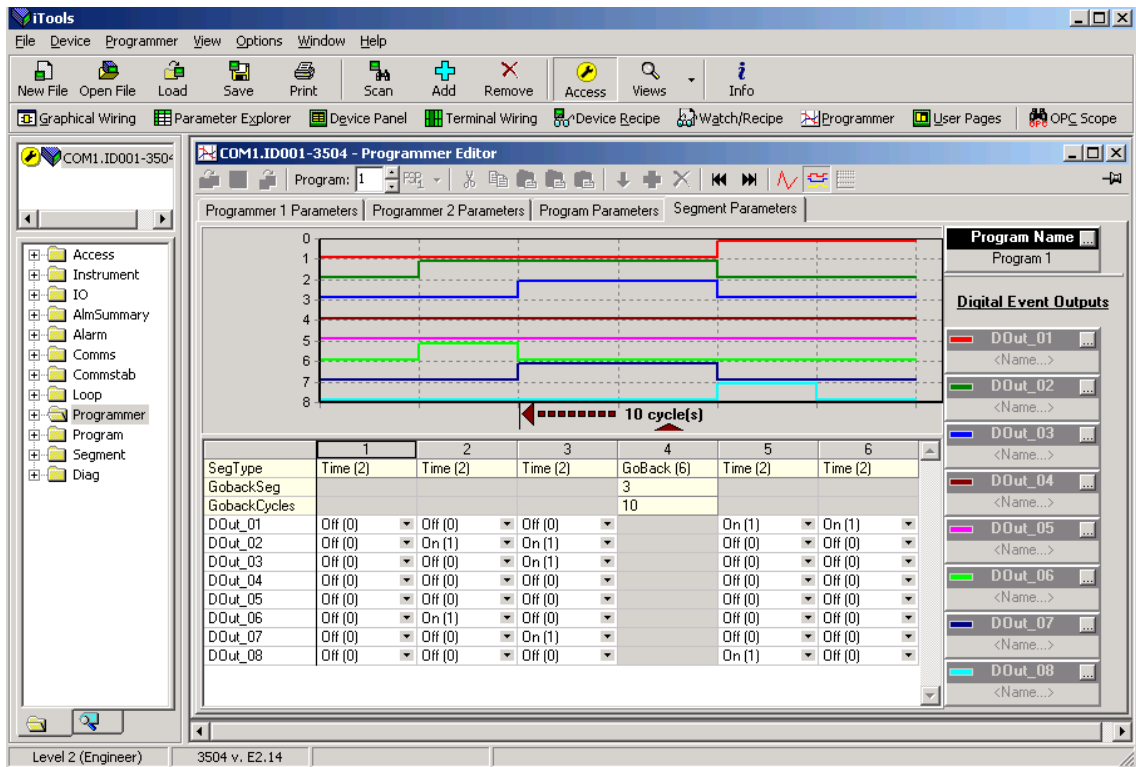

	1	2	3	4	5	6
SegType	Time (2)	Time (2)	Time (2)	GoBack (6)	Time (2)	Time (2)
GobackSeg				3		
GobackCycles				10		
DOut_01	Off (0)	Off (0)	Off (0)		On (1)	On (1)
DOut_02	Off (0)	On (1)	On (1)		Off (0)	Off (0)
DOut_03	Off (0)	Off (0)	On (1)		Off (0)	Off (0)
DOut_04	Off (0)	Off (0)	Off (0)		Off (0)	Off (0)
DOut_05	Off (0)	Off (0)	Off (0)		Off (0)	Off (0)
DOut_06	Off (0)	On (1)	Off (0)		Off (0)	Off (0)
DOut_07	Off (0)	Off (0)	On (1)		Off (0)	Off (0)
DOut_08	Off (0)	Off (0)	Off (0)		On (1)	Off (0)

### 27.12.4 Menu Entries and Tool Buttons

Most of the menu entries documented above have an associated tool button that performs the same action. Hold the mouse over each button to find out what it does.

### 27.12.5 The Context Menu

There is a context menu on the spreadsheet that has 'Select All', 'Copy', 'Paste Insert', 'Paste Over', 'Insert' and 'Delete' entries. These perform the same actions as those in the Edit menu.

### 27.12.6 Naming Programs

The programs can be given names. These names are saved in the program file and as comments in any clone file made from the instrument. The program name is also written to the instrument. To enter a name, either double click the trace label or click the small grey button on it. You can enter up to 16 characters as the name.

### 27.12.7 Entering a Program

You can connect to a device or load a clone file as you normally would and then select the programmer view using the view button on the toolbar or the context menu for the device.

To create a new program, create a new clone file and start the programmer editor using that clone.



**Note:** if you need to be able to put the device/simulation into configuration mode this can only be done within iTools.

### 27.12.8 Making Changes to a Program

There are three tabs along the bottom of the editor, the last one shows the segment data in a graph and a grid. The others show standard iTools lists which are used to set up programmer related parameters for the whole instrument and for the current program. You will only see the parameters that set up instrument wide program parameters if the instrument is in configuration mode.

The 'Segment Parameters' tab is the default and the one where the program itself is edited. To change a numeric value click in the tab, type the new number and enter. To change an enumerated value click on the down arrow button and choose the new value. The segment values are edited 'in place' whereas the iTools parameter lists popup a dialog to change the value.

If you are connected to a device the changes will be written to it immediately. If you created a new program or opened a saved program you will have to save the changes to a file.

### 27.12.9 Saving Programs

The stand alone editor has a 'File|Save' menu entry which is used to write the program out to a file. Each program is saved in a separate file. If you wish to clone all of the programs from one instrument to another you will have to use the iTools cloning facilities to do this.

When using the editor within iTools, there is an entry on the Programmer menu for saving programs.

### 27.12.10 Moving Programs Around

The 'File|Send To' menu entry can be used to copy a program to a connected instrument. A dialog pops up in which you have to select the instrument and the destination program number. You can use this to copy programs within the same instrument or to open a program file and download it.

### 27.12.11 Printing a Program

There is no direct printing support in the Programmer Editor, but you can generate a report using Microsoft Excel as follows:

- Right click on the graph and choose 'Copy Chart'.
- Open a new spreadsheet in Excel and paste the chart, position to taste.
- Go back to the Programmer Editor and Choose 'Edit|Select All' followed by 'Edit|Copy'.
- Switch to Excel, choose the top left cell for the segment data and then choose 'Edit|Paste'.
- Optionally delete any columns that have no settings and format the cells.
- Print the spreadsheet.

The program is listed down rather than across the page so long programs can be printed.

### 27.12.12 To Copy a Program

- In the display shown above, to copy the complete program, right click in the spreadsheet section and 'Select All'.
- Right click again in the spreadsheet section and 'Copy'.
- Select the program number to be copied to, e.g. Program 2.
- Right click in the new section and 'Paste All'.

### 27.12.13 To Copy a Segment of a Program

- Right click in the segment to be copied and select 'Copy'.
- To add the segment at the end of the program, right click outside the segments and 'Paste Add'
- To insert, right click in the preceding segment and 'Paste Insert'
- To over-write a segment, right click in the segment and 'Paste Over'

Segments will be added to the Event Outputs at the same time.

### 27.12.14 To Name a User Value

The programmer User Value may be given a name.

- Open the parameter list for the Programmer Setup page
- Select UVValName and type in the required text. In this example 'Power'
- 'User Value' in the Program Edit page in the controller will be replaced by this text

The screenshot shows the iTools software interface. The main window is titled 'COM1.ID001-3504 - Parameter Explorer (Programmer.1.Setup)'. It displays a table of parameters with columns for Name, Description, Address, Value, and Wired From. The 'UVValName' parameter is highlighted, and its value is set to 'Power'. The 'Wired From' column for 'UVValName' is empty.

Name	Description	Address	Value	Wired From
EnableUserVal	Enable Programmer User Value		Yes (1) ▾	
UVValName	User Value Name		Power	
EnableGSoak	Enable Guaranteed Soak		No (0) ▾	
EnableDelayedStart	Enable Delayed Start		No (0) ▾	
EnablePIDScheduled	Enable Programmer PID Set		No (0) ▾	
EnableImmPSP	Enable Immediate PSP		No (0) ▾	
SyncMode	Synchronisation Mode	5191	No (0) ▾	
ProgReset	Program Reset	5225	Yes (1) ▾	
ProgRun	Program Run	5226	No (0) ▾	
ProgHold	Program Hold	5227	No (0) ▾	
ProgRunHold	Program Run Hold Input	5228	No (0) ▾	
ProgRunReset	Program Run Reset Input	5229	No (0) ▾	
AdvSeg	Advance Segment	5209	No (0) ▾	
Slave1Instance	Not Used			1
SkipSeg	Skip Segment	5210	No (0) ▾	
PrgIn1	Programmer Digital Input 1	5218	Off (0) ▾	
PrgIn2	Programmer Digital Input 2	5219	Off (0) ▾	
PVWaitIP	PV Wait Input	5220	0.00	
EventOut1	Event Output 1		Off (0) ▾	
EventOut2	Event Output 2		Off (0) ▾	
EventOut3	Event Output 3		Off (0) ▾	
EventOut4	Event Output 4		Off (0) ▾	
EventOut5	Event Output 5		Off (0) ▾	
EventOut6	Event Output 6		Off (0) ▾	
EventOut7	Event Output 7		Off (0) ▾	
EventOut8	Event Output 8		Off (0) ▾	
EndOfSeg	End of Segment	5206	Off (0) ▾	
ProgError	Program Error	5221	NoError (0) ▾	
PVEventOP	PV Event Output	5222	Off (0) ▾	
UVValName	User Value Name			

The status bar at the bottom of the window shows 'Level 2 (Engineer)', '3504 v. F2.17', and 'EnablePIDScheduled - Enable Programmer PID Set'.

## 27.13 Cloning

The cloning feature allows the configuration and parameter settings of one instrument to be copied into another. Alternatively a configuration may be saved to file and this used to download to connected instruments. The feature allows new instruments to be rapidly set up using a known reference source or standard instrument. Every parameter and parameter value is downloaded to the new instrument which means that if the new instrument is used as a replacement it will contain exactly the same information as the original. Cloning is generally only possible if the following applies:

- The target instrument has the same hardware configuration as the source instrument
- The target instrument firmware (i.e. Software built into the instrument) is the same as or a later version than that of the source instrument. The instrument firmware version is displayed on the instrument when power is applied.



**Warning: It is the responsibility of the user to ensure that the information cloned from one instrument to another is correct for the process to be controlled, and that all parameters are correctly replicated into the target instrument.**

Below is a brief description of how to use this feature. Further details are available in the iTools Handbook.

### 27.13.1 Save to File

The configuration of the controller made in the previous sections may be saved as a clone file. This file can then be used to download the configuration to further instruments.

From the File menu use 'Save to File' or use the 'Save' button on the Toolbar.

#### 27.13.1.1 Loading a Clone File Using the IR & Config Clips

When iTools is communicating with the instrument via the IR or Config Clips and a clone file is loaded, ALL parameters are cloned, including communications parameters.

This is possible as the actual communications mechanism will not be altered by changing these parameters. The communication mechanism will be fixed within the instrument by the use of these clips, see above.

### 27.13.2 To Clone a New Controller

Connect the new controller to iTools and Scan to find this instrument as described at the beginning of this chapter.

From the File menu select 'Load Values From File' or select 'Load' from the toolbar. Choose the required file and follow the instruction. The new instrument will be configured to this file.

### 27.13.3 To Clone Directly from One Controller to Another

Connect the second controller to iTools and scan for the new instrument

From the File menu select 'Send to Device'. Select the controller to be cloned and follow the instructions. The old instrument will be configured the same as the new one.



### 27.14 Clone of Comms Port Settings

Assuming that the PC is connected to the H port on the controller then the settings on this port are not cloned since this would then prevent communications to the controller and hence prevent cloning of other parameters. However, the J port settings will be cloned.

Similarly, if the PC is connected to the J port of the controller, then the H port setting will be cloned but not J.

If the PC is connected through the IR port or via the RJ45 clip then both H and J port settings will be cloned.

### 27.15 User Text

User defined text can be applied to selected parameters in controllers from software versions 2.30+.

User text is particularly useful when used in conjunction with User Pages, section 27.7. It is configured using iTools configuration package – it cannot be configured through the controller user interface, and is implemented in two ways:-

1. A fixed set of boolean parameters, shown in the table below, have dedicated user strings. The 'Value' of these parameters may be customised and it will then be shown as such in the enumeration of that parameter.

Function block	Default Text	Dedicated User String	iTools Browser
Two Input Logic Operators, see logic operators section 18.1.	Off On	OutUsrTxtOff OutUsrTxtOn	Lgc2 (1 to 24)
Eight Input Logic Operators, see logic operators section 18.1.1.	Off On	OutUsrTxtOff OutUsrTxtOn	Lgc8 (1 to 2)
Programmer Event Outputs 1 to 8, see programmer section 22.4.	Off On	EO1UsrTxtOff to EO8UsrTxtOff EO1UsrTxtOn to EO8UsrTxtOn	Programmer (1 to 2)
Programmer PV Event Outputs 1 to 8, see programmer section 22.4.1.	Off On	PVEOUsrTxtOff PVEOUsrTxtOfn	Programmer (1 to 2)

2. Eight user text blocks are available in which user defined text can be applied to both Boolean and Analogue parameters. Boolean parameters, not listed in 1 above, may be wired to Two Input Logic Operator blocks when user text blocks are in full use.

The parameter list for the User Text block is as follows:-

Parameter	Upper Limit	Lower Limit	Availability	Description
Input	32767	-32766	iTools configuration package, or read only in the controller display but can be wired through the controller	Input to be enumerated
Output	8 characters	-	iTools configuration package, or read only in the controller display but can be wired through the controller interface.	String from custom list with a value field that matches the current input
Custom list	100 characters		Comma separated list of values and strings	Configured by iTools

### 27.16 To Enable User Text

This may be done in configuration level, see section 6.3.1. It may also be done in iTools as described below. The controller must be placed in configuration level by pressing 

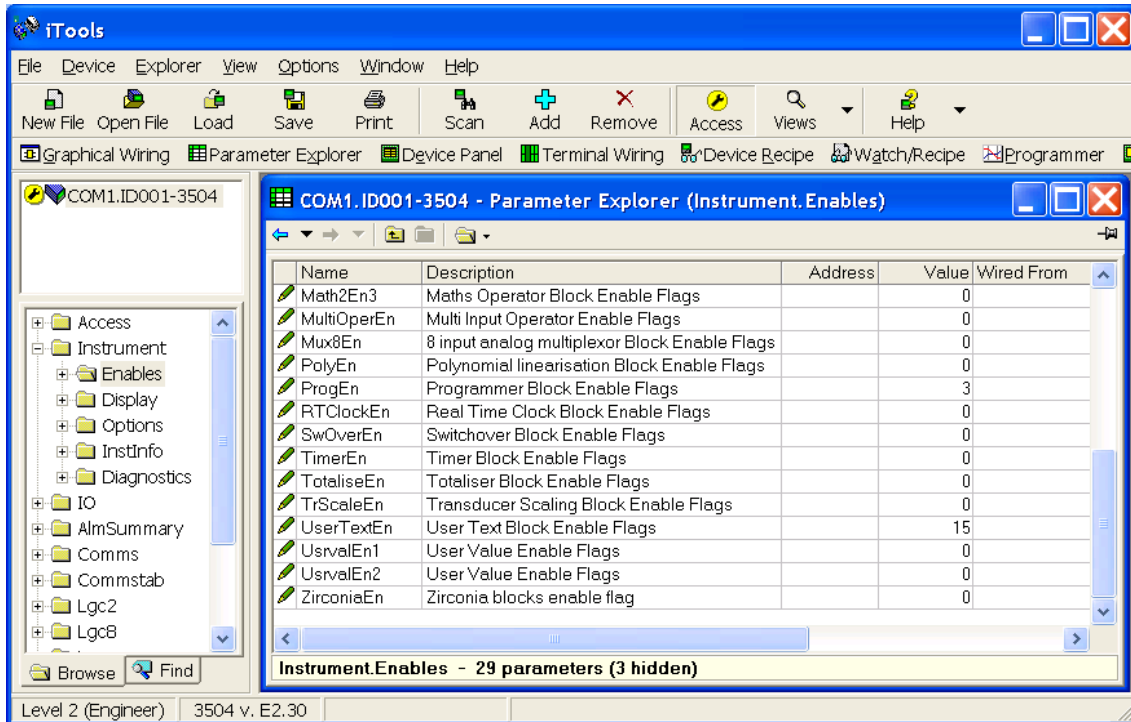

Select Instrument → Enables. Each user text block can be enabled by entering the decimal number corresponding to the bit map shown in the table. The table shows how to select any one of the first 4 blocks individually followed by all 4, 5, 6, 7 and 8 blocks.

Enable block number								Value
8	7	6	5	4	3	2	1	
0	0	0	0	0	0	0	0	0
0	0	0	0	0	0	0	1	1
0	0	0	0	0	0	1	0	2
0	0	0	0	0	0	1	1	3
0	0	0	0	0	1	0	0	4
0	0	0	0	0	1	0	1	5
0	0	0	0	0	1	1	0	6
0	0	0	0	0	1	1	1	7
0	0	0	0	1	0	0	0	8
0	0	0	0	1	1	1	1	15
0	0	0	1	1	1	1	1	31
0	0	1	1	1	1	1	1	63
0	1	1	1	1	1	1	1	127
1	1	1	1	1	1	1	1	255

## 27.17 Loop Naming

An additional parameter 'LoopName' has been added to the Loop Setup page for use controllers fitted with software versions 2.30+. This parameter is only available in iTools and will allow names to be given to each loop. The name will show on the loop summary pages only (it is not shown in the dual loop summary page since there is insufficient space for meaningful text).

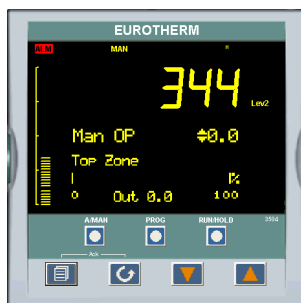
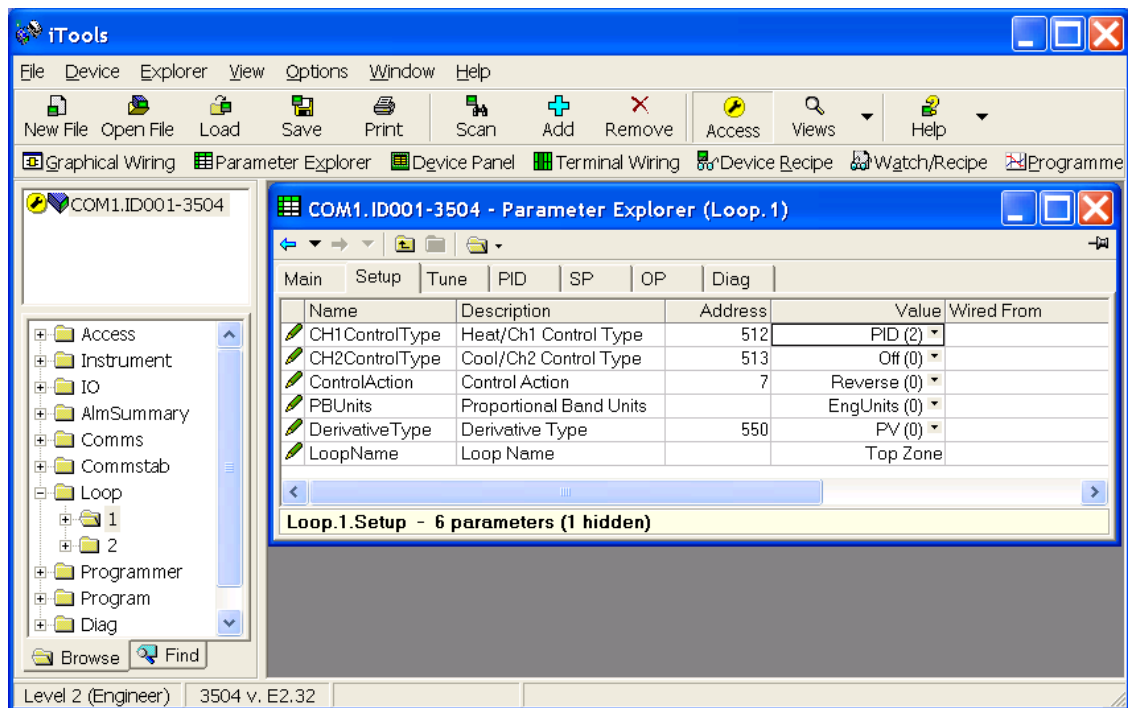

In this example the name 'Top Zone' will be applied to loop 1.

The numbers of characters is limited to 11 for both 3504 and 3508 (although truncated to 10 for the 3508).

☺ Custom loop names are over written when the loop is being auto-tuned by the default text 'Loop 1/Loop 2'.

## 27.18 Example 1: To Configure Lgc2 Operator 1

In this example when either input 1 or 2 is true (OR) the output text will read 'Open'. When neither input is true it will read 'Closed'

1. Select Lg2 → 1
2. Select either OutUsrTxtOff or OutUsrTxtOn and enter the required text in the 'Value' column

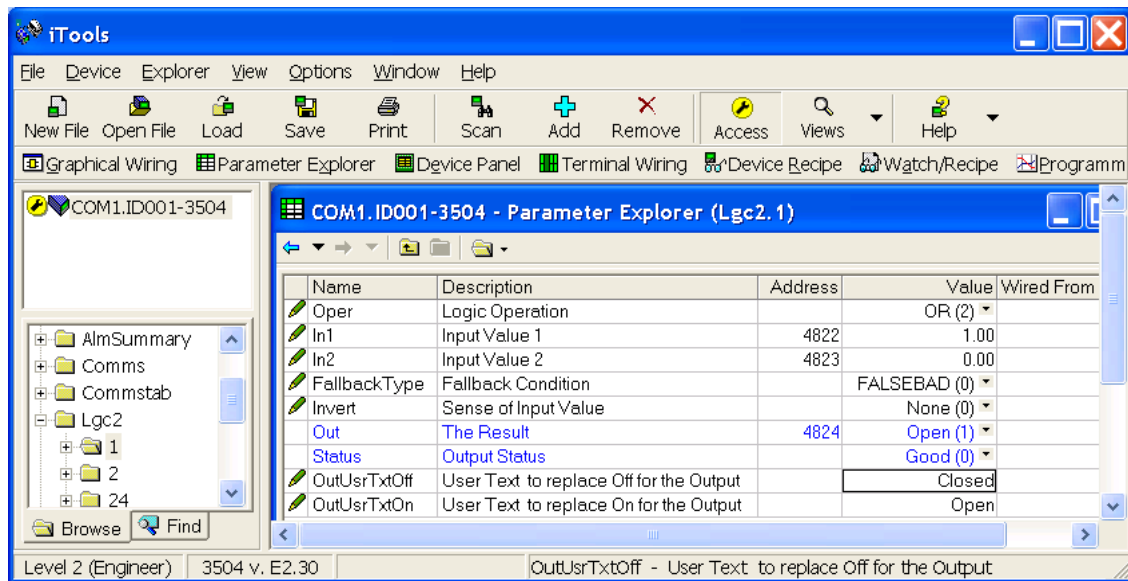

### 27.18.1 Example 2: Configure User Text Block 1

In this example the output user text will show 'Large' or 'Small' depending on the state of a digital input (in this case the LA input). It can also be used to read 'TwoUnits', '999Units' or '-1Units' depending on the value of an analogue input i.e. 2, 999 or -1 respectively.

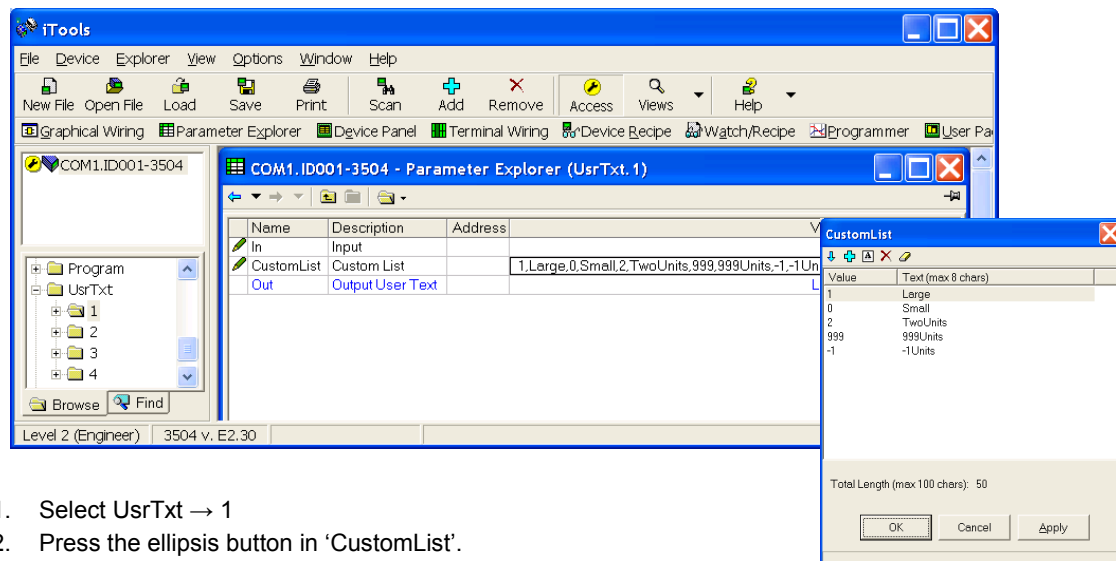

1. Select UsrTxt → 1
2. Press the ellipsis button in 'CustomList'.
3. A pop up window is shown

In the pop up, enter a value. 1 and 0 are used for Booleans or Analogue values. Any analogue value can be entered between 32767 and -32766. Enter text against the chosen value. In this example when the input is true 'Large' will be displayed. When false, 'Small' is displayed.

The user text can also be wired to a source parameter. In the above example the 'UsrTxt1 Input' is wired to the LA logic input. When the logic input is true (1) the user text will display 'Large'. When it is false (0) it will call up 'Small'.

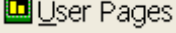
These values may be promoted to a user page. Select  in iTools. Use the 'Style' Value only, Split Row, Single Row, Dual Row or Triple Row.

## 27.19 To Name a User Switch

The User Switch function block has been added to 3500 series controllers from software version 2.70. Refer to chapter 29 for further information.

By default the controller will display On or Off when the User Switch is operated. A customised name up to eight characters may be applied the switch.

1. In the browser select the Switch number.
2. Highlight the 'StateUsrTxtOff' parameter and type in the appropriate text.
3. Repeat for 'StateUsrTxtOn'

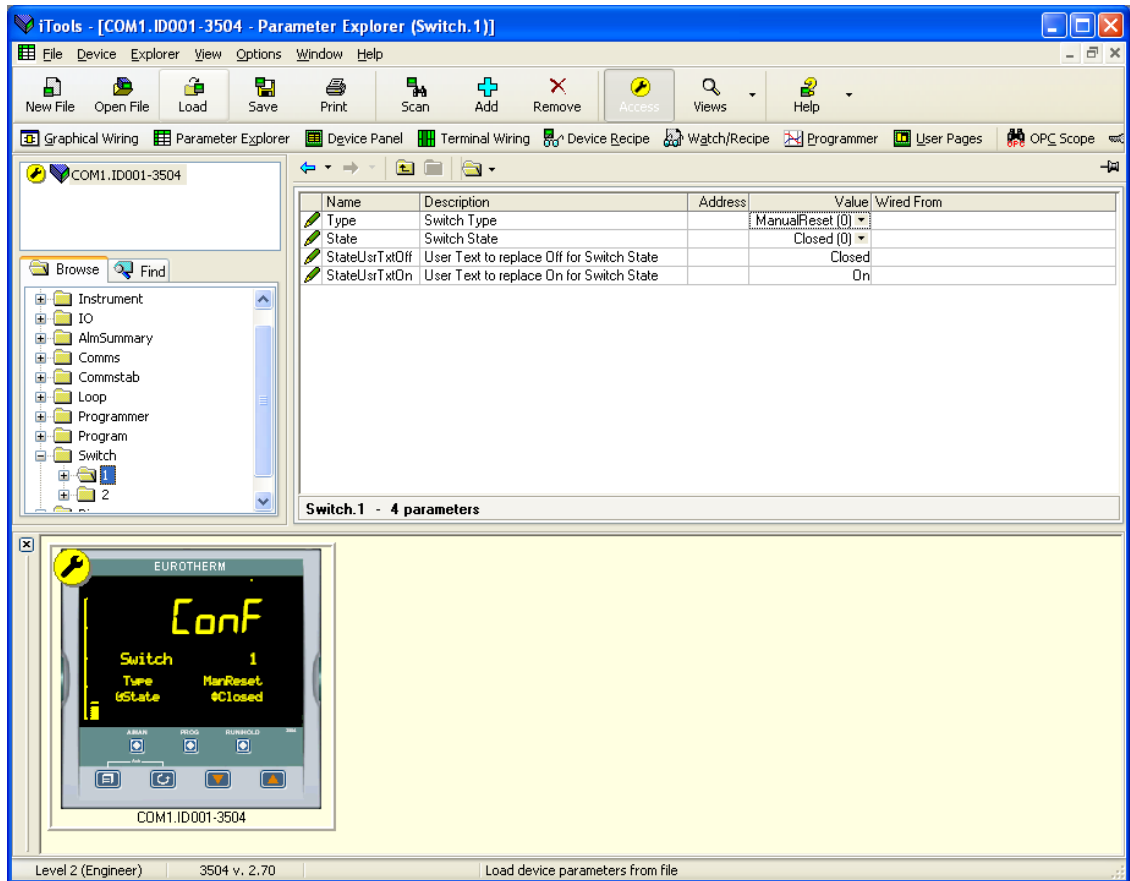

### 27.20 Master Communications Configuration Example

Master Communications is described in section 14.9.

This example uses typical features of the Master Comms function blocks to create an application using a single master - controller type 3508 communicating with 5 slaves as follows:-

Slave 1 - 2404 - address 2

Slave 2 - 2704 - address 3

Slave 3 - ePower - address 4

Slave 4 - 3216 - address 5

Slave 5 - 3504 - address 6

The master in this example uses port H to communicate with the slaves and port J to communicate with iTools. The screen shots shown in this section are taken from iTools and show the complete lists of parameters for each instrument.

The wiring may be EIA485/422 as appropriate. See section 14.8.2.

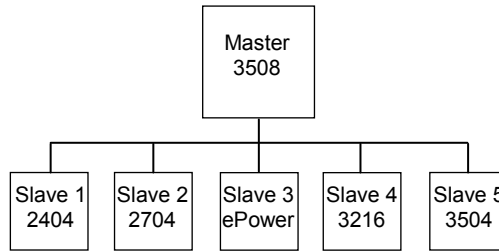

**Tab 1 - Master Comms Block 1**

Each tab in the iTools view corresponds to a Master Comms block. In Tab 1 the Master is set up to continuously write Target Setpoint (parameter address 2) to 2404 Slave 1 at instrument address 2 using Function Code 6. The Target Setpoint in this example is wired to the Programmer 1 PSP so that defined slaves follow a program set up in the master. This data appears in parameter Slave Data 1. Function code 6 - Write a Single Word is used and the Count parameter is not relevant and is, therefore, not shown.



**Note:** The Master Comms Block is disabled when in configuration mode to allow it to be set up. This is regardless of the setting of the parameter 'Enable'. However, to enable the block when exiting from configuration mode, set 'Enable' = 'Yes'.

Name	Description	Address	Value	Wired From
Mode	Block Mode		Cont (0)	
Enable	Master Comms Block Enable		Yes (1)	UsrVal.1.Val
Port	Master Comms Port		H (0)	
SuspendCount	Failure Count Before Suspen		5	
SuspendExceec	Suspend Count Exceeded		No (0)	
SuspendRetry	Suspend Retry Interval		30s ...	
Node	Slave Instrument Node Addr		2	
Func	Modbus Function Code		Func06 (6)	
Address	Parameter Address		2	
SlvData1	Slave Data 1		59.620	Programmer.1.Run.PSP
Format	Data Format		Sign (0)	
Factor	Data Factor		1.000	
Offset	Data Offset		0.000	
ExceptionCode	Last Modbus Exception Code		0	
TransactCount	Total Transaction Count		486060	
SuccessCount	Successful Transaction Cour		486060	
ErrorCount	Message Error Count		0	
ExceptionCount	Exception Count		0	

In this example, if 5 consecutive failures should occur during operation, master communications will be suspended. A retry will occur after 30 seconds.

**Tab 2 - Master Comms Block 2**

2704 Slave 2 is set up in Tab 2. The Master is continuously writing Target Setpoint (parameter address 2) to Slave 2 at instrument address 3 using Function Code 6. The Target Setpoint for slave 2 is wired to the programmer PSP, 'Programmer.1.Run.PSP'.

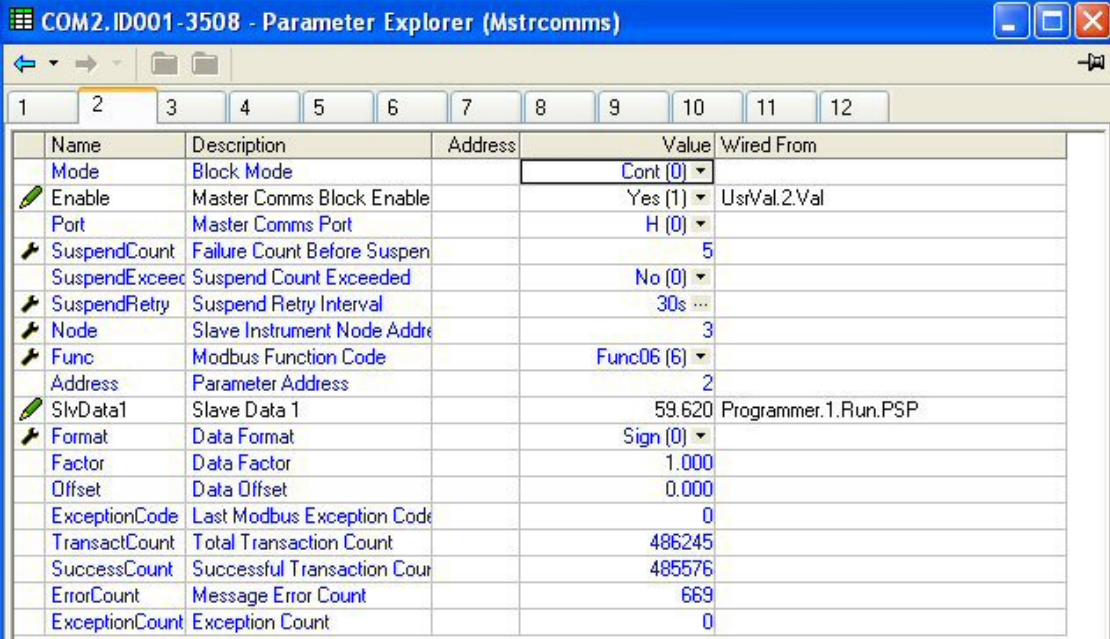

Name	Description	Address	Value	Wired From
Mode	Block Mode		Cont (0)	
Enable	Master Comms Block Enable		Yes (1)	UsrVal.2.Val
Port	Master Comms Port		H (0)	
SuspendCount	Failure Count Before Suspend		5	
SuspendExceed	Suspend Count Exceeded		No (0)	
SuspendRetry	Suspend Retry Interval		30s ...	
Node	Slave Instrument Node Address		3	
Func	Modbus Function Code		Func06 (6)	
Address	Parameter Address		2	
SlvData1	Slave Data 1		59.620	Programmer.1.Run.PSP
Format	Data Format		Sign (0)	
Factor	Data Factor		1.000	
Offset	Data Offset		0.000	
ExceptionCode	Last Modbus Exception Code		0	
TransactCount	Total Transaction Count		486245	
SuccessCount	Successful Transaction Count		485576	
ErrorCount	Message Error Count		669	
ExceptionCount	Exception Count		0	

**Tab 3 - Master Comms Block 3**

EPower Slave 3 is set up in Tab 3. The Master is continuously writing Remote Setpoint 1 (parameter address 1294) to Slave 3 at instrument address 4 using Function Code 6. The Target Setpoint for Slave 3 is wired to the programmer PSP, 'Programmer.1.Run.PSP'.

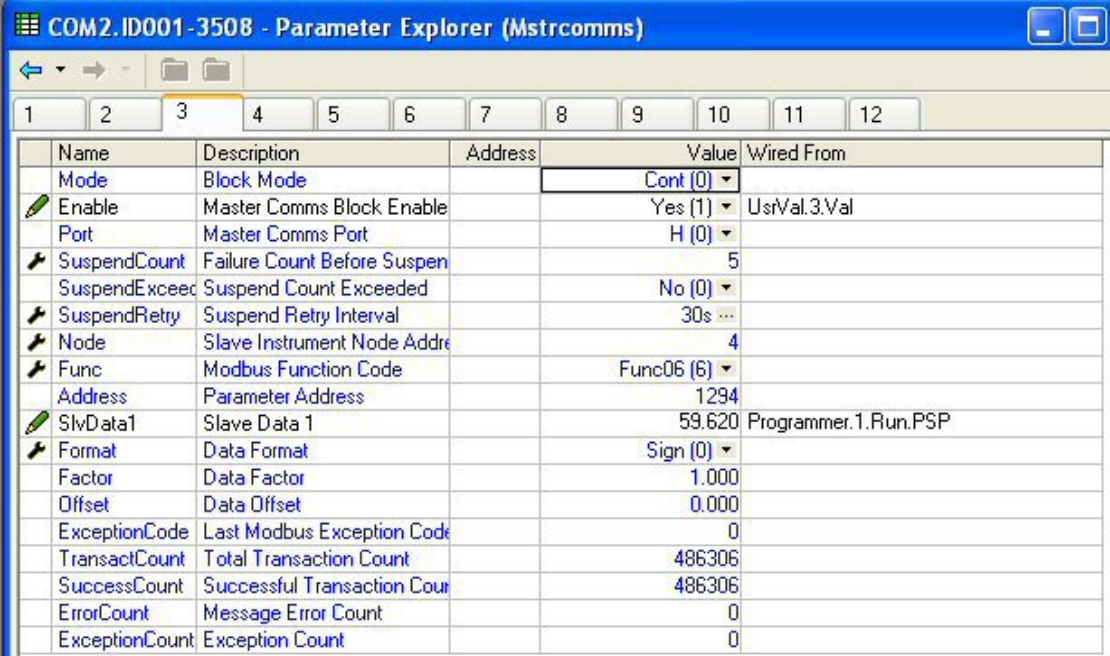

Name	Description	Address	Value	Wired From
Mode	Block Mode		Cont (0)	
Enable	Master Comms Block Enable		Yes (1)	UsrVal.3.Val
Port	Master Comms Port		H (0)	
SuspendCount	Failure Count Before Suspend		5	
SuspendExceed	Suspend Count Exceeded		No (0)	
SuspendRetry	Suspend Retry Interval		30s ...	
Node	Slave Instrument Node Address		4	
Func	Modbus Function Code		Func06 (6)	
Address	Parameter Address		1294	
SlvData1	Slave Data 1		59.620	Programmer.1.Run.PSP
Format	Data Format		Sign (0)	
Factor	Data Factor		1.000	
Offset	Data Offset		0.000	
ExceptionCode	Last Modbus Exception Code		0	
TransactCount	Total Transaction Count		486306	
SuccessCount	Successful Transaction Count		486306	
ErrorCount	Message Error Count		0	
ExceptionCount	Exception Count		0	



**Tab 4 - Master Comms Block 4**

3216 Slave 4 is set up in Tab 4. The Master is continuously writing Target Setpoint (parameter address 2) to Slave 4 at instrument address 5 using Function Code 6. The Target Setpoint for slave 4 is wired to the programmer PSP, 'Programmer.1.Run.PSP'.

The screenshot shows the 'Parameter Explorer' window for 'COM2.ID001-3508 - Parameter Explorer (Mstrcomms)'. The 'Tab' bar at the top is set to '4'. The table below lists the parameters for this block.

Name	Description	Address	Value	Wired From
Mode	Block Mode		Cont (0)	
Enable	Master Comms Block Enable		Yes (1)	UsrVal.4.Val
Port	Master Comms Port		H (0)	
SuspendCount	Failure Count Before Suspend		5	
SuspendExceed	Suspend Count Exceeded		No (0)	
SuspendRetry	Suspend Retry Interval		30s ...	
Node	Slave Instrument Node Address		5	
Func	Modbus Function Code		Func06 (6)	
Address	Parameter Address		2	
SlvData1	Slave Data 1		59.620	Programmer.1.Run.PSP
Format	Data Format		Unsign (1)	
Factor	Data Factor		1.000	
Offset	Data Offset		0.000	
ExceptionCode	Last Modbus Exception Code		0	
TransactCount	Total Transaction Count		486349	
SuccessCount	Successful Transaction Count		486349	
ErrorCount	Message Error Count		0	
ExceptionCount	Exception Count		0	

**Tab 5 - Master Comms Block 5**

3504 Slave 5 is set up in Tab 5. The Master is continuously writing Target Setpoint (parameter address 2) to Slave 5 at instrument address 6 using Function Code 6. The Target Setpoint for slave 5 is wired to the programmer PSP, 'Programmer.1.Run.PSP'.

The screenshot shows the 'Parameter Explorer' window for 'COM2.ID001-3508 - Parameter Explorer (Mstrcomms)'. The 'Tab' bar at the top is set to '5'. The table below lists the parameters for this block.

Name	Description	Address	Value	Wired From
Mode	Block Mode		Cont (0)	
Enable	Master Comms Block Enable		Yes (1)	UsrVal.5.Val
Port	Master Comms Port		H (0)	
SuspendCount	Failure Count Before Suspend		5	
SuspendExceed	Suspend Count Exceeded		No (0)	
SuspendRetry	Suspend Retry Interval		30s ...	
Node	Slave Instrument Node Address		6	
Func	Modbus Function Code		Func06 (6)	
Address	Parameter Address		2	
SlvData1	Slave Data 1		59.620	Programmer.1.Run.PSP
Format	Data Format		Sign (0)	
Factor	Data Factor		1.000	
Offset	Data Offset		0.000	
ExceptionCode	Last Modbus Exception Code		0	
TransactCount	Total Transaction Count		486392	
SuccessCount	Successful Transaction Count		486392	
ErrorCount	Message Error Count		0	
ExceptionCount	Exception Count		0	



**Tab 6 - Master Comms Block 6**

The master is set up to read data from 16 consecutive Modbus parameter addresses from 2404 Slave 1 - instrument address 2. The parameters start at parameter address 1 using Function Code 3 (read 16 words from the slave).

SlvData1 is Loop 1 main PV	Address 1
SlvData2 is Target SP	Address 2
SlvData3 is Target Output power	Address 3
SlvData4 Working output power	Address 4
SlvData5 is Working SP	Address 5
SlvData6 Proportional band set 1	Address 6

Further Modbus addresses for 2404 series instruments may be found in 2000 series Communications Manual HA026230, which may be downloaded from [www.eurotherm.com](http://www.eurotherm.com), or from iTools.

Name	Description	Address	Value	Wired From
Mode	Block Mode		Cont (0)	
Enable	Master Comms Block Enable		Yes (1)	UsrVal.6.Val
Port	Master Comms Port		H (0)	
SuspendCount	Failure Count Before Suspend		5	
SuspendExceed	Suspend Count Exceeded		No (0)	
SuspendRetry	Suspend Retry Interval		30s ...	
Node	Slave Instrument Node Address		2	
Func	Modbus Function Code		Func03 (3)	
Address	Parameter Address		1	
Count	Item Count		16	
SlvData1	Slave Data 1		9999.000	
SlvData2	Slave Data 2		62.000	
SlvData3	Slave Data 3		0.000	
SlvData4	Slave Data 4		0.000	
SlvData5	Slave Data 5		62.000	
SlvData6	Slave Data 6		20.000	
SlvData7	Slave Data 7		1.000	
SlvData8	Slave Data 8		9999.000	
SlvData9	Slave Data 9		360.000	
SlvData10	Slave Data 10		200.000	
SlvData11	Slave Data 11		0.000	
SlvData12	Slave Data 12		850.000	
SlvData13	Slave Data 13		0.000	
SlvData14	Slave Data 14		-1999.000	
SlvData15	Slave Data 15		0.000	
SlvData16	Slave Data 16		0.000	
Format	Data Format		Sign (0)	
Factor	Data Factor		1.000	
Offset	Data Offset		0.000	
ExceptionCode	Last Modbus Exception Code		0	
TransactCount	Total Transaction Count		486449	

Mstrcomms.6 - 34 parameters

**Note:**

In some cases it may be required to access a number of contiguous parameters from the slave. An example might be the 4 alarm setpoints from the slave. If the slave is 3500 series the alarm threshold addresses are 10241, 10256, 10273 and 10289 respectively. For 3500 series instruments these may be set up in the Comms Indirection Table as described in sections 14.7 and 30.

Other slaves may not support this feature

**Tab 7 - Master Comms Block 7**

The master is set up to read data from 16 consecutive Modbus parameter addresses from 2704 Slave 2 - instrument address 3. The parameters start at parameter address 1 using Function Code 3 (read 16 words from the slave).

Name	Description	Address	Value	Wired From
Mode	Block Mode		Cont (0)	
Enable	Master Comms Block Enable		Yes (1)	UsrVal.7.Val
Port	Master Comms Port		H (0)	
SuspendCount	Failure Count Before Suspen		0	
Node	Slave Instrument Node Addr		3	
Func	Modbus Function Code		Func03 (3)	
Address	Parameter Address		1	
Count	Item Count		16	
SlvData1	Slave Data 1		-962.500	
SlvData2	Slave Data 2		8.300	
SlvData3	Slave Data 3		0.000	
SlvData4	Slave Data 4		0.000	
SlvData5	Slave Data 5		8.300	
SlvData6	Slave Data 6		2.000	
SlvData7	Slave Data 7		0.000	
SlvData8	Slave Data 8		36.000	
SlvData9	Slave Data 9		6.000	
SlvData10	Slave Data 10		-3276.800	
SlvData11	Slave Data 11		-999.900	
SlvData12	Slave Data 12		-3107.300	
SlvData13	Slave Data 13		0.000	
SlvData14	Slave Data 14		0.000	
SlvData15	Slave Data 15		0.000	
SlvData16	Slave Data 16		0.000	
Format	Data Format		Sign (0)	
Factor	Data Factor		10.000	
Offset	Data Offset		0.000	
ExceptionCode	Last Modbus Exception Code		0	
TransactCount	Total Transaction Count		486490	
SuccessCount	Successful Transaction Count		484696	
ErrorCount	Message Error Count		1793	

**Mstrcomms.7 - 32 parameters (2 hidden)**

## 28. Chapter 28 OEM Security

### 28.1 Introduction

OEM security allows users, typically OEMs or distributors, to be able to protect their intellectual property by preventing unauthorised cloning of controller configurations.

OEM security is only available as a special order and is identified by special number EU0722 which appears on the label showing the order code.

The feature provides the user with the ability to enter an **OEM Security Password**, after which, unless the password is entered, it inhibits iTools from communicating with the controller in its normal way.



- Notes:**
1. When using the controller through its front panel buttons it will not be possible to view or configure the wiring between blocks (section 5.1) but all HMI parameters will be visible and alterable as normal.
  2. The Setpoint Program Editor in iTools cannot be used while OEM Security is active, neither can a program be operated (run, held or reset) through iTools. Programs can, however, be edited and operated through the controller front panel buttons
  3. It will still be possible to access communication parameters via the SCADA table.
  4. If features such as OPC Scope are required then Custom Tags may be used to access the SCADA area.

### 28.2 Using OEM Security

The OEM Security feature enables three new addresses to become active in the SCADA region. These are:-

1. Address 16116, 'Locked': this is a read only Boolean parameter that returns 1 (TRUE) when the instrument is OEM secured.
2. Address 16117, 'Lock Code': this is a write only parameter which will read back as 0. When the instrument is unlocked, a value entered here will lock the instrument and defines the code needed to unlock. The code and locked status will be saved in non-volatile memory.
3. Address 16118, 'Unlock Code': this is a write only parameter which will read back as 0. When the instrument is locked, a value entered here will be compared with the lock code. If it is the same, the instrument will be unlocked. If the value is different, this parameter will become unavailable for a time period. This time will increase for each failed attempt.

These addresses are not available by default in iTools. It is, therefore, necessary to create Custom Tags in iTools to be able to write or read these parameters. The following procedure shows how to do this and how to use the OEM security features.

### 28.3 Step 1 – View iTools OPC Server

With iTools open and connected to the target instrument open the iTools OPC server using Options>Advanced>Show Server.

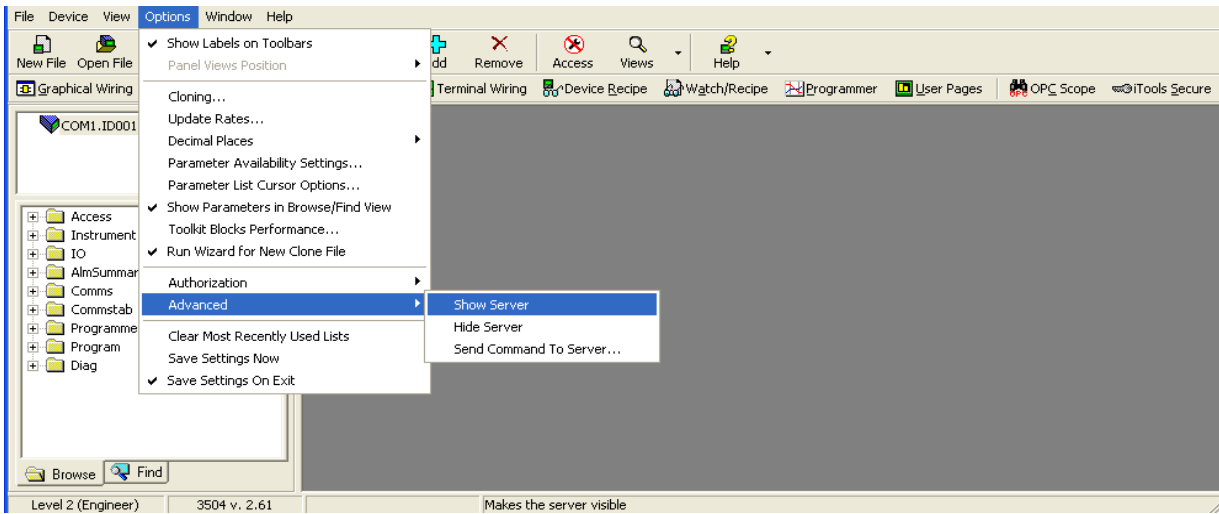

Click on the OPC Server application on your windows Taskbar to view the server.

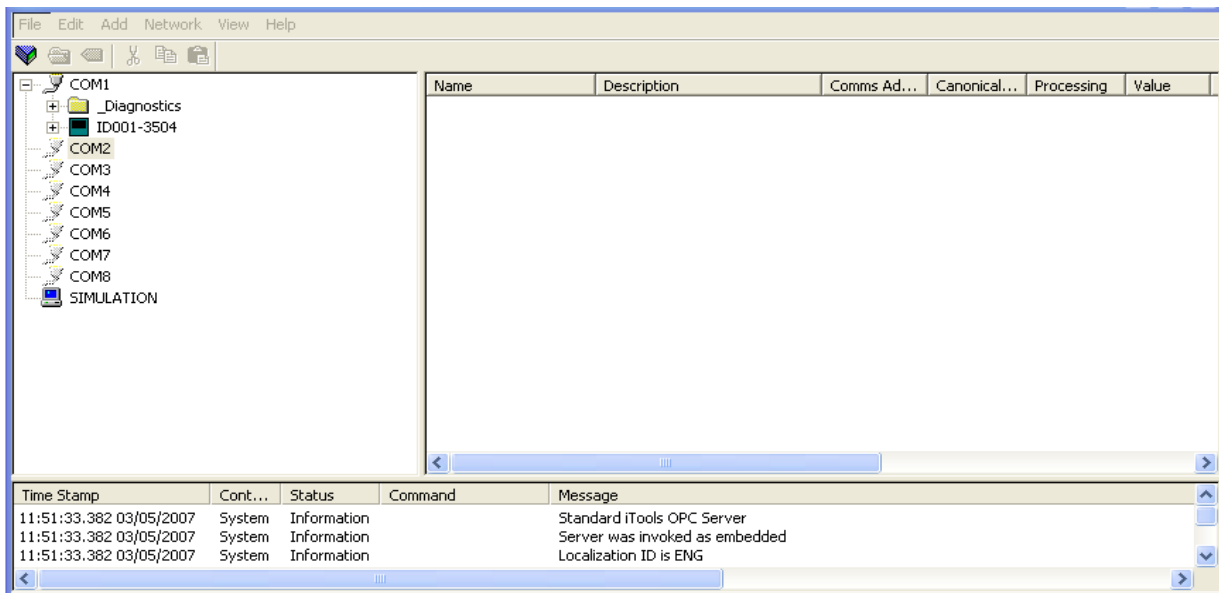

### 28.4 Step 2 – Create Custom Tags

Expand the connected instrument to show all folders. Close to the bottom of the tree you will find a folder called CustTags.

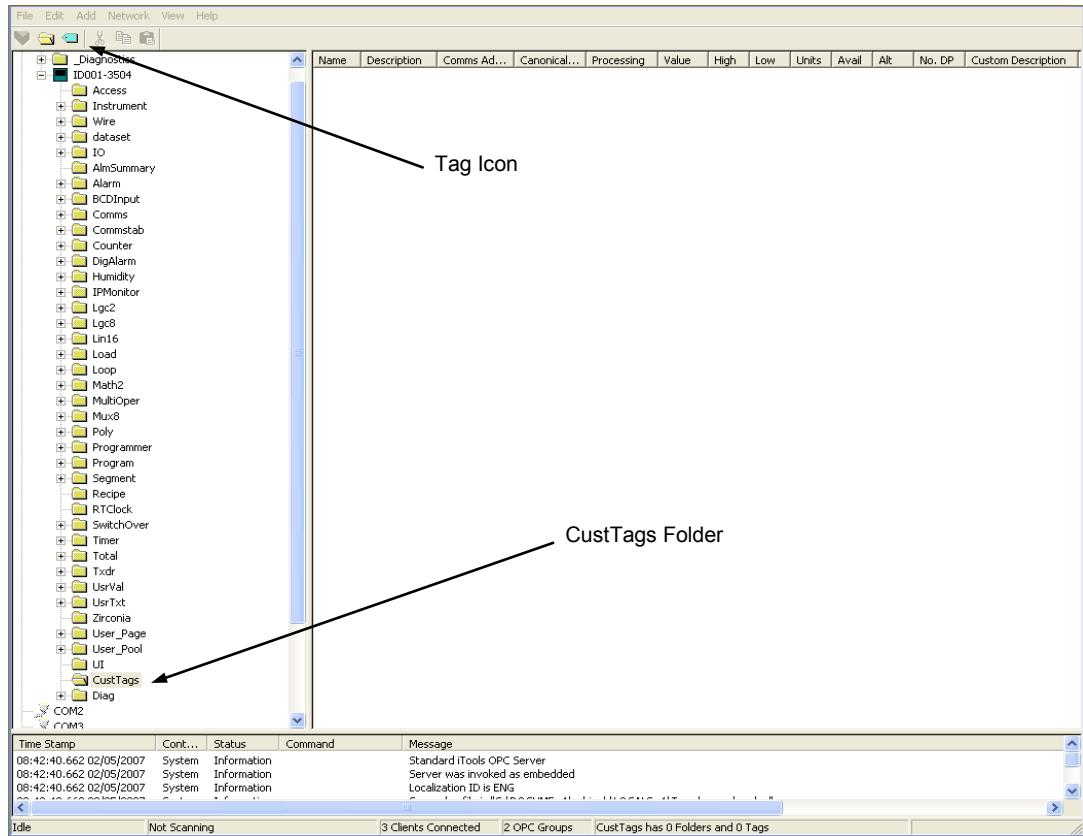

Click on CustTags then click on the Tag icon on the Toolbar. Enter the name of the Tag as 'Locked' and its address as 16116 then press OK. Repeat for the 'Lock' and 'Unlock Code' addresses

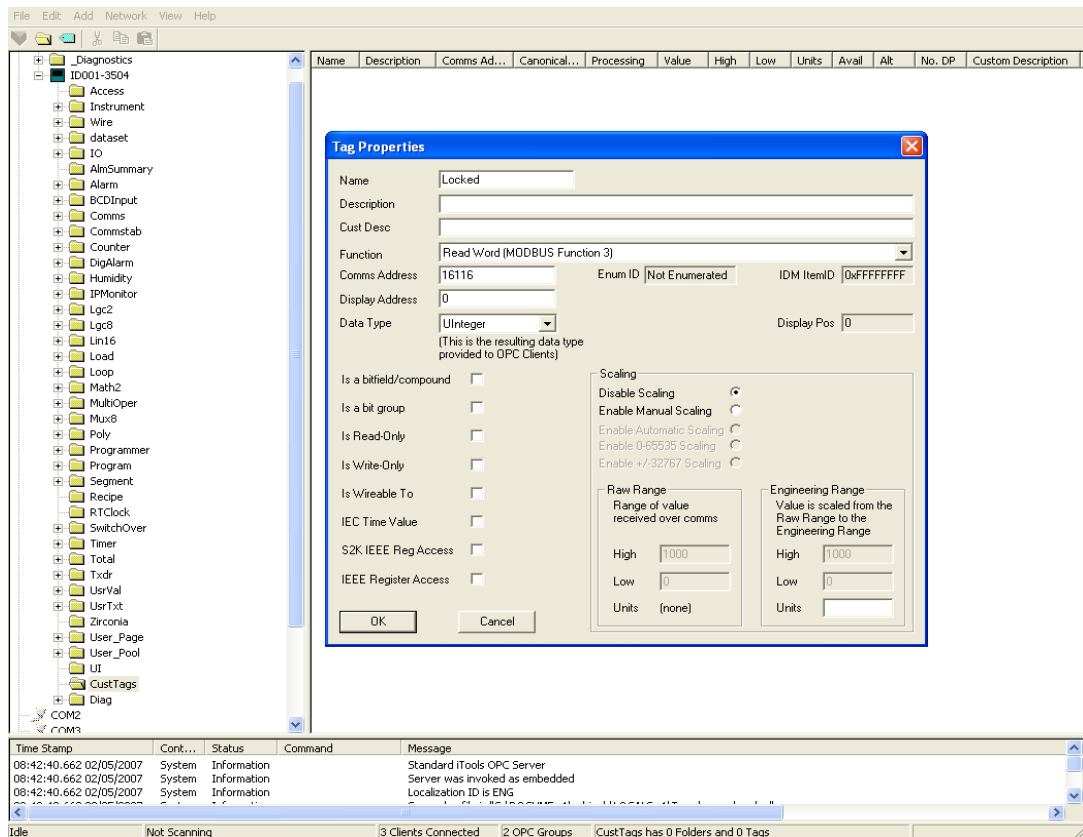

When all three Tags are created you will see the following:-

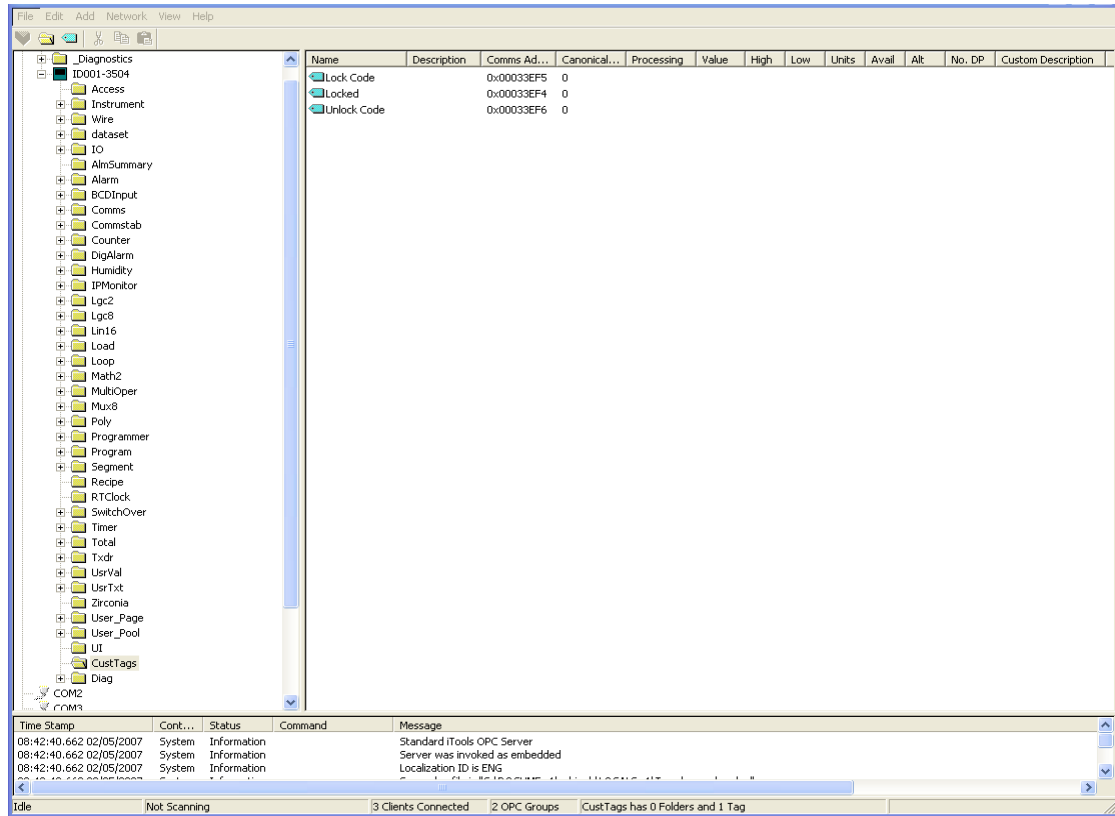

Minimise (do not close) the OPC server to the taskbar and return to iTools. You can now select CustTags on the connected 3500 by double clicking on the folder when in the browse tab.

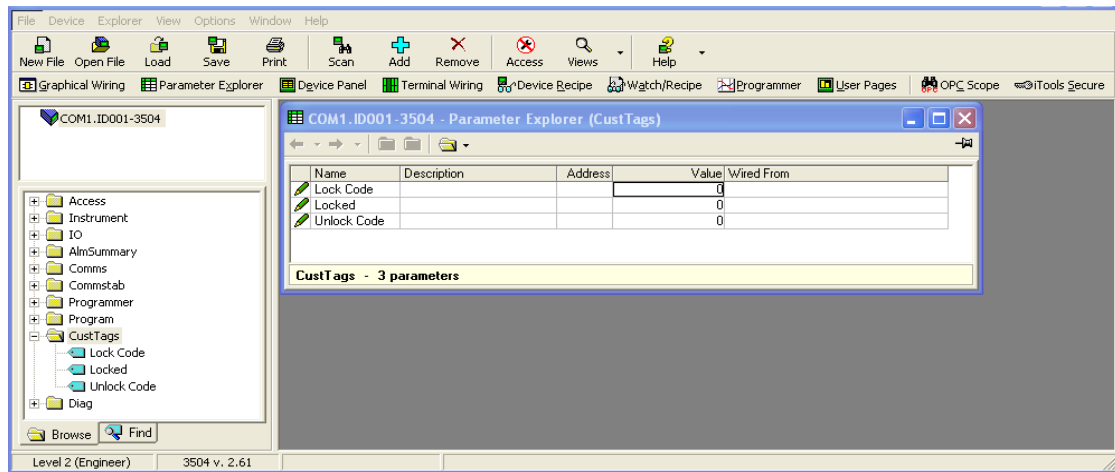

### 28.5 Step 3 – Activate OEM Security

At the same time as viewing the CustTag parameters double click on another folder and position it show that you can see parameters from both.

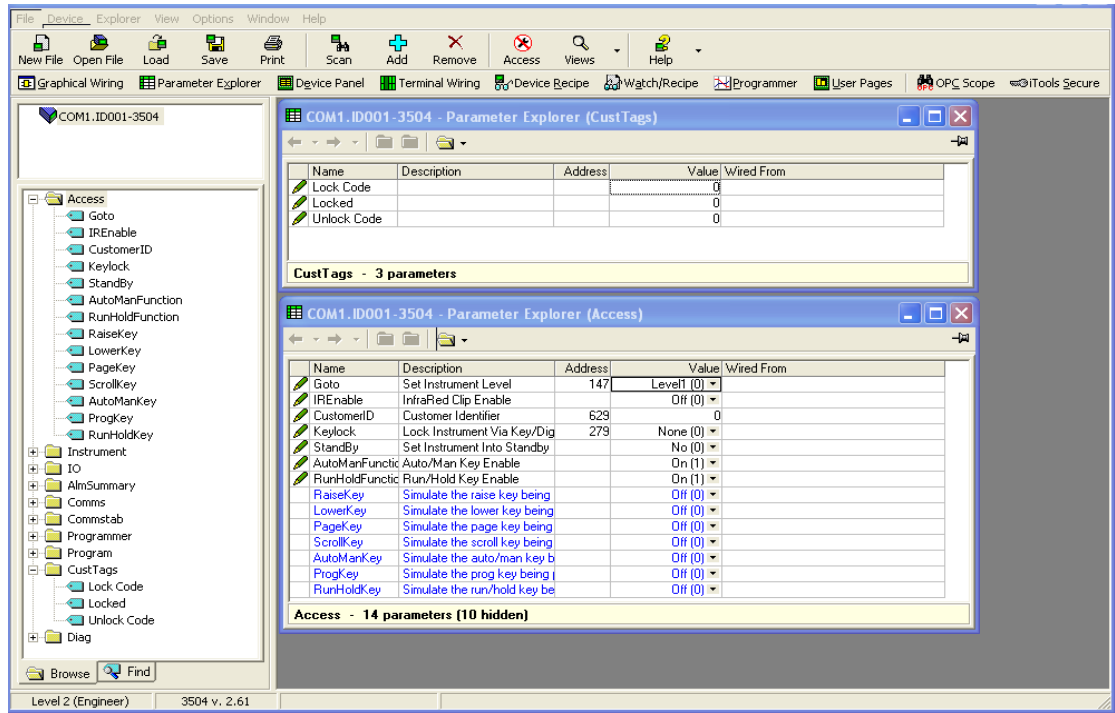

Enter a numerical code for the parameter 'Lock Code' and notice that the 'Locked' parameter now shows true(1) and the parameters in the other folder now show question marks indicating that iTools is no longer reading them.

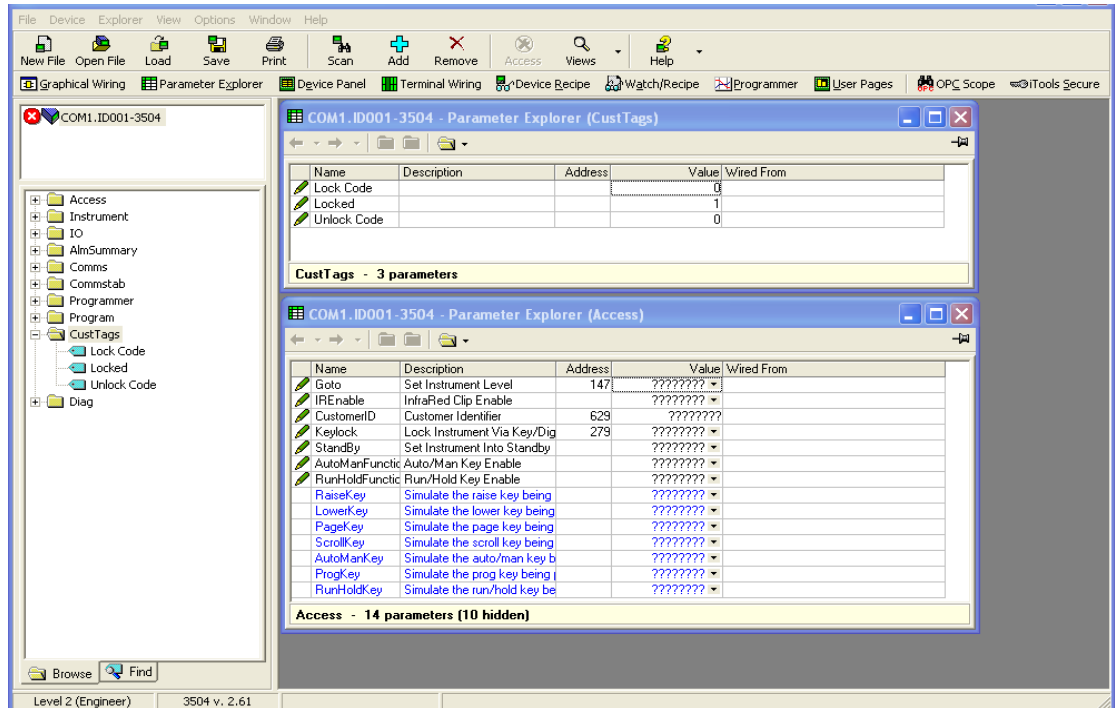

## 28.6 Step 4 – Deactivate OEM Security

Enter the code you used in step 3 into 'Unlock Code' to enable full iTools communication.

If an incorrect code is entered this parameter will become unavailable for a time period, indicated by a warning message 'Failed to write data to device'. This time will increase for each failed attempt limited to 1 minute. If the correct code is entered while the time delay is in operation it will not be accepted. It will be necessary to wait until the time delay is no longer operative (up to 1 minute) or to power cycle the controller.

## 28.7 Erasing Memory

Since the OEM Lock/Unlock code is retained in 'normal' non-volatile memory, it may be erased by use of the Access.ClearMemory (Cold Start) parameter, see section 3.4. Using this parameter to erase AllMemory will not only unlock the OEM Security but it will also erase the application being protected.



**Note:** The instrument must be in Config mode to accept the ClearMemory command

This process may also be done via the SCADA area. The Instrument Mode parameter is already in the SCADA area at address 199 - write a value of 2 to set Config mode. The Clear Memory parameter will be found at address 16119. Set a value of 5 (AllMemory) to clear the memory.



## 29. Chapter 29 User Switches

The User Switch Function Block has been added from software version 2.70+.

A User Switch provides a general purpose boolean switch. It is most useful when incorporated in a User Page where it can perform a specific task suited to the particular application. Eight User Switches are available and each may be configured as:-



Auto Reset - the switch remains On for a minimum of 110ms after which is is automatically set to Off.

Manual Reset – the switch remains On until it is set to Off manually.

The text associated with the State parameter (Off / On by default) may be changed using iTools to suit the application requirements.







### 29.1 User Switch Parameters

The parameters are only available if one or more User Switch function blocks are enabled (see section 6.3.1). Use  to page to the **Switch** heading.

List Header – Switch		Sub-headers: 1 to 8			
Name  to select	Parameter Description	Value Press  or  to change values		Default	Access Level
Type	The selected switch may be configured as Manual or Automatic reset	ManReset	the switch remains On until it is set to Off manually.	ManReset	Conf
		AutoReset	the switch remains On for a minimum of 110ms after which is is automatically set to Off.		
State	Shows the state of the switch. It is normal to wire this parameter to a digital function within the controller such as a programmer event. The state of the switch is then determined by the event. If it is not wired then the state may changed here.	Off *	Switch off	Off	L3
		On *	Switch on		

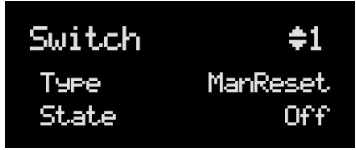
- The text associated with the switch may be configured in iTools so that it displays a more meaningful message. Examples are, Open/Closed, Up/Down, etc. See section 27.19 for further details.

### 29.2 To Configure User Switches

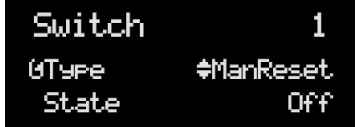
Do This	The Display You Should See	Additional Notes
1. From any display press  as many times as necessary to select Switch 2. Select the required switch number using  or 		
3. Press  to select switch Type and  or  to select AutoReset or manReset		Repeat 3 to select State. The state may be changed if not wired.

### 30. Chapter 30 MODBUS SCADA TABLE

The SCADA table provides fixed single register Modbus values for use with Third Party Modbus masters in SCADA packages or plcs. If parameters are not available in this table they can be added from an indirection table using their Modbus addresses. Scaling of the parameters has to be configured – the Modbus master scaling has to match the 3500 parameter resolution to ensure the decimal point is in the correct position.



**This facility is intended for use by suitably qualified personnel responsible for developing SCADA or plc interfaces.**

#### 30.1 Comms Table

The tables that follow do not include every parameter in the 3500. The Comms Table is used to make most parameters available at any SCADA address. See also section 14.7.

Folder – Commstab		Sub-folders: .1 to .250		
Name	Parameter Description	Value	Default	Access Level
Destination	Modbus Destination	Not Used; 0 to 16011	Not used	Conf
Source	Source Parameter	Taken from source parameter		Conf
Native	Native Data Format	0 Integer 1 Native (i.e. Float or long)	Integer	Conf
ReadOnly	Read Only Read/Write only if source is R/W	0 Read/Write 1 Read Only	R/W	Conf
Minutes	Minutes Units in which time is scaled.	0 Seconds 1 Minutes	Seconds.	Conf

It is recommended that iTools should be used to set up the required table. Entering a value in the Source parameter may be done in two ways:

- 1 - drag the required parameter into the Source
- 2 - right click the Source parameter, select Edit Wire and browse to the required parameter.

In the Example below the PV of Loop 1 would be available at addresses 200 and 201 as a two register floating point number - its native data type.

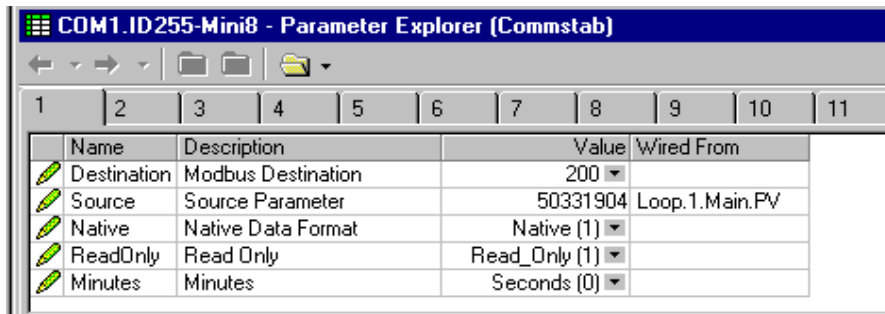

There are 250 comms table entries available.

#### 30.2 SCADA Addresses

The address field in iTools displays the parameter's Modbus address. These addresses should be used when accessing parameters over comms. If a parameter has no address the CommsTab feature can be used to map the parameter to a modbus address, however, it should be noted that the address field will not be updated. The following Modbus addresses have been reserved for use with the CommsTab Function Block, by default they have no associated parameter:

ModBus Range	Modbus Range (HEX)
15360 to 15615	0x3C00 to 0x3CFF

### 30.3 SCADA Table and Profibus Tag Addresses

The following table lists the parameters, along with their limits and resolution, which have assigned Modbus addresses. They are available in scaled integer format. The MODBUS address is the same as the tag address for Profibus (see also section 14.5).

Wherever possible use an OPC client with the iTools OPCserver as the server. In this arrangement the parameters are all referenced by name and the values are floating point so the decimal point for all parameters is inherited.

Some parameters have more than one address, for example 'Alarm1.Block'. The lower number is to maintain a compatibility with earlier instruments. Either address may be used although the higher number is specific to 3000 series.

MODBUS	MODBUS (Hex)	Parameter	Enumerations
1	0x0001	Loop.1.Main.PV	
2	0x0002	Loop.1.Main.TargetSP	
3	0x0003	Loop.1.OP.ManualOutVal	
4	0x0004	Loop.1.Main.ActiveOut	
5	0x0005	Loop.1.Main.WorkingSP	
6	0x0006	Loop.1.PID.ProportionalBand	
7	0x0007	Loop.1.Setup.ControlAction	0 Reverse; 1 Direct
8	0x0008	Loop.1.PID.IntegralTime	0 Off
9	0x0009	Loop.1.PID.DerivativeTime	0 Off
11	0x000b	Loop.1.SP.RangeLow	
12	0x000c	Loop.1.SP.RangeHigh	
13	0x000d	Alarm.1.Threshold	
14	0x000e	Alarm.2.Threshold	
15	0x000f	Loop.1.SP.SPSelect	0 Setpoint 1; 1 Setpoint 2
16	0x0010	Loop.1.OP.Ch2Deadband	0 Off
17	0x0011	Loop.1.PID.CutbackLow	0 Auto
18	0x0012	Loop.1.PID.CutbackHigh	0 Auto
19	0x0013	Loop.1.PID.RelCh2Gain	
21	0x0015	Loop.1.OP.Ch1TravelTime	
24	0x0018	Loop.1.SP.SP1	
25	0x0019	Loop.1.SP.SP2	
27	0x001b	Loop.1.SP.SPTrim	
28	0x001c	Loop.1.PID.ManualReset	
30	0x001e	Loop.1.OP.OutputHighLimit	
31	0x001f	Loop.1.OP.OutputLowLimit	
34	0x0022	Loop.1.OP.SafeOutVal	
35	0x0023	Loop.1.SP.Rate	
37	0x0025	Loop.1.OP.Rate	
38	0x0026	PV.Emissivity	
39	0x0027	Loop.1.Diag.Error	
45	0x002d	LgcIO.LA.MinOnTime	
46	0x002e	Loop.1.OP.PotCalibrate	0 OFF; 1 Calibrate Ch1 position input; 2 Calibrate Ch2 position input
47	0x002f	Alarm.1.Hysteresis	
48	0x0030	Loop.1.PID.ProportionalBand2	
49	0x0031	Loop.1.PID.IntegralTime2	0 Off
50	0x0032	Loop.1.PID.ManualReset2	
51	0x0033	Loop.1.PID.DerivativeTime2	0 Off
52	0x0034	Loop.1.PID.RelCh2Gain2	
53	0x0035	Loop.1.OP.Ch1PotPosition	
54	0x0036	LgcIO.LA.MinOnTime	
55	0x0037	Loop.1.Diag.IntegralOutContrib	
66	0x0042	Loop.1.SP.SPTrimHighLimit	
67	0x0043	Loop.1.SP.SPTrimLowLimit	
68	0x0044	Alarm.2.Hysteresis	
69	0x0045	Alarm.3.Hysteresis	
71	0x0047	Alarm.4.Hysteresis	
72	0x0048	Loop.1.PID.ActiveSet	1 set 1; 2 set 2; 3 set 3; 4 set 4; 5 set 5; 6

MODBUS	MODBUS (Hex)	Parameter	Enumerations
			set 6
73	0x0049	Instrument.Diagnostics.ErrCount	
78	0x004e	Loop.1.SP.RateDisable	0 No; 1 Yes
81	0x0051	Alarm.3.Threshold	
82	0x0052	Alarm.4.Threshold	
83	0x0053	Loop.1.PID.LoopBreakTime	0 off
84	0x0054	Loop.1.OP.ManualOutVal	
85	0x0055	Loop.1.OP.Ch1Out	
86	0x0056	Loop.1.OP.Ch1OnOffHysteresis	
88	0x0058	Loop.1.OP.Ch2OnOffHysteresis	
89	0x0059	LgcIO.LB.MinOnTime	0 auto
96	0x0060	BCDInput.1.BCDVal	
97	0x0061	Loop.1.OP.FeedForwardGain	
98	0x0062	Loop.1.OP.FeedForwardOffset	
99	0x0063	Loop.1.OP.FeedForwardTrimLimit	
101	0x0065	PV.FilterTimeConstant	0 off
103	0x0067	Mod.3.A.FilterTimeConstant	0 off
104	0x0068	Mod.3.A.Emissivity	0 off
105	0x0069	BCDInput.2.BCDVal	
106	0x006a	Instrument.Display.HomePage	0 access page; 1 loop summary; 2 program summary; 3 custom page 1; 4 custom page 2; 5 custom page 3; 6 custom page 4; 7 custom page 5; 8 custom page6; 9 custom page 7; 10 custom page 8
107	0x006b	Instrument.InstInfo.Version	
111	0x006f	Loop.1.SP.SPHighLimit	
112	0x0070	Loop.1.SP.SPLowLimit	
116	0x0074	Loop.1.Diag.DerivativeOutContrib	
117	0x0075	Loop.1.PID.CutbackLow2	
118	0x0076	Loop.1.PID.CutbackHigh2	
121	0x0079	Instrument.InstInfo.CompanyID	
122	0x007a	Instrument.InstInfo.InstType	0 3508; 1 3504
123	0x007b	LgcIO.LA.Inertia	
124	0x007c	LgcIO.LA.Backlash	
126	0x007e	Loop.1.OP.Ch2Out	
127	0x007f	Loop.1.OP.TrackEnable	0 off; 1 on
128	0x0080	Loop.1.OP.TrackOutVal	
131	0x0083	Comms.Address	
133	0x0085	IPMonitor.1.Max	
134	0x0086	IPMonitor.1.Min	
138	0x008a	IPMonitor.1.Threshold	
139	0x008b	IPMonitor.1.TimeAbove	
140	0x008c	IPMonitor.1.Reset	0 No; 1 Yes
141	0x008d	PV.Offset	
142	0x008e	Mod.3.A.Offset	
147	0x0093	Access.Goto	0 Level 1; 1 Level 2; 3 Level 3; 4 Configuration
152	0x0098	Loop.1.PID.Boundary2-3	
153	0x0099	Loop.1.PID.Boundary1-2	
155	0x009b	Loop.1.SP.SPHighLimit	
156	0x009c	Loop.1.SP.SPLowLimit	
181	0x00b5	Loop.1.PID.IntegralTime3	0 Off
182	0x00b6	Loop.1.PID.ManualReset3	
183	0x00b7	Loop.1.PID.DerivativeTime3	0 Off
184	0x00b8	Loop.1.PID.RelCh2Gain3	
185	0x00b9	Loop.1.PID.ActiveSet	
199	0x00c7	Access.IM	
201	0x00c9	Instrument.Diagnostics.MaxConTicks	
202	0x00ca	PV.MeasuredVal	
208	0x00d0	Mod.3.A.MeasuredVal	
209	0x00d1	Loop.1.OP.FeedForwardVal	

MODBUS	MODBUS (Hex)	Parameter	Enumerations
210	0x00d2	Loop.1.OP.PotCalibrate	
214	0x00d6	Loop.1.Diag.PropOutContrib	
215	0x00d7	PV.CJCTemp	
216	0x00d8	Mod.3.A.CJCTemp	
221	0x00dd	Alarm.1.Delay	
222	0x00de	Alarm.2.Delay	
223	0x00df	Alarm.3.Delay	
224	0x00e0	Alarm.4.Delay	
225	0x00e1	Txdr.1.StartTare	0 No; 1 Yes
226	0x00e2	Txdr.1.StartCal	0 No; 1 Yes
227	0x00e3	Txdr.2.StartTare	0 No; 1 Yes
228	0x00e4	Txdr.2.StartCal	0 No; 1 Yes
231	0x00e7	Txdr.1.StartHighCal	0 No; 1 Yes
232	0x00e8	Txdr.1.InLow	
233	0x00e9	Txdr.1.InHigh	
234	0x00ea	Txdr.1.ScaleLow	
235	0x00eb	Txdr.1.ScaleHigh	
236	0x00ec	Txdr.1.TareValue	
237	0x00ed	Txdr.1.CalAdjust	
238	0x00ee	Txdr.1.CalAdjust	
239	0x00ef	Txdr.2.StartHighCal	0 No; 1 Yes
240	0x00f0	Txdr.2.InLow	
241	0x00f1	Txdr.2.InHigh	
242	0x00f2	Txdr.2.ScaleLow	
243	0x00f3	Txdr.2.ScaleHigh	
244	0x00f4	Txdr.2.TareValue	
245	0x00f5	Txdr.2.CalAdjust	
246	0x00f6	Txdr.2.CalAdjust	
258	0x0102	Loop.1.Diag.SBrk	0 Off; 1 On
260	0x0104	AlmSummary.NewAlarm	0 No; 1 Yes
261	0x0105	AlmSummary.AnyAlarm	0 No; 1 Yes
263	0x0107	Loop.1.Diag.LoopBreakAlarm	0 No; 1 Yes
268	0x010c	Loop.1.Main.Inhibit	0 No; 1 Yes
269	0x010d	Loop.1.Tune.Stage	0 reset; 1 none; 2 monitor; 3 current SP; 4 newSP; 5 toSP; 6 max; 7 min; 8 store; 9 coolT; 10 PID; 11 abort; 12 complete
270	0x010e	Loop.1.Tune.AutotuneEnable	0 Off; 1 On
273	0x0111	Loop.1.Main.AutoMan	0 Auto; 1 Manual
274	0x0112	AlmSummary.GlobalAck	0 No; 1 Yes
276	0x0114	Loop.1.SP.AltSPSelect	0 No; 1 Yes
277	0x0115	Loop.1.SP.RateDone	0 No; 1 Yes
279	0x0117	Access.Keylock	0 None; 1 All
286	0x011e	SwitchOver.SwitchHigh	
287	0x011f	SwitchOver.SwitchLow	
288	0x0120	SwitchOver.SelectIn	0 Input 1 has been selected; 1 Input 2 has been selected; 2 Both inputs are used to calculate the input
290	0x0122	Mod.3.A.PV	
313	0x0139	Recipe.RecipeSelect	0 None; 1 Set 1; 2 Set 2; 3 Set 3; 4 Set 4; 5 Set 5; 6 Set 6; 7 Set 7; 8 Set 8
315	0x013b	Recipe.LastDataset	0 None; 1 Set 1; 2 Set 2; 3 Set 3; 4 Set 4; 5 Set 5; 6 Set 6; 7 Set 7; 8 Set 8
316	0x013c	Recipe.LoadingStatus	0 OK; 1 Loading; 2 Failed; 3 Denied
317	0x013d	Loop.1.OP.Ch1PotPosition	
318	0x013e	Loop.1.OP.Ch2PotPosition	
319	0x013f	Loop.1.OP.Ch2TravelTime	
350	0x015e	Loop.1.OP.Ch1PotBreak	0 Off; 1 On
360	0x0168	PV.PV	
361	0x0169	LgcIO.LA.PV	48 Logic input; 49 Contact closure; 50 Logic output; 51 Time proportioned output; 52 VP raise output; 53 VP lower output
362	0x016a	LgcIO.LB.PV	48 Logic input; 49 Contact closure; 50 Logic

MODBUS	MODBUS (Hex)	Parameter	Enumerations
			output; 51 Time proportioned output; 52 VP raise output; 53 VP lower output
363	0x016b	RlyAA.PV	50 On/Off; 51 Time proportion; 52 VP raise; 53 VP lower
364	0x016c	Mod.1.A.PV	
365	0x016d	Mod.1.B.PV	
366	0x016e	Mod.1.C.PV	
367	0x016f	Mod.2.A.PV	
368	0x0170	Mod.2.B.PV	
369	0x0171	Mod.2.C.PV	
370	0x0172	Mod.3.A.PV	
371	0x0173	Mod.3.B.PV	
372	0x0174	Mod.3.C.PV	
373	0x0175	Mod.4.A.PV	
374	0x0176	Mod.4.B.PV	
375	0x0177	Mod.4.C.PV	
376	0x0178	Mod.5.A.PV	
377	0x0179	Mod.5.B.PV	
378	0x017a	Mod.5.C.PV	
379	0x017b	Mod.6.A.PV	
380	0x017c	Mod.6.B.PV	
381	0x017d	Mod.6.C.PV	
485	0x01e5	Loop.1.SP.AltSP	
486	0x01e6	Loop.1.SP.SPTrim	
512	0x0200	Loop.1.Setup.CH1ControlType	0 Off; 1 On/Off; 2 PID; 3 VPU; 4 VPB
513	0x0201	Loop.1.Setup.CH2ControlType	0 Off; 1 On/Off; 2 PID; 3 VPU; 4 VPB
514	0x0202	Access.L2Passcode	
515	0x0203	Access.ConfPasscode	
516	0x0204	Instrument.Display.Units	0 Deg C; 1 Deg F; 2 Deg K
523	0x020b	Comms.Wait	0 No; 1 Yes
524	0x020c	Loop.1.OP.CoolType	0 Linear; 1 Oil; 2 Water; 3 Fan
526	0x020e	Loop.1.SP.SPTrack	0 Off; 1 On
527	0x020f	Loop.1.SP.ManualTrack	0 Off; 1 On
528	0x0210	Loop.1.SP.SPTrack	
532	0x0214	Loop.1.OP.FeedForwardType	0 FF disabled; 1 FF remote; 2 FF current setpoint; 3 PV
534	0x0216	PV.CalState	1 idle; 2 Low point volts; 3 high point volts; 4 factory default; 5 stored; 6 factory cal stored; 11 idle; 12 low point HZ input; 13 high point HZ input; 14 cal restored to factory default; 15 user cal stored; 16 factory cal stored; 20 factory rough cal point; 21 idle; 22 low point mV; 23 hi point mV; 24 cal restored to factory default; 25 user cal stored; 26 factory cal stored; 30 cal point for factory rough cal; 31 idle; 32 low point for mV; 33 hi point for mV; 34 cal restored to factory default; 35 user cal stored; 36 factory cal stored; 51 idle; 52 CJC cal used with Term temp parameter; 54 cal restored to factory default; 55 user cal stored; 56 factory cal stored; 200 confirmation of request to cal; 201 start cal; 202 abort cal; 210 cal point for factory rough cal; 212 cal in progress; 213 abort cal; 220 cal completed successfully; 221 cal accepted but not stored; 222 abort cal; 223 cal failed
548	0x0224	PV.RangeHigh	
549	0x0225	PV.RangeLow	
550	0x0226	Loop.1.Setup.DerivativeType	0 only PV changes cause changes to the derivative; 1 changes to either PV or SP will cause a change to the derivative output
553	0x0229	Loop.1.OP.SensorBreakMode	0 SbrkOP; 1 hold
554	0x022a	Access.L3Passcode	
556	0x022c	Loop.1.OP.ManualMode	0 track; 1 step; 2 lastMOP

MODBUS	MODBUS (Hex)	Parameter	Enumerations
565	0x0235	Loop.1.OP.EnablePowerFeedforward	0 no; 1 yes
578	0x0242	PV.SBrkType	0 off; 1 low; 2 high
601	0x0259	Lin16.InLowLimit	
602	0x025a	Lin16.In1	
603	0x025b	Lin16.In2	
604	0x025c	Lin16.In3	
605	0x025d	Lin16.In4	
606	0x025e	Lin16.In5	
607	0x025f	Lin16.In6	
608	0x0260	Lin16.In7	
609	0x0261	Lin16.In8	
610	0x0262	Lin16.In9	
611	0x0263	Lin16.In10	
612	0x0264	Lin16.In11	
613	0x0265	Lin16.In12	
614	0x0266	Lin16.In13	
615	0x0267	Lin16.In14	
616	0x0268	Lin16.InHighLimit	
618	0x026a	Lin16.In	
619	0x026b	Lin16.Out	
621	0x026d	Lin16.OutLowLimit	
622	0x026e	Lin16.Out1	
623	0x026f	Lin16.Out2	
624	0x0270	Lin16.Out3	
625	0x0271	Lin16.Out4	
626	0x0272	Lin16.Out5	
627	0x0273	Lin16.Out6	
628	0x0274	Lin16.Out7	
629	0x0275	Access.CustomerID	
630	0x0276	Lin16.Out8	
631	0x0277	Lin16.Out9	
632	0x0278	Lin16.Out10	
633	0x0279	Lin16.Out11	
634	0x027a	Lin16.Out12	
635	0x027b	Lin16.Out13	
636	0x027c	Lin16.Out14	
637	0x027d	Lin16.OutHighLimit	
1025	0x0401	Loop.2.Main.PV	
1026	0x0402	Loop.2.Main.TargetSP	
1027	0x0403	Loop.2.OP.ManualOutVal	
1028	0x0404	Loop.2.Main.ActiveOut	
1029	0x0405	Loop.2.Main.WorkingSP	
1030	0x0406	Loop.2.PID.ProportionalBand	
1031	0x0407	Loop.2.Setup.ControlAction	0 reverse; 1 direct
1032	0x0408	Loop.2.PID.IntegralTime	0 off
1033	0x0409	Loop.2.PID.DerivativeTime	0 off
1035	0x040b	Loop.2.SP.RangeLow	
1036	0x040c	Loop.2.SP.RangeHigh	
1039	0x040f	Loop.2.SP.SPSelect	0 SP1; 1 SP2
1040	0x0410	Loop.2.OP.Ch2Deadband	0 off
1041	0x0411	Loop.2.PID.CutbackLow	0 auto
1042	0x0412	Loop.2.PID.CutbackHigh	0 auto
1043	0x0413	Loop.2.PID.RelCh2Gain	
1045	0x0415	Loop.2.OP.Ch1TravelTime	
1048	0x0418	Loop.2.SP.SP1	
1049	0x0419	Loop.2.SP.SP2	
1051	0x041b	Loop.2.SP.SPTrim	
1052	0x041c	Loop.2.PID.ManualReset	
1054	0x041e	Loop.2.OP.OutputHighLimit	
1055	0x041f	Loop.2.OP.OutputLowLimit	

MODBUS	MODBUS (Hex)	Parameter	Enumerations
1058	0x0422	Loop.2.OP.SafeOutVal	
1059	0x0423	Loop.2.SP.Rate	
1061	0x0425	Loop.2.OP.Rate	
1063	0x0427	Loop.2.Diag.Error	
1070	0x042e	Loop.2.OP.PotCalibrate	0 off; 1 channel; 2 channel 2
1072	0x0430	Loop.2.PID.ProportionalBand2	
1073	0x0431	Loop.2.PID.IntegralTime2	0 off
1074	0x0432	Loop.2.PID.ManualReset2	0 auto
1075	0x0433	Loop.2.PID.DerivativeTime2	0 off
1076	0x0434	Loop.2.PID.RelCh2Gain2	
1077	0x0435	Loop.2.OP.Ch1PotPosition	
1079	0x0437	Loop.2.Diag.IntegralOutContrib	
1090	0x0442	Loop.2.SP.SPTrimHighLimit	
1091	0x0443	Loop.2.SP.SPTrimLowLimit	
1096	0x0448	Loop.2.PID.ActiveSet	1 set 1; 2 set 2; 3 set 3; 4 set 4; 5 set 5; 6 set 6
1102	0x044e	Loop.2.SP.RateDisable	0 no; 1 yes
1107	0x0453	Loop.2.PID.LoopBreakTime	0 off
1108	0x0454	Loop.2.OP.ManualOutVal	
1109	0x0455	Loop.2.OP.Ch1Out	
1110	0x0456	Loop.2.OP.Ch1OnOffHysteresis	
1112	0x0458	Loop.2.OP.Ch2OnOffHysteresis	
1121	0x0461	Loop.2.OP.FeedForwardGain	
1122	0x0462	Loop.2.OP.FeedForwardOffset	
1123	0x0463	Loop.2.OP.FeedForwardTrimLimit	
1135	0x046f	Loop.2.SP.SPHighLimit	
1136	0x0470	Loop.2.SP.SPLowLimit	
1140	0x0474	Loop.2.Diag.DerivativeOutContrib	
1141	0x0475	Loop.2.PID.CutbackLow2	0 auto
1142	0x0476	Loop.2.PID.CutbackHigh2	0 auto
1150	0x047e	Loop.2.OP.Ch2Out	
1151	0x047f	Loop.2.OP.TrackEnable	0 auto
1152	0x0480	Loop.2.OP.TrackOutVal	
1176	0x0498	Loop.2.PID.Boundary2-3	
1177	0x0499	Loop.2.PID.Boundary1-2	
1179	0x049b	Loop.2.SP.SPHighLimit	
1180	0x049c	Loop.2.SP.SPLowLimit	
1204	0x04b4	Loop.2.PID.ProportionalBand3	
1205	0x04b5	Loop.2.PID.IntegralTime3	0 off
1206	0x04b6	Loop.2.PID.ManualReset3	
1207	0x04b7	Loop.2.PID.DerivativeTime3	0 off
1208	0x04b8	Loop.2.PID.RelCh2Gain3	
1209	0x04b9	Loop.2.PID.ActiveSet	
1233	0x04d1	Loop.2.OP.FeedForwardVal	
1234	0x04d2	Loop.2.OP.PotCalibrate	
1238	0x04d6	Loop.2.Diag.PropOutContrib	
1254	0x04e6	Loop.2.SP.SPTrim	
1282	0x0502	Loop.2.Diag.SBrk	0 off; 1 on
1287	0x0507	Loop.2.Diag.LoopBreakAlarm	0 no; 1 yes
1292	0x050c	Loop.2.Main.Inhibit	0 no; 1 yes
1293	0x050d	Loop.2.Tune.Stage	0 reset; 1 none; 2 monitor; 3 currentSP; 4 NewSP; 5 ToSP; 6 max; 7 min; 8 store; 9 coolT; 10 PID; 11 abort; 12 complete
1294	0x050e	Loop.2.Tune.AutotuneEnable	0 off 1 on
1297	0x0511	Loop.2.Main.AutoMan	0 auto; 1 man
1300	0x0514	Loop.2.SP.AltSPSelect	0 no; 1 yes
1301	0x0515	Loop.2.SP.RateDone	0 no; 1 yes
1313	0x0521	Loop.2.Main.PV	
1341	0x053d	Loop.2.OP.Ch1PotPosition	
1342	0x053e	Loop.2.OP.Ch2PotPosition	
1343	0x053f	Loop.2.OP.Ch2TravelTime	



MODBUS	MODBUS (Hex)	Parameter	Enumerations
1374	0x055e	Loop.2.OP.Ch1PotBreak	0 off; 1 on
1509	0x05e5	Loop.2.SP.AltSP	
1536	0x0600	Loop.2.Setup.CH1ControlType	0 off; 1 on/off; 2 PID; 3 VPU; 4 VPB
1537	0x0601	Loop.2.Setup.CH2ControlType	0 off; 1 on/off; 2 PID; 3 VPU; 4 VPB
1548	0x060c	Loop.2.OP.CoolType	0 Linear; 1 Oil; 2 Water; 3 Fan
1550	0x060e	Loop.2.SP.SPTrack	0 off; 1 on
1551	0x060f	Loop.2.SP.ManualTrack	0 off; 1 on
1552	0x0610	Loop.2.SP.SPTrack	0 off; 1 on
1556	0x0614	Loop.2.OP.FeedForwardType	0 no; 1 remote; 2 SP; 3 PV
1574	0x0626	Loop.2.Setup.DerivativeType	0 PV; 1 error
1577	0x0629	Loop.2.OP.SensorBreakMode	0 SbrkOP; 1 hold
1580	0x062c	Loop.2.OP.ManualMode	0 track; 1 step; 3 lastMOP
1589	0x0635	Loop.2.OP.EnablePowerFeedforward	0 track; 1 step; 3 lastMOP
4750	0x128e	Math2.1.In1	
4751	0x128f	Math2.1.In2	
4752	0x1290	Math2.1.Out	
4753	0x1291	Math2.2.In1	
4754	0x1292	Math2.2.In2	
4755	0x1293	Math2.2.Out	
4756	0x1294	Math2.3.In1	
4757	0x1295	Math2.3.In2	
4758	0x1296	Math2.3.Out	
4759	0x1297	Math2.4.In1	
4760	0x1298	Math2.4.In2	
4761	0x1299	Math2.4.Out	
4762	0x129a	Math2.5.In1	
4763	0x129b	Math2.5.In2	
4764	0x129c	Math2.5.Out	
4765	0x129d	Math2.6.In1	
4766	0x129e	Math2.6.In2	
4767	0x129f	Math2.6.Out	
4768	0x12a0	Math2.7.In1	
4769	0x12a1	Math2.7.In2	
4770	0x12a2	Math2.7.Out	
4771	0x12a3	Math2.8.In1	
4772	0x12a4	Math2.8.In2	
4773	0x12a5	Math2.8.Out	
4774	0x12a6	Math2.9.In1	
4775	0x12a7	Math2.9.In2	
4776	0x12a8	Math2.9.Out	
4777	0x12a9	Math2.10.In1	
4778	0x12aa	Math2.10.In2	
4779	0x12ab	Math2.10.Out	
4780	0x12ac	Math2.11.In1	
4781	0x12ad	Math2.11.In2	
4782	0x12ae	Math2.11.Out	
4783	0x12af	Math2.12.In1	
4784	0x12b0	Math2.12.In2	
4785	0x12b1	Math2.12.Out	
4786	0x12b2	Math2.13.In1	
4787	0x12b3	Math2.13.In2	
4788	0x12b4	Math2.13.Out	
4789	0x12b5	Math2.14.In1	
4790	0x12b6	Math2.14.In2	
4791	0x12b7	Math2.14.Out	
4792	0x12b8	Math2.15.In1	
4793	0x12b9	Math2.15.In2	
4794	0x12ba	Math2.15.Out	
4795	0x12bb	Math2.16.In1	
4796	0x12bc	Math2.16.In2	

MODBUS	MODBUS (Hex)	Parameter	Enumerations
4797	0x12bd	Math2.16.Out	
4798	0x12be	Math2.17.In1	
4799	0x12bf	Math2.17.In2	
4800	0x12c0	Math2.17.Out	
4801	0x12c1	Math2.18.In1	
4802	0x12c2	Math2.18.In2	
4803	0x12c3	Math2.18.Out	
4804	0x12c4	Math2.19.In1	
4805	0x12c5	Math2.19.In2	
4806	0x12c6	Math2.19.Out	
4807	0x12c7	Math2.20.In1	
4808	0x12c8	Math2.20.In2	
4809	0x12c9	Math2.20.Out	
4810	0x12ca	Math2.21.In1	
4811	0x12cb	Math2.21.In2	
4812	0x12cc	Math2.21.Out	
4813	0x12cd	Math2.22.In1	
4814	0x12ce	Math2.22.In2	
4815	0x12cf	Math2.22.Out	
4816	0x12d0	Math2.23.In1	
4817	0x12d1	Math2.23.In2	
4818	0x12d2	Math2.23.Out	
4819	0x12d3	Math2.24.In1	
4820	0x12d4	Math2.24.In2	
4821	0x12d5	Math2.24.Out	
4822	0x12d6	Lgc2.1.In1	
4823	0x12d7	Lgc2.1.In2	
4824	0x12d8	Lgc2.1.Out	0 off; 1 on
4825	0x12d9	Lgc2.2.In1	
4826	0x12da	Lgc2.2.In2	
4827	0x12db	Lgc2.2.Out	0 off; 1 on
4828	0x12dc	Lgc2.3.In1	
4829	0x12dd	Lgc2.3.In2	
4830	0x12de	Lgc2.3.Out	0 off; 1 on
4831	0x12df	Lgc2.4.In1	
4832	0x12e0	Lgc2.4.In2	
4833	0x12e1	Lgc2.4.Out	0 off; 1 on
4834	0x12e2	Lgc2.5.In1	
4835	0x12e3	Lgc2.5.In2	
4836	0x12e4	Lgc2.5.Out	0 off; 1 on
4837	0x12e5	Lgc2.6.In1	
4838	0x12e6	Lgc2.6.In2	
4839	0x12e7	Lgc2.6.Out	0 off; 1 on
4840	0x12e8	Lgc2.7.In1	
4841	0x12e9	Lgc2.7.In2	
4842	0x12ea	Lgc2.7.Out	0 off; 1 on
4843	0x12eb	Lgc2.8.In1	
4844	0x12ec	Lgc2.8.In2	
4845	0x12ed	Lgc2.8.Out	0 off; 1 on
4846	0x12ee	Lgc2.9.In1	
4847	0x12ef	Lgc2.9.In2	
4848	0x12f0	Lgc2.9.Out	0 off; 1 on
4849	0x12f1	Lgc2.10.In1	
4850	0x12f2	Lgc2.10.In2	
4851	0x12f3	Lgc2.10.Out	0 off; 1 on
4852	0x12f4	Lgc2.11.In1	
4853	0x12f5	Lgc2.11.In2	
4854	0x12f6	Lgc2.11.Out	0 off; 1 on
4855	0x12f7	Lgc2.12.In1	
4856	0x12f8	Lgc2.12.In2	

MODBUS	MODBUS (Hex)	Parameter	Enumerations
4857	0x12f9	Lgc2.12.Out	0 off; 1 on
4858	0x12fa	Lgc2.13.In1	
4859	0x12fb	Lgc2.13.In2	
4860	0x12fc	Lgc2.13.Out	0 off; 1 on
4861	0x12fd	Lgc2.14.In1	
4862	0x12fe	Lgc2.14.In2	
4863	0x12ff	Lgc2.14.Out	0 off; 1 on
4864	0x1300	Lgc2.15.In1	
4865	0x1301	Lgc2.15.In2	
4866	0x1302	Lgc2.15.Out	0 off; 1 on
4867	0x1303	Lgc2.16.In1	
4868	0x1304	Lgc2.16.In2	
4869	0x1305	Lgc2.16.Out	0 off; 1 on
4870	0x1306	Lgc2.17.In1	
4871	0x1307	Lgc2.17.In2	
4872	0x1308	Lgc2.17.Out	0 off; 1 on
4873	0x1309	Lgc2.18.In1	
4874	0x130a	Lgc2.18.In2	
4875	0x130b	Lgc2.18.Out	0 off; 1 on
4876	0x130c	Lgc2.19.In1	
4877	0x130d	Lgc2.19.In2	
4878	0x130e	Lgc2.19.Out	0 off; 1 on
4879	0x130f	Lgc2.20.In1	
4880	0x1310	Lgc2.20.In2	
4881	0x1311	Lgc2.20.Out	0 off; 1 on
4882	0x1312	Lgc2.21.In1	
4883	0x1313	Lgc2.21.In2	
4884	0x1314	Lgc2.21.Out	0 off; 1 on
4885	0x1315	Lgc2.22.In1	
4886	0x1316	Lgc2.22.In2	
4887	0x1317	Lgc2.22.Out	0 off; 1 on
4888	0x1318	Lgc2.23.In1	
4889	0x1319	Lgc2.23.In2	
4890	0x131a	Lgc2.23.Out	0 off; 1 on
4891	0x131b	Lgc2.24.In1	
4892	0x131c	Lgc2.24.In2	
4893	0x131d	Lgc2.24.Out	0 off; 1 on
4894	0x131e	Lgc8.1.In1	0 off; 1 on
4895	0x131f	Lgc8.1.In2	0 off; 1 on
4896	0x1320	Lgc8.1.In3	0 off; 1 on
4897	0x1321	Lgc8.1.In4	0 off; 1 on
4898	0x1322	Lgc8.1.In5	0 off; 1 on
4899	0x1323	Lgc8.1.In6	0 off; 1 on
4900	0x1324	Lgc8.1.In7	0 off; 1 on
4901	0x1325	Lgc8.1.In8	0 off; 1 on
4902	0x1326	Lgc8.1.Out	0 off; 1 on
4903	0x1327	Lgc8.2.In1	0 off; 1 on
4904	0x1328	Lgc8.2.In2	0 off; 1 on
4905	0x1329	Lgc8.2.In3	0 off; 1 on
4906	0x132a	Lgc8.2.In4	0 off; 1 on
4907	0x132b	Lgc8.2.In5	0 off; 1 on
4908	0x132c	Lgc8.2.In6	0 off; 1 on
4909	0x132d	Lgc8.2.In7	0 off; 1 on
4910	0x132e	Lgc8.2.In8	0 off; 1 on
4911	0x132f	Lgc8.2.Out	0 off; 1 on
4915	0x1333	IPMonitor.1.Max	
4916	0x1334	IPMonitor.1.Min	
4917	0x1335	IPMonitor.1.Threshold	
4918	0x1336	IPMonitor.1.TimeAbove	
4919	0x1337	IPMonitor.1.Reset	

MODBUS	MODBUS (Hex)	Parameter	Enumerations
4920	0x1338	IPMonitor.2.Max	
4921	0x1339	IPMonitor.2.Min	
4922	0x133a	IPMonitor.2.Threshold	
4923	0x133b	IPMonitor.2.TimeAbove	
4924	0x133c	IPMonitor.2.Reset	
4925	0x133d	SwitchOver.SwitchHigh	
4926	0x133e	SwitchOver.SwitchLow	
4927	0x133f	SwitchOver.SelectIn	
4962	0x1362	UsrVal.1.Val	
4963	0x1363	UsrVal.2.Val	
4964	0x1364	UsrVal.3.Val	
4965	0x1365	UsrVal.4.Val	
4966	0x1366	UsrVal.5.Val	
4967	0x1367	UsrVal.6.Val	
4968	0x1368	UsrVal.7.Val	
4969	0x1369	UsrVal.8.Val	
4970	0x136a	UsrVal.9.Val	
4971	0x136b	UsrVal.10.Val	
4972	0x136c	UsrVal.11.Val	
4973	0x136d	UsrVal.12.Val	
4974	0x136e	UsrVal.13.Val	
4975	0x136f	UsrVal.14.Val	
4976	0x1370	UsrVal.15.Val	
4977	0x1371	UsrVal.16.Val	
4994	0x1382	Timer.1.Time	
4995	0x1383	Timer.1.ElapsedTime	
4996	0x1384	Timer.1.Out	0 off; 1 On
4997	0x1385	Timer.2.Time	
4998	0x1386	Timer.2.ElapsedTime	
4999	0x1387	Timer.2.Out	0 off; 1 On
5000	0x1388	Timer.3.Time	
5001	0x1389	Timer.3.ElapsedTime	
5002	0x138A	Timer.3.Out	0 off; 1 On
5003	0x138B	Timer.4.Time	
5004	0x138C	Timer.4.ElapsedTime	
5005	0x138D	Timer.4.Out	0 off; 1 On
5006	0x138e	MultiOper.1.In1	
5007	0x138f	MultiOper.1.In2	
5008	0x1390	MultiOper.1.In3	
5009	0x1391	MultiOper.1.In4	
5010	0x1392	MultiOper.1.In5	
5011	0x1393	MultiOper.1.In6	
5012	0x1394	MultiOper.1.In7	
5013	0x1395	MultiOper.1.In8	
5014	0x1396	MultiOper.1.SumOut	
5015	0x1397	MultiOper.1.MaxOut	
5016	0x1398	MultiOper.1.MinOut	
5017	0x1399	MultiOper.1.AverageOut	
5018	0x139a	MultiOper.2.In1	
5019	0x139b	MultiOper.2.In2	
5020	0x139c	MultiOper.2.In3	
5021	0x139d	MultiOper.2.In4	
5022	0x139e	MultiOper.2.In5	
5023	0x139f	MultiOper.2.In6	
5024	0x13a0	MultiOper.2.In7	
5025	0x13a1	MultiOper.2.In8	
5026	0x13a2	MultiOper.2.SumOut	
5027	0x13a3	MultiOper.2.MaxOut	
5028	0x13a4	MultiOper.2.MinOut	
5029	0x13a5	MultiOper.2.AverageOut	

MODBUS	MODBUS (Hex)	Parameter	Enumerations
8192	0x2000	Comms.ProgNum	
10176	0x27c0	AlmSummary.AnAlarmByte	
10188	0x27cc	AlmSummary.DigAlarmByte	
10200	0x27d8	AlmSummary.SBrkAlarm	
10240	0x2800	Alarm.1.Type	0 None; 1 Abs High' 2 Abs Low; 3 Dev High; 4 Dev low; 5 Dev Band; 6 Rising rate of change; 7 Falling rate of change
10241	0x2801	Alarm.1.Threshold	
10242	0x2802	Alarm.1.Hysteresis	
10243	0x2803	Alarm.1.Reference	
10244	0x2804	Alarm.1.Latch	0 none; 1 Auto; 2 Manual; 3 Event
10245	0x2805	Alarm.1.Priority	0 Low; 2 Medium; 3 High
10246	0x2806	Alarm.1.Block	0 No; 1 Yes
10247	0x2807	Alarm.1.Inhibit	0 No; 1 Yes
10248	0x2808	Alarm.1.Delay	
10249	0x2809	Alarm.1.Out	0 Off; 1 On
10250	0x280a	Alarm.1.Ack	0 No; 1 Yes
10256	0x2810	Alarm.2.Type	0 None; 1 Abs High' 2 Abs Low; 3 Dev High; 4 Dev low; 5 Dev Band; 6 Rising rate of change; 7 Falling rate of change
10257	0x2811	Alarm.2.Threshold	
10258	0x2812	Alarm.2.Hysteresis	
10259	0x2813	Alarm.2.Reference	
10260	0x2814	Alarm.2.Latch	0 none; 1 Auto; 2 Manual; 3 Event
10261	0x2815	Alarm.2.Priority	0 Low; 2 Medium; 3 High
10262	0x2816	Alarm.2.Block	0 No; 1 Yes
10263	0x2817	Alarm.2.Inhibit	0 No; 1 Yes
10264	0x2818	Alarm.2.Delay	
10265	0x2819	Alarm.2.Out	0 Off; 1 On
10266	0x281a	Alarm.2.Ack	0 No; 1 Yes
10272	0x2820	Alarm.3.Type	0 None; 1 Abs High' 2 Abs Low; 3 Dev High; 4 Dev low; 5 Dev Band; 6 Rising rate of change; 7 Falling rate of change
10273	0x2821	Alarm.3.Threshold	
10274	0x2822	Alarm.3.Hysteresis	
10275	0x2823	Alarm.3.Reference	
10276	0x2824	Alarm.3.Latch	0 none; 1 Auto; 2 Manual; 3 Event
10277	0x2825	Alarm.3.Priority	0 Low; 2 Medium; 3 High
10278	0x2826	Alarm.3.Block	0 No; 1 Yes
10279	0x2827	Alarm.3.Inhibit	0 No; 1 Yes
10280	0x2828	Alarm.3.Delay	
10281	0x2829	Alarm.3.Out	0 Off; 1 On
10282	0x282a	Alarm.3.Ack	0 No; 1 Yes
10288	0x2830	Alarm.4.Type	0 None; 1 Abs High' 2 Abs Low; 3 Dev High; 4 Dev low; 5 Dev Band; 6 Rising rate of change; 7 Falling rate of change
10289	0x2831	Alarm.4.Threshold	
10290	0x2832	Alarm.4.Hysteresis	
10291	0x2833	Alarm.4.Reference	
10292	0x2834	Alarm.4.Latch	0 none; 1 Auto; 2 Manual; 3 Event
10293	0x2835	Alarm.4.Priority	0 Low; 2 Medium; 3 High
10294	0x2836	Alarm.4.Block	0 No; 1 Yes
10295	0x2837	Alarm.4.Inhibit	0 No; 1 Yes
10296	0x2838	Alarm.4.Delay	
10297	0x2839	Alarm.4.Out	0 Off; 1 On
10298	0x283a	Alarm.4.Ack	0 No; 1 Yes
10304	0x2840	Alarm.5.Type	0 None; 1 Abs High' 2 Abs Low; 3 Dev High; 4 Dev low; 5 Dev Band; 6 Rising rate of change; 7 Falling rate of change
10305	0x2841	Alarm.5.Threshold	
10306	0x2842	Alarm.5.Hysteresis	
10307	0x2843	Alarm.5.Reference	

MODBUS	MODBUS (Hex)	Parameter	Enumerations
10308	0x2844	Alarm.5.Latch	0 none; 1 Auto; 2 Manual; 3 Event
10309	0x2845	Alarm.5.Priority	0 Low; 2 Medium; 3 High
10310	0x2846	Alarm.5.Block	0 No; 1 Yes
10311	0x2847	Alarm.5.Inhibit	0 No; 1 Yes
10312	0x2848	Alarm.5.Delay	
10313	0x2849	Alarm.5.Out	0 Off; 1 On
10314	0x284a	Alarm.5.Ack	0 No; 1 Yes
10320	0x2850	Alarm.6.Type	0 None; 1 Abs High' 2 Abs Low; 3 Dev High; 4 Dev low; 5 Dev Band; 6 Rising rate of change; 7 Falling rate of change
10321	0x2851	Alarm.6.Threshold	
10322	0x2852	Alarm.6.Hysteresis	
10323	0x2853	Alarm.6.Reference	
10324	0x2854	Alarm.6.Latch	0 none; 1 Auto; 2 Manual; 3 Event
10325	0x2855	Alarm.6.Priority	0 Low; 2 Medium; 3 High
10326	0x2856	Alarm.6.Block	0 No; 1 Yes
10327	0x2857	Alarm.6.Inhibit	0 No; 1 Yes
10328	0x2858	Alarm.6.Delay	
10329	0x2859	Alarm.6.Out	0 Off; 1 On
10330	0x285a	Alarm.6.Ack	0 No; 1 Yes
10336	0x2860	Alarm.7.Type	0 None; 1 Abs High' 2 Abs Low; 3 Dev High; 4 Dev low; 5 Dev Band; 6 Rising rate of change; 7 Falling rate of change
10337	0x2861	Alarm.7.Threshold	
10338	0x2862	Alarm.7.Hysteresis	
10339	0x2863	Alarm.7.Reference	
10340	0x2864	Alarm.7.Latch	0 none; 1 Auto; 2 Manual; 3 Event
10341	0x2865	Alarm.7.Priority	0 Low; 2 Medium; 3 High
10342	0x2866	Alarm.7.Block	0 No; 1 Yes
10343	0x2867	Alarm.7.Inhibit	0 No; 1 Yes
10344	0x2868	Alarm.7.Delay	
10345	0x2869	Alarm.7.Out	0 Off; 1 On
10346	0x286a	Alarm.7.Ack	0 No; 1 Yes
10352	0x2870	Alarm.8.Type	0 None; 1 Abs High' 2 Abs Low; 3 Dev High; 4 Dev low; 5 Dev Band; 6 Rising rate of change; 7 Falling rate of change
10353	0x2871	Alarm.8.Threshold	
10354	0x2872	Alarm.8.Hysteresis	
10355	0x2873	Alarm.8.Reference	
10356	0x2874	Alarm.8.Latch	0 none; 1 Auto; 2 Manual; 3 Event
10357	0x2875	Alarm.8.Priority	0 Low; 2 Medium; 3 High
10358	0x2876	Alarm.8.Block	0 No; 1 Yes
10359	0x2877	Alarm.8.Inhibit	0 No; 1 Yes
10360	0x2878	Alarm.8.Delay	
10361	0x2879	Alarm.8.Out	0 Off; 1 On
10362	0x287a	Alarm.8.Ack	0 No; 1 Yes
11264	0x2c00	DigAlarm.1.Type	8 None; 9 Positive edge; 10 Negative edge; 11 Edge triggered; 12 High; 13 Low
11268	0x2c04	DigAlarm.1.Latch	0 none; 1 Auto; 2 Manual; 3 Event
11269	0x2c05	DigAlarm.1.Priority	0 Low; 2 Medium; 3 High
11270	0x2c06	DigAlarm.1.Block	0 No; 1 Yes
11271	0x2c07	DigAlarm.1.Inhibit	0 No; 1 Yes
11272	0x2c08	DigAlarm.1.Delay	
11273	0x2c09	DigAlarm.1.Out	0 Off; 1 On
11274	0x2c0a	DigAlarm.1.Ack	0 No; 1 Yes
11280	0x2c10	DigAlarm.2.Type	8 None; 9 Positive edge; 10 Negative edge; 11 Edge triggered; 12 High; 13 Low
11284	0x2c14	DigAlarm.2.Latch	0 none; 1 Auto; 2 Manual; 3 Event
11285	0x2c15	DigAlarm.2.Priority	0 Low; 2 Medium; 3 High
11286	0x2c16	DigAlarm.2.Block	0 No; 1 Yes
11287	0x2c17	DigAlarm.2.Inhibit	0 No; 1 Yes
11288	0x2c18	DigAlarm.2.Delay	

MODBUS	MODBUS (Hex)	Parameter	Enumerations
11289	0x2c19	DigAlarm.2.Out	0 Off; 1 On
11290	0x2c1a	DigAlarm.2.Ack	0 No; 1 Yes
11296	0x2c20	DigAlarm.3.Type	8 None; 9 Positive edge; 10 Negative edge; 11 Edge triggered; 12 High; 13 Low
11300	0x2c24	DigAlarm.3.Latch	0 none; 1 Auto; 2 Manual; 3 Event
11301	0x2c25	DigAlarm.3.Priority	0 Low; 2 Medium; 3 High
11302	0x2c26	DigAlarm.3.Block	0 No; 1 Yes
11303	0x2c27	DigAlarm.3.Inhibit	0 No; 1 Yes
11304	0x2c28	DigAlarm.3.Delay	
11305	0x2c29	DigAlarm.3.Out	0 Off; 1 On
11306	0x2c2a	DigAlarm.3.Ack	0 No; 1 Yes
11312	0x2c30	DigAlarm.4.Type	8 None; 9 Positive edge; 10 Negative edge; 11 Edge triggered; 12 High; 13 Low
11316	0x2c34	DigAlarm.4.Latch	0 none; 1 Auto; 2 Manual; 3 Event
11317	0x2c35	DigAlarm.4.Priority	0 Low; 2 Medium; 3 High
11318	0x2c36	DigAlarm.4.Block	0 No; 1 Yes
11319	0x2c37	DigAlarm.4.Inhibit	0 No; 1 Yes
11320	0x2c38	DigAlarm.4.Delay	
11321	0x2c39	DigAlarm.4.Out	0 Off; 1 On
11322	0x2c3a	DigAlarm.4.Ack	0 No; 1 Yes
11328	0x2c40	DigAlarm.5.Type	8 None; 9 Positive edge; 10 Negative edge; 11 Edge triggered; 12 High; 13 Low
11332	0x2c44	DigAlarm.5.Latch	0 none; 1 Auto; 2 Manual; 3 Event
11333	0x2c45	DigAlarm.5.Priority	0 Low; 2 Medium; 3 High
11334	0x2c46	DigAlarm.5.Block	0 No; 1 Yes
11335	0x2c47	DigAlarm.5.Inhibit	0 No; 1 Yes
11336	0x2c48	DigAlarm.5.Delay	
11337	0x2c49	DigAlarm.5.Out	0 Off; 1 On
11338	0x2c4a	DigAlarm.5.Ack	0 No; 1 Yes
11344	0x2c50	DigAlarm.6.Type	8 None; 9 Positive edge; 10 Negative edge; 11 Edge triggered; 12 High; 13 Low
11348	0x2c54	DigAlarm.6.Latch	0 none; 1 Auto; 2 Manual; 3 Event
11349	0x2c55	DigAlarm.6.Priority	0 Low; 2 Medium; 3 High
11350	0x2c56	DigAlarm.6.Block	0 No; 1 Yes
11351	0x2c57	DigAlarm.6.Inhibit	0 No; 1 Yes
11352	0x2c58	DigAlarm.6.Delay	
11353	0x2c59	DigAlarm.6.Out	0 Off; 1 On
11354	0x2c5a	DigAlarm.6.Ack	0 No; 1 Yes
11360	0x2c60	DigAlarm.7.Type	8 None; 9 Positive edge; 10 Negative edge; 11 Edge triggered; 12 High; 13 Low
11364	0x2c64	DigAlarm.7.Latch	0 none; 1 Auto; 2 Manual; 3 Event
11365	0x2c65	DigAlarm.7.Priority	0 Low; 2 Medium; 3 High
11366	0x2c66	DigAlarm.7.Block	0 No; 1 Yes
11367	0x2c67	DigAlarm.7.Inhibit	0 No; 1 Yes
11368	0x2c68	DigAlarm.7.Delay	
11369	0x2c69	DigAlarm.7.Out	0 Off; 1 On
11370	0x2c6a	DigAlarm.7.Ack	0 No; 1 Yes
11376	0x2c70	DigAlarm.8.Type	8 None; 9 Positive edge; 10 Negative edge; 11 Edge triggered; 12 High; 13 Low
11380	0x2c74	DigAlarm.8.Latch	0 none; 1 Auto; 2 Manual; 3 Event
11381	0x2c75	DigAlarm.8.Priority	0 Low; 2 Medium; 3 High
11382	0x2c76	DigAlarm.8.Block	0 No; 1 Yes
11383	0x2c77	DigAlarm.8.Inhibit	0 No; 1 Yes
11384	0x2c78	DigAlarm.8.Delay	
11385	0x2c79	DigAlarm.8.Out	0 Off; 1 On
11386	0x2c7a	DigAlarm.8.Ack	0 No; 1 Yes
12707	0x31a3	ModIDs.Mod1Ident	0 triple logic IP; 7 triple logic OP; 8 transmitter PSU; 14; transducer PSU; 20 tri-contact IP; 21 single logic; 24 pot IP; 32 dual relay; 35 dual triac; 40 changeover relay; 48 relay; 49 triac; 56 no module; 63 bad ident; 242 dc OP; 243 dc retrans; 249 invalid; 250

MODBUS	MODBUS (Hex)	Parameter	Enumerations
			analogue IP; 251 dual dc OP; 252 HRDCOut
12771	0x31e3	ModIDs.Mod2Ident	0 triple logic IP; 7 triple logic OP; 8 transmitter PSU; 14; transducer PSU; 20 tri-contact IP; 21 single logic; 24 pot IP; 32 dual relay; 35 dual triac; 40 changeover relay; 48 relay; 49 triac; 56 no module; 63 bad ident; 242 dc OP; 243 dc retrans; 249 invalid; 250 analogue IP; 251 dual dc OP; 252 HRDCOut
12835	0x3223	ModIDs.Mod3Ident	0 triple logic IP; 7 triple logic OP; 8 transmitter PSU; 14; transducer PSU; 20 tri-contact IP; 21 single logic; 24 pot IP; 32 dual relay; 35 dual triac; 40 changeover relay; 48 relay; 49 triac; 56 no module; 63 bad ident; 242 dc OP; 243 dc retrans; 249 invalid; 250 analogue IP; 251 dual dc OP; 252 HRDCOut
12899	0x3263	ModIDs.Mod4Ident	0 triple logic IP; 7 triple logic OP; 8 transmitter PSU; 14; transducer PSU; 20 tri-contact IP; 21 single logic; 24 pot IP; 32 dual relay; 35 dual triac; 40 changeover relay; 48 relay; 49 triac; 56 no module; 63 bad ident; 242 dc OP; 243 dc retrans; 249 invalid; 250 analogue IP; 251 dual dc OP; 252 HRDCOut
12963	0x32a3	ModIDs.Mod5Ident	0 triple logic IP; 7 triple logic OP; 8 transmitter PSU; 14; transducer PSU; 20 tri-contact IP; 21 single logic; 24 pot IP; 32 dual relay; 35 dual triac; 40 changeover relay; 48 relay; 49 triac; 56 no module; 63 bad ident; 242 dc OP; 243 dc retrans; 249 invalid; 250 analogue IP; 251 dual dc OP; 252 HRDCOut
13027	0x32e3	ModIDs.Mod6Ident	0 triple logic IP; 7 triple logic OP; 8 transmitter PSU; 14; transducer PSU; 20 tri-contact IP; 21 single logic; 24 pot IP; 32 dual relay; 35 dual triac; 40 changeover relay; 48 relay; 49 triac; 56 no module; 63 bad ident; 242 dc OP; 243 dc retrans; 249 invalid; 250 analogue IP; 251 dual dc OP; 252 HRDCOut
13248	0x33CO	Zirconia.1.CleanProbe	0 No; 1 Yes
13249	0x33C1	Zirconia.1.Time2Clean	
13250	0x33C2	Zirconia.1.ProbeOffset	
13251	0x33C3	Zirconia.1.CleanFreq	
13252	0x33C4	Zirconia.1.CleanTime	
13253	0x33C5	Zirconia.1.MaxRcovTime	
13254	0x33C6	Zirconia.1.GasRef	
13255	0x33C7	Zirconia.1.MinRcovTime	
13256	0x33C8	Zirconia.1.CarbonPot	
13257	0x33C9	Zirconia.1.RemGasEn	0 No; 1 Yes
13258	0x33CA	Zirconia.1.ProbeType	25; MMI; 26 AACC; 26 Drayton; 27 Accucarb; 29 SSI; 30 MacDhui; 31 Bosch; 32 BarberC; 33 Feranova; 34 ProbeMV; 35 Eurotherm
13259	0x33CB	Zirconia.1.ProbeInput	
13260	0x33CC	Zirconia.1.OxygenExp	
13261	0x33CD	Zirconia.1.Oxygen	
13262	0x33CE	Zirconia.1.ProbeStatus	0 OK; 1 mVSbr; 2 TempSbr; 3 MinCalcT
13263	0x33CF	Zirconia.1.CleanValve	0 No; 1 Yes
13264	0x33D0	Zirconia.1.SootAlm	0 No; 1 Yes
13265	0x33D1	Zirconia.1.WrkGas	
13266	0x33D2	Zirconia.1.TempOffset	
13267	0x33D3	Zirconia.1.RemGasRef	
13268	0x33D4	Zirconia.1.CleanState	0 waiting; 1 clean; 2 recovery
13269	0x33D5	Zirconia.1.TempInput	
13270	0x33D6	Zirconia.1.MinCalTemp	
13271	0x33D7	Zirconia.1.ProbeFault	0 No; 1 Yes
13272	0x33D8	Zirconia.1.PVFrozen	0 No; 1 Yes
13273	0x33D9	Zirconia.1.Resolution	0 X; 1 X.X; 2 X.XX; 3 X.XXX; 4 X.XXXX
13274	0x33DA	Zirconia.1.DewPoint	
13275	0x33DB	Zirconia.1.ProcFactor	



MODBUS	MODBUS (Hex)	Parameter	Enumerations
13276	0x33DC	Zirconia.1.Tolerance	
13312	0x3400	Humidity.WetOffset	
13313	0x3401	Humidity.Pressure	
13314	0x3402	Humidity.SBrk	0 No; 1 Yes
13315	0x3403	Humidity.PsychroConst	
13316	0x3404	Humidity.RelHumid	
13317	0x3405	Humidity.DewPoint	
13318	0x3406	Humidity.DryTemp	
13319	0x3407	Humidity.WetTemp	
13320	0x3408	Humidity.Resolution	0 X; 1 X.X; 2 X.XX; 3 X.XXX; 4 X.XXXX

### 30.4 Dual Programmers via SCADA Comms and Profibus Tag Addresses

It is possible to edit and run programs for either asynchronous or synchronous programmers using SCADA communications. As programs can be run by any programmer and segments are located in a free formatted pool, the SCADA addresses of Program/Segment parameters are dependent upon a number of factors and hence a set procedure must be followed.

These tables also show the Tag addresses for Profibus protocol.

#### 30.4.1 Parameter Tables

The following table lists the offsets for Programmer parameters that are available over SCADA comms – they also allow the Tag addresses to be calculated for Profibus:

Program General Data Table			
Offset	Parameter	Offset	Parameter
0	Comms.ProgramNumber	23	Programmer.SyncIn
1	Program.HoldbackVal	24	Programmer.FastRun
2	Program.RampUnits	25	Programmer.AdvSeg
3	Program.DwellUnits	26	Programmer.SkipSeg
4	Program.Cycles	27	Program.Ch2RampUnits
5	Programmer.PowerFailAct	28	Program.Ch2DwellUnits
6	Programmer.Servo	29	Program.PVStart
7	Programmer.SyncMode	30	Program.Ch2PVStart
8	Programmer.ResetEventOuts	31	Program.Ch2HoldbackVal
9	Programmer.CurProg	32	Program.Ch1HoldbackVal
10	Programmer.CurSeg	33	Program.Ch1RampUnits
11	Programmer.ProgStatus	34	Programmer.PrgIn1
12	Programmer.PSP	35	Programmer.PrgIn2
13	Programmer.CyclesLeft	36	Programmer.PVEventIP
14	Programmer.CurSegType	37	Programmer.ProgInvalid
15	Programmer.SegTarget	38	Programmer.PVEventOP
16	Programmer.SegRate	39	Programmer.GoBackCyclesLeft
17	Programmer.ProgTimeLeft	40	Programmer.DelayTime
18	Programmer.PVIn	41	Programmer.ProgReset
19	Programmer.SPIn	42	Programmer.ProgRun
20	Programmer.EventOuts	43	Programmer.ProgHold
21	Programmer.SegTimeLeft	44	Programmer.ProgRunHold
22	Programmer.EndOfSeg	45	Programmer.ProgRunReset

### 30.4.2 Example Programmer 1/2 Setup Parameters

The following table shows the Tag Addresses for Programmer 1 and Programmer 2 Setup and Run parameters, calculated by adding the offsets shown in the previous table to Programmer 1 Number (5184) and Programmer 2 Number (5248).

Program General Data Table			
Address	Parameter	Offset	Parameter
5184/5248	Programmer 1/2 Comms ProgramNumber	5207/5271	Programmer 1/2 Synchronise Input
5185/5249	Programmer 1/2 Holdback Value	5208/5272	Programmer 1/2 Fast Run
5186/5250	Programmer 1/2 Ramp Units	5209/5273	Programmer 1/2 Advance Segment
5187/5251	Programmer 1/2 Dwell Units	5210/5274	Programmer 1/2 Skip Segment
5188/5252	Programmer 1/2 Number of Cycles	5211/5275	Programmer 1/2 Ch2 Ramp Units
5189/5253	Programmer 1/2 Action on Power Fail	5212/5276	Programmer 1/2 Ch2 Dwell Units
5190/5254	Programmer 1/2 Servo Action	5213/5277	Programmer 1/2 PV Start
5191/5255	Programmer 1/2 Synchronisation Mode	5214/5278	Programmer 1/2 Ch2 PV Start
5192/5256	Programmer 1/2 Reset Event Outputs	5215/5279	Programmer 1/2 Ch2 Holdback Value
5193/5257	Programmer 1/2 Current Program Number	5216/5280	Programmer 1/2 Ch1 Holdback Value
5194/5258	Programmer 1/2 Current Running Segment	5217/5281	Programmer 1/2 Ch1 Ramp Units
5195/5259	Programmer 1/2 Program Status	5218/5282	Programmer 1/2 Digital Input 1
5196/5260	Programmer 1/2 Setpoint	5219/5283	Programmer 1/2 Digital Input 2
5197/5261	Programmer 1/2 Number of CyclesLeft	5220/5284	Programmer 1/2 PV Wait Input
5198/5262	Programmer 1/2 Current Segment Type	5221/5285	Programmer 1/2 Program Error
5199/5263	Programmer 1/2 Current Target SP Value	5222/5286	Programmer 1/2 PV Event Output
5200/5264	Programmer 1/2 Segment Ramp Rate	5223/5287	Programmer 1/2 Number of Cycles Left
5201/5265	Programmer 1/2 Program Time Left	5224/5288	Programmer 1/2 Delayed Start
5202/5266	Programmer 1/2.PV Input	5225/5289	Programmer 1/2 Program Reset
5203/5267	Programmer 1/2 Setpoint Input	5226/5290	Programmer 1/2 Program Run
5204/5268	Programmer 1/2 Event Output 1	5227/5291	Programmer 1/2 Program Hold
5205/5269	Programmer 1/2 Segment Time Left	5228/5292	Programmer 1/2 Program Run Hold input
5206/5270	Programmer 1/2 End of Segment	5229/5293	Programmer 1/2 Program Run Reset Input

### 30.4.3 Programmer Segment Address Assignment

The following table shows the address ranges set aside for the Programmer segments:

Area		Start Address	Start Address hex
Programmer1	Program General Data	5184	0x1440
Programmer2	Program General Data	5248	0x1480
Reserved for future expansion: 5312 (0x14C0) – 5375 (0x14FF)			
Programmer1 (Sync Ch1)	Segment1	5376	0x1500
	Segment2	5408	0x1520
	Segment3	5440	0x1540
	Segment4	5472	0x1560
	Segment5	5504	0x1580
	Segment6	5536	0x15A0
	Segment7	5568	0x15C0
	Segment8	5600	0x15E0
	Segment9	5632	0x1600
	Segment10	5664	0x1620
	Segment11	5696	0x1640
	Segment12	5728	0x1660
	Segment13	5760	0x1680
	Segment14	5792	0x16A0
	Segment15	5824	0x16C0
	Segment16	5856	0x16E0
	Segment17	5888	0x1700
	Segment18	5920	0x1720
	Segment19	5952	0x1740
	Segment20	5984	0x1760
	Segment21	6016	0x1780
	Segment22	6048	0x17A0
	Segment23	6080	0x17C0
	Segment24	6112	0x17E0
	Segment25	6144	0x1800
Programmer1 (Sync Ch1)	Segment26	6176	0x1820
	Segment27	6208	0x1840
	Segment28	6240	0x1860
	Segment29	6272	0x1880
	Segment30	6304	0x18A0
	Segment31	6336	0x18C0
	Segment32	6368	0x18E0
	Segment33	6400	0x1900
	Segment34	6432	0x1920
	Segment35	6464	0x1940
	Segment36	6496	0x1960
	Segment37	6528	0x1980
	Segment38	6560	0x19A0
	Segment39	6592	0x19C0
	Segment40	6624	0x19E0
	Segment41	6656	0x1A00
	Segment42	6688	0x1A20
	Segment43	6720	0x1A40
	Segment44	6752	0x1A60
	Segment45	6784	0x1A80
	Segment46	6816	0x1AA0
	Segment47	6848	0x1AC0
	Segment48	6880	0x1AE0
	Segment49	6912	0x1B00
	Segment50	6944	0x1B20

Area		Start Address	Start Address hex
Programmer2 (Sync Ch2)	Segment1	6976	0x1B40
	Segment2	7008	0x1B60
	Segment3	7040	0x1B80
	Segment4	7072	0x1BA0
	Segment5	7104	0x1BC0
	Segment6	7136	0x1BE0
	Segment7	7168	0x1C00
	Segment8	7200	0x1C20
	Segment9	7232	0x1C40
	Segment10	7264	0x1C60
	Segment11	7296	0x1C80
	Segment12	7328	0x1CA0
	Segment13	7360	0x1CC0
	Segment14	7392	0x1CE0
	Segment15	7424	0x1D00
	Segment16	7456	0x1D20
	Segment17	7488	0x1D40
	Segment18	7520	0x1D60
Programmer2 (Sync Ch2)	Segment19	7552	0x1D80
	Segment20	7584	0x1DA0
	Segment21	7616	0x1DC0
	Segment22	7648	0x1DE0
	Segment23	7680	0x1E00
	Segment24	7712	0x1E20
	Segment25	7744	0x1E40
	Segment26	7776	0x1E60
	Segment27	7808	0x1E80
	Segment28	7840	0x1EA0
	Segment29	7872	0x1EC0
	Segment30	7904	0x1EE0
	Segment31	7936	0x1F00
	Segment32	7968	0x1F20
	Segment33	8000	0x1F40
	Segment34	8032	0x1F60
	Segment35	8064	0x1F80
	Segment36	8096	0x1FA0
	Segment37	8128	0x1FC0
	Segment38	8160	0x1FE0
	Segment39	8192	0x2000
	Segment40	8224	0x2020
	Segment41	8256	0x2040
	Segment42	8288	0x2060
	Segment43	8320	0x2080
	Segment44	8352	0x20A0
	Segment45	8384	0x20C0
	Segment46	8416	0x20E0
	Segment47	8448	0x2100
	Segment48	8480	0x2120
	Segment49	8512	0x2140
	Segment50	8544	0x2160
Reserved for future expansion: 8576 (0x2180) - 10175 (0x27BF)			

### 30.4.4 Parameters Available in Every Segment of a Programmer

The following table lists the offsets for Segment parameters that are available over SCADA comms:

Segment Data Table			
Offset	Parameter	Offset	Parameter
0	Segment.Type	12	Segment.GobackCycles
1	Segment.Holdback	13	Segment.PVEvent
2	Segment.CallProgNum	14	Segment.PVThreshold
3	Segment.Cycles	15	Segment.UserVal
4	Segment.Duration	16	Segment.GsoakType
5	Segment.RampRate	17	Segment.GsoakVal
6	Segment.TargetSP	18	Segment.TimeEvent
7	Segment.EndAction	19	Segment.OnTime
8	Segment.EventOutputs	20	Segment.OffTime
9	Segment.WaitFor	21	Segment.PIDSet
10	Segment.SyncToCh2Seg	22	Segment.PVWait
11	Segment.GobackSeg	23	Segment.WaitVal

### 30.4.5 Example: Programmer 1/2 Segment 1 Parameters

The following table shows the Tag addresses for parameters available in Segment 1 for Programmers 1 and 2. Every segment has the same number of parameters each calculated by adding the offsets shown in the table above to the Segment Type parameter given in the table in section 0.

Segment Data Table – Programmer 1/2			
Tag Address	Parameter	Tag Address	Parameter
5376/6976	Segment 1 Type	5388/6988	Segment 1 Goback Cycles
5377/6977	Segment 1 Holdback	5389/6989	Segment 1 PV Event
5378/6978	Segment 1 Program to be Called	5390/6990	Segment 1 PV Event Threshold
5379/6979	Segment 1 Number of Call Cycles	5391/6991	Segment 1 User Value
5380/6980	Segment 1 Duration	5392/6992	Segment 1 Guaranteed Soak Type
5381/6981	Segment 1 Ramp Rate	5393/6993	Segment 1 Guaranteed Soak Value
5382/6982	Segment 1 Target Setpoint	5394/6994	Segment 1 Time Event
5383/6983	Segment 1 End Type	5395/6995	Segment 1 On Time
5384/6984	Segment 1 Digital Event Outputs	5396/6996	Segment 1 Off Time
5385/6985	Segment 1 Wait For	5397/6997	Segment 1 PID Set
5386/6986	Segment 1 Synchronise to Channel 2 Segment	5398/6998	Segment 1 PV Wait Event
5387/6987	Segment 1 Goback Segment	5399/6999	Segment 1 Wait Value

### 30.5 Synchronous Programmers

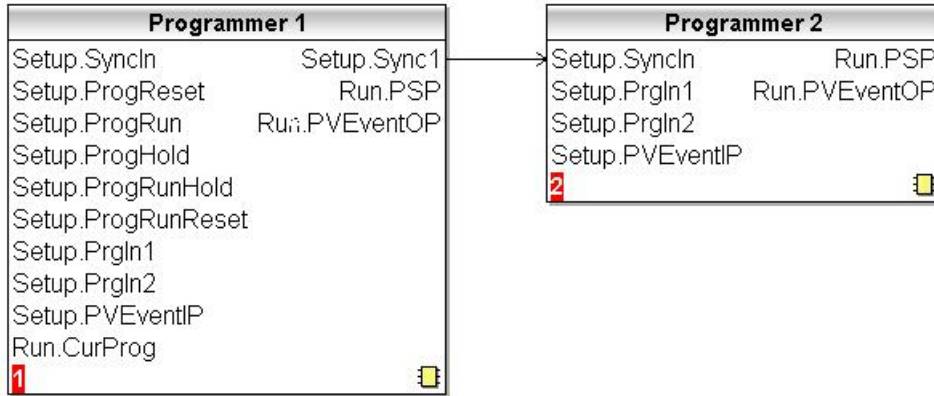

In this configuration Programmer2 is a slave to Programmer1. A program will have two profiles, Channel1 run by Programmer1 and Channel2 run by Programmer2. The program only needs to be loaded into the master programmer. To edit the program and to configure the programmers the following procedure should be followed:

1. Write the program number which is to be edited to the Comms.ProgramNumber parameter located in the master programmers general data area, in this case the master programmer is Programmer1 and hence the address to be written to is:

$$\text{Programmer1 Program General Data Start address (5184) + Comms.ProgNum Offset (0) = 5184}$$

2. It is then possible to configure the other Programmer/Program parameters, for example, the address to write to change the value of the PowerFailAct is:

$$\text{Programmer1 Program General Data Start address (5184) + PowerFailAct Offset (5) = 5189}$$

3. To edit Segment1 Channel1 data, use Programmer1 (Sync Ch1) Segment1 Start address plus the parameter offset, for example, to configure the segment type the address to be written to is:

$$\text{Programmer1 Segment1 Data Start address (5376) + Segment.Type Offset (0) = 5376}$$

To configure Ch1 TargetSP the address to be written to is:

$$\text{Programmer1 Segment1 Data Start address (5376) + Segment.TargetSP Offset (6) = 5382}$$

4. To edit Segment1 Channel2 data, use Programmer2 (Sync Ch2) Segment1 Start address plus the parameter offset, for example, to configure Ch2 TargetSP the address to be written to is:

$$\text{Programmer2 Segment1 Data Start address (6976) + Segment.TargetSP Offset (6) = 6982}$$

For additional segments repeat steps 3 and 4 using the corresponding segment numbers i.e.:

Ch	Segment 1	Segment 2	Segment n
1	Programmer 1 Segment 1 Data	Programmer 1 Segment 2 Data	Programmer1 Segment n Data
2	Programmer 2 Segment 1 Data	Programmer 2 Segment 2 Data	Programmer2 Segment n Data

### 30.6 Asynchronous Programmers

Programmer 1	
Setup.SyncIn	Setup.Sync1
Setup.ProgReset	Run.PSP
Setup.ProgRun	Run.PVEventOP
Setup.ProgHold	
Setup.ProgRunHold	
Setup.ProgRunReset	
Setup.PrgIn1	
Setup.PrgIn2	
Setup.PVEventIP	
Run.CurProg	

Programmer 2	
Setup.SyncIn	Run.PSP
Setup.ProgReset	Run.PVEventOP
Setup.ProgRun	
Setup.ProgHold	
Setup.ProgRunHold	
Setup.ProgRunReset	
Setup.PrgIn1	
Setup.PrgIn2	
Setup.PVEventIP	
Run.CurProg	

In this configuration each programmer can be loaded with its own program. To edit the separate programs and to configure the programmers the following procedure should be followed:

1. Write the program number that is to be edited for Programmer1 to the Comms.ProgNumber parameter located in Programmer1 general data area, the address to be written to is:

*Programmer1 Program General Data Start address (5184) + Comms.ProgNum Offset (0) = 5184*

2. It is then possible to configure the other parameters for Programmer1/Program, for example, the address to write to change the value of the PowerFailAct is:

*Programmer1 Program General Data Start address (5184) + PowerFailAct Offset (5) = 5189*

3. To edit the programs Segment data, use the segment numbers start address plus the parameter offset, for example, to configure the segment type of Segment1 the address to be written to is:

*Programmer1 Segment1 Data Start address (5376) + Segment.Type Offset (0) = 5376*

To configure the segment type of Segment2 the address to be written to is:

*Programmer1 Segment2 Data Start address (5408) + Segment.Type Offset (0) = 5408*

4. To configure Programmer2/Program repeat steps 1 through to 3 using Programmer2 addresses, for example:

Step1 (this does not affect Programmer1 Program Number):

*Programmer2 Program General Data Start address (5248) + Comms.ProgNum Offset (0) = 5248*

Step2:

*Programmer2 Program General Data Start address (5248) + PowerFailAct Offset (5) = 5253*

Step3:

*Programmer2 Segment1 Data Start address (6976) + Segment.Type Offset (0) = 6976*

*Programmer2 Segment2 Data Start address (7008) + Segment.Type Offset (0) = 7008*



## 31. Chapter 31 EI-Bisynch Parameters

818, 902/3/4 mnemonic	818, 902/3/4 Parameter	3500 parameter	Hex / decimal
PV	Measured Value	Loop - PV	Decimal
SP	Working Setpoint	Loop - Working Setpoint	Decimal
OP	Output	Loop - Manual Output	Decimal
SW	See "Status Word Table" below	See "Status Word Table" below	HEX
OS	See "Optional Status Word Table" below	See "Optional Status Word Table" below	HEX
XS	See "Extended Status Word Table" below	See "Extended Status Word Table" below	HEX
01	See "Digital output status word 1" below.	See "Digital output status word 1" below.	HEX
02	See "Digital output status word 2" below.	See "Digital output status word 2" below.	HEX
03	See "Digital output status word 3" below.	See "Digital output status word 3" below.	HEX
04	See "Digital output status word 4" below.	See "Digital output status word 4" below.	HEX
05	See "Digital output status word 5" below.	See "Digital output status word 5" below.	HEX
06	See "Digital output status word 6" below.	See "Digital output status word 6" below.	HEX
1A	Alarm 1	Alarm - 1 - Threshold	Decimal
2A	Alarm 2	Alarm - 2 - Threshold	Decimal
ER	Error	Loop - Diag - Error	Decimal
SL	Local Setpoint (SP1)	Loop - Target Setpoint	Decimal
S2	Setpoint 2 (SP2)	Loop - Setpoint 2	Decimal
RT	Local setpoint trim	Loop - Setpoint Trim	Decimal
MP	V.P. Pot Value	Loop - Ch1 Valve Position	Decimal
RI	Remote Input	Loop - Scheduler Remote Input	Decimal
TM	Time remaining in current program segment	Programmer - Segment time remaining	Decimal
LR	Loops remaining for current program	Programmer - Cycles left	Decimal
r1-r8	Ramp rate 1-8	Programmer - (Ramp) Segment Rates	Decimal
l1-l8	Ramp level 1-8	Programmer - (Ramp) Segment Target setpoints	Decimal
t1-t8	Dwell time 1-8	Programmer - (Dwell) Segment durations	Decimal
Hb	Holdback value	Programmer - Holdback	Decimal
Lc	Loop count	Programmer - Cycles remaining	Decimal
RR	Ramp Rate	Loop - Setpoint Rate Limit Value	Decimal
HO	Max.Heat	Loop - Output High Limit	Decimal
LO	Max Cool	Loop - Output Low Limit	Decimal
RH	Remote Heat Limit	Loop - Remote Output High Limit	Decimal
RC	Remote Cool Limit	Loop - Remote Output Low Limit	Decimal
HS	Setpoint 1 maximum	Loop - Setpoint Hi	Decimal
LS	Setpoint 1 minimum	Loop - Setpoint Lo	Decimal
H2 (TH)	Setpoint 2 maximum	UserVals - UserVal2	Decimal
L2 (TL)	Setpoint 2 minimum	UserVals - UserVal3	Decimal
H3	Local setpoint maximum	UserVals - UserVal4	Decimal
L3	Local setpoint minimum	UserVals - UserVal5	Decimal
2H	Remote Max Scalar	UserVals - UserVal6	Decimal
2L	Remote Min Scalar	UserVals - UserVal7	Decimal

818, 902/3/4 mnemonic	818, 902/3/4 Parameter	3500 parameter	Hex / decimal
CH	Cycle time for channel 1	Mod1 - Chn1 - Min On Time (Same as MT in 3500)	Decimal
XP	Proportional Band	Loop - Proportional Band	Decimal
TI	Integral time	Loop - Integral Time	Decimal
MR	Manual reset	Loop - Manual Reset	Decimal
TD	Derivative time	Loop - Derivative Time	Decimal
HB	Cutback High	Loop - Cutback High (also supported as 'Hb' in 3500)	Decimal
LB	Cutback Low	Loop - Cutback Low	Decimal
RG	Relative cool gain	Loop - Relative Cool/Ch2 Gain	Decimal
P2	Proportional Band 2	Loop - Proportional Band 2	Decimal
I2	Integral time 2	Loop - Integral Time 2	Decimal
R2	Manual reset 2	Loop - Manual Reset 2	Decimal
D2	Derivative tune 2	Loop - Derivative Time 2	Decimal
G2	Relative cool gain 2	Loop - Relative Cool/Ch2 Gain 2	Decimal
AU	Approach 2	UserVals - UserVal13	Decimal
HC	Heat cool deadband	Loop - Channel 2 Deadband	Decimal
CC	Cool cycle time	Mod2 - Ch1 - MinOnTime	Decimal
C2	Channel 2 cycle time	UserVals - UserVal1	Decimal
AL	Approach limit	UserVals - UserVal8	Decimal
TT	Travel time	Loop - Ch1 Travel Time	Decimal
Tt	Travel time down	UserVals - UserVal11	Decimal
MT	Minimum on time	Mod1 - Chn1 - Min On Time (Same as CH in 3500)	Decimal
TP	Valve update time	UserVals - UserVal12	Decimal
HC	Deadband	Loop - Channel 2 Deadband	Decimal
LE	Motor low limit	UserVals - UserVal13	Decimal
EH	Motor high limit	UserVals - UserVal9	Decimal
PE	Emissivity	Standard PV - Emissivity	Decimal
BP	Power level at sensor break	Loop - Safe Output Value	Decimal
TR	Adaptive tune trigger point	UserVals - UserVal10	Decimal
V0	Software version	Software version	HEX
II	Instrument Identity	Instrument ID (3508 = E480 / 3504 = E440)	HEX
1H	Display Maximum	Bar graph max	Decimal
1L	Display Minimum	Bar graph min	Decimal

**31.1.1 (SW) Status Word**

<b>Status Word (SW)</b>		
<b>Bit</b>	<b>818, 902/3/4 Function (Clear/Set)</b>	<b>3500 Support</b>
0	Data Format (Free/Fixed)	Both message format modes supported
1	Sensor Break (No/Yes)	Loop sensor break
2	Key Lock (Enabled/Disabled)	Not Supported - Ignored
3	Spare	N/A
4	Spare	N/A
5	Param changed via keys (No/Yes)	Not Supported - Ignored
6	Spare	N/A
7	Spare	N/A
8	Alarm 2 state (Off/On)	Alarm 2 state
9	Spare	N/A
10	Alarm 1 state (Off/On)	Alarm 1 state
11	Spare	N/A
12	Alarm Active (No alarm/New Alarm1 or 2)	Alarm 1 OR Alarm 2
13	SP2 Active (SP1/SP2)	Loop - Active Setpoint Select
14	Remote Active (Local/Remote)	Loop - Alternate Setpoint Enable
15	Manual Mode (Auto/Man)	Loop - Auto Manual

**31.1.2 (OS) Optional Status word**

<b>Optional Status Word (OS)</b>		
<b>Bit</b>	<b>818, 902/3/4 Function (Clear/Set)</b>	<b>3500 Support</b>
0	Values of the first nibble (Bits 0-3) represent	Supported as described.
1	Program Status. Value of 0=Reset, 2=Run,	
2	3=Hold, 4=End, 5=Ramp End, 6=in holdback	
3	Value of 1 is not used	
4	Hold Logged (R/O).	May be cleared over comms but not set.
5	Skip Current Segment (w/o)	Supported as described.
6	Ramp / Dwell	Supported as described.
7	Digital Input Lock	Not Supported - Ignored - always returns zero.
8	Segment Number LSB	Shows segment number 1-8, read only.
9	Seg No	
10	Seg No	
11	Segment Number MSB	
12	Digital O/P2 (Off/On)	Not supported - Ignored - always returns zero.
13	Digital O/P1 (Off/On)	Relay AA status
14	Digital Input 2 (Off/On)	Fixed Digital I/O 2
15	Digital Input 1 (Off/On)	Fixed Digital I/O 1

**31.1.3 (XS) Extended Status Word**

Extended Status word (XS)		
Bit	818, 902/3/4 Function (Clear/Set)	3500 Support
0	Self Tune (Off/On)	Fully supported
1	Adaptive Tune (Off/On)	Not supported - Ignored - always returns zero.
2	Spare	N/A
3	Spare	N/A
4	PID Control (SP+PID/PID Independ't)	Not supported - Ignored - always returns zero.
5	Active PID set (PID1/PID2)	Supported as described.
6	Digital OP 0 (OP2) (Off/On)	Relay AA status
7	Spare	N/A
8	This Nibble (bits 8-11) represent	Supported as described.
9	program number.	
10		
11		
12	Valve positioners	Not supported -
13	Values are as follows (0=Outputs Off, 1=	This nibble is ignored and always returns zero.
14	Lower Output on, 2=Raise Output on, 3=	
15	Lower Nudge, 4=Raise Nudge)	

**31.1.4 Digital Output Status Word1 (01)**

DigOpStat1 (01)		
Bit	818, 902/3/4 Function (Clear/Set)	3500 Support
0	Ramp 1 to Output 3	Digital Event bit 3 for segment 1 (ramp 1)
1	Dwell 1 to Output 3	Digital Event bit 3 for segment 2 (dwell 1)
2	Ramp 2 to Output 3	Digital Event bit 3 for segment 3 (ramp 2)
3	Dwell 2 to Output 3	Digital Event bit 3 for segment 4 (dwell 2)
4	Ramp 3 to Output 3	Digital Event bit 3 for segment 5 (ramp 3)
5	Dwell 3 to Output 3	Digital Event bit 3 for segment 6 (dwell 3)
6	Ramp 4 to Output 3	Digital Event bit 3 for segment 7 (ramp 4)
7	Dwell 4 to Output 3	Digital Event bit 3 for segment 8 (dwell 4)
8	Ramp 5 to Output 3	Digital Event bit 3 for segment 9 (ramp 5)
9	Dwell 5 to Output 3	Digital Event bit 3 for segment 10 (dwell 5)
10	Ramp 6 to Output 3	Digital Event bit 3 for segment 11 (ramp 6)
11	Dwell 6 to Output 3	Digital Event bit 3 for segment 12 (dwell 6)
12	Ramp 7 to Output 3	Digital Event bit 3 for segment 13 (ramp 7)
13	Dwell 7 to Output 3	Digital Event bit 3 for segment 14 (dwell 7)
14	Ramp 8 to Output 3	Digital Event bit 3 for segment 15 (ramp 8)
15	Dwell 8 to Output 3	Digital Event bit 3 for segment 16 (dwell 8)

**31.1.5 Digital Output Status Word2 (02)**

DigOpStat1 (02)		
Bit	818, 902/3/4 Function (Clear/Set)	3500 Support
0	End to output 3	Digital Event bit 3 for End segment
1-15	Not used / Spare	Not used / Spare

**31.1.6 Digital Output Status Word1 (03)**

<b>DigOpStat1 (03)</b>		
<b>Bit</b>	<b>818, 902/3/4 Function (Clear/Set)</b>	<b>3500 Support</b>
0	Ramp 1 to Output 4	Digital Event bit 4 for segment 1 (ramp 1)
1	Dwell 1 to Output 4	Digital Event bit 4 for segment 2 (dwell 1)
2	Ramp 2 to Output 4	Digital Event bit 4 for segment 3 (ramp 2)
3	Dwell 2 to Output 4	Digital Event bit 4 for segment 4 (dwell 2)
4	Ramp 3 to Output 4	Digital Event bit 4 for segment 5 (ramp 3)
5	Dwell 3 to Output 4	Digital Event bit 4 for segment 6 (dwell 3)
6	Ramp 4 to Output 4	Digital Event bit 4 for segment 7 (ramp 4)
7	Dwell 4 to Output 4	Digital Event bit 4 for segment 8 (dwell 4)
8	Ramp 5 to Output 4	Digital Event bit 4 for segment 9 (ramp 5)
9	Dwell 5 to Output 4	Digital Event bit 4 for segment 10 (dwell 5)
10	Ramp 6 to Output 4	Digital Event bit 4 for segment 11 (ramp 6)
11	Dwell 6 to Output 4	Digital Event bit 4 for segment 12 (dwell 6)
12	Ramp 7 to Output 4	Digital Event bit 4 for segment 13 (ramp 7)
13	Dwell 7 to Output 4	Digital Event bit 4 for segment 14 (dwell 7)
14	Ramp 8 to Output 4	Digital Event bit 4 for segment 15 (ramp 8)
15	Dwell 8 to Output 4	Digital Event bit 4 for segment 16 (dwell 8)

**31.1.7 Digital Output Status Word2 (04)**

<b>DigOpStat1 (04)</b>		
<b>Bit</b>	<b>818, 902/3/4 Function (Clear/Set)</b>	<b>3500 Support</b>
0	End to output 4	Digital Event bit 4 for End segment
1-15	Not used / Spare	Not used / Spare

**31.1.8 Digital Output Status Word1 (05)**

<b>Bit</b>	<b>818, 902/3/4 Function (Clear/Set)</b>	<b>3500 Support</b>
0	Ramp 1 to Output 2	Digital Event bit 2 for segment 1 (ramp 1)
1	Dwell 1 to Output 2	Digital Event bit 2 for segment 2 (dwell 1)
2	Ramp 2 to Output 2	Digital Event bit 2 for segment 3 (ramp 2)
3	Dwell 2 to Output 2	Digital Event bit 2 for segment 4 (dwell 2)
4	Ramp 3 to Output 2	Digital Event bit 2 for segment 5 (ramp 3)
5	Dwell 3 to Output 2	Digital Event bit 2 for segment 6 (dwell 3)
6	Ramp 4 to Output 2	Digital Event bit 2 for segment 7 (ramp 4)
7	Dwell 4 to Output 2	Digital Event bit 2 for segment 8 (dwell 4)
8	Ramp 5 to Output 2	Digital Event bit 2 for segment 9 (ramp 5)
9	Dwell 5 to Output 2	Digital Event bit 2 for segment 10 (dwell 5)
10	Ramp 6 to Output 2	Digital Event bit 2 for segment 11 (ramp 6)
11	Dwell 6 to Output 2	Digital Event bit 2 for segment 12 (dwell 6)
12	Ramp 7 to Output 2	Digital Event bit 2 for segment 13 (ramp 7)
13	Dwell 7 to Output 2	Digital Event bit 2 for segment 14 (dwell 7)
14	Ramp 8 to Output 2	Digital Event bit 2 for segment 15 (ramp 8)
15	Dwell 8 to Output 2	Digital Event bit 2 for segment 16 (dwell 8)

**31.1.9 Digital Output Status Word2 (06)**

<b>DigOpStat1 (06)</b>		
<b>Bit</b>	<b>818, 902/3/4 Function (Clear/Set)</b>	<b>3500 Support</b>
0	End to output 2	Digital Event bit 2 for End segment
1-15	Not used / Spare	Not used / Spare

**31.1.10 Additional mnemonics, typically from 2400**

Mnemonic	3500 parameter	Details / Notes	Hex / decimal
A1	Alarm 1 - Threshold Value		Decimal
A2	Alarm 2 - Threshold Value		Decimal
A3	Alarm 3 - Threshold Value		Decimal
A4	Alarm 4 - Threshold Value		Decimal
A5	Alarm 5 - Threshold Value		Decimal
A6	Alarm 6 - Threshold Value		Decimal
A7	Alarm 7 - Threshold Value		Decimal
A8	Alarm 8 - Threshold Value		Decimal
AH	Loop - Autotune High Output Power Limit		Decimal
AK	Alarm Manager - Global Ack		Decimal
AT	Loop - Autotune Low Output Power Limit		Decimal
Aa	Alarm 7 - Threshold Value		Decimal
Ab	Alarm 8 - Threshold Value		Decimal
Ag	AA Relay - Value		Decimal
C1	User Value 1 - Value		Decimal
C2	User Value 2 - Value		Decimal
C3	User Value 3 - Value		Decimal
C4	User Value 4 - Value		Decimal
C5	User Value 5 - Value		Decimal
C6	User Value 6 - Value		Decimal
C7	User Value 7 - Value		Decimal
C8	User Value 8 - Value		Decimal
C9	User Value 9 - Value		Decimal
CJ	Std PV - CJC Temperature		Decimal
CP	Programmer - Current Program		Decimal
CR	Loop - Setpoint Rate Limit Value		Decimal
CS	Programmer - Current Segment		Decimal
Ca	User Value 10 - Value		Decimal
Cb	User Value 11 - Value		Decimal
Cc	User Value 12 - Value		Decimal
Cd	User Value 13 - Value		Decimal
Ce	User Value 14 - Value		Decimal
Cf	User Value 15 - Value		Decimal
Cg	User Value 16 - Value		Decimal
Cj	Mod2 - Chn1 - CJC Temperature		Decimal
E5	Real Time Clock - On Time 1		Decimal
E6	Real Time Clock - On Time 2		Decimal
EE	Comms error code		Decimal
H1	Options - Display - Bar Graph Max		Decimal
HA	Alarm 1 Out		Decimal
HD	Loop - Cutback High 3		Decimal
IM	Instrument Mode (Read only - 2400 offers read / write)		Decimal
L1	Options - Display - Bar Graph Min		Decimal
LC	Loop - Cutback Low 2		Decimal
LD	Loop - Cutback Low 3		Decimal
LT	Loop - Setpoint Trim		Decimal
Lr	Programmer - Cycles left		Decimal
MU	Mod1 - Chn2 - Min On Time		Decimal
MV	Mod1 - Chn3 - Min On Time		Decimal

Mnemonic	3500 parameter	Details / Notes	Hex / decimal
O1	Loop - Channel 1 Output Value		Decimal
O2	Loop - Channel 2 Output Value		Decimal
OR	Loop - Output Rate Limit Value		Decimal
RD	Loop - Setpoint Rate Limit Disable		Decimal
S1	Loop - Setpoint 1		Decimal
SC	Real time clock - Mode		Decimal
SR	Loop - Working Setpoint		Decimal
ST	Instrument - Set Instrument Into Standby		Decimal
TE	Loop - Derivative Time 2		Decimal
TF	Loop - Derivative Time 3		Decimal
TH	Loop - Remote Output High Limit		Decimal
TJ	Loop - Integral Time 2		Decimal
TK	Loop - Integral Time 3		Decimal
TL	Loop - Remote Output Low Limit		Decimal
W1	Analogue Operator 1 - Value		Decimal
W2	Analogue Operator 2 - Value		Decimal
W3	Analogue Operator 3 - Value		Decimal
W4	Analogue Operator 4 - Value		Decimal
W5	Analogue Operator 5 - Value		Decimal
W6	Analogue Operator 6 - Value		Decimal
W7	Analogue Operator 7 - Value		Decimal
W8	Analogue Operator 8 - Value		Decimal
W9	Analogue Operator 9 - Value		Decimal
WA	Alarm Manager - New Alarm		Decimal
WD	Programmer - Program Run		Decimal
Wa	Analogue Operator 10 - Value		Decimal
Wb	Analogue Operator 11 - Value		Decimal
Wc	Analogue Operator 12 - Value		Decimal
Wd	Analogue Operator 13 - Value		Decimal
We	Analogue Operator 14 - Value		Decimal
Wf	Analogue Operator 15 - Value		Decimal
Wg	Analogue Operator 16 - Value		Decimal
Wh	Analogue Operator 17 - Value		Decimal
Wi	Analogue Operator 18 - Value		Decimal
Wj	Analogue Operator 19 - Value		Decimal
Wk	Analogue Operator 20 - Value		Decimal
Wl	Analogue Operator 21 - Value		Decimal
Wm	Analogue Operator 22 - Value		Decimal
Wn	Analogue Operator 23 - Value		Decimal
Wo	Analogue Operator 24 - Value		Decimal
X2	Loop - Proportional Band 2		Decimal
X3	Loop - Proportional Band 3		Decimal
X5	Real time clock - Off Time 1		Decimal
X6	Real time clock - Off Time 2		Decimal
Z1	Analogue Switch 1 - Status		Decimal
Z2	Analogue Switch 2 - Status		Decimal
Z3	Analogue Switch 3 - Status		Decimal
Z4	Analogue Switch 4 - Status		Decimal
a1	Module 1 - Channel 1 - Value		Decimal
a2	Module 1 - Channel 2 - Value		Decimal

Mnemonic	3500 parameter	Details / Notes	Hex / decimal
a3	Module 1 - Channel 3 - Value		Decimal
a4	Module 2 - Channel 1 - Value		Decimal
a5	Module 2 - Channel 2 - Value		Decimal
a6	Module 2 - Channel 3 - Value		Decimal
as	Loop - State of the Autotune		Decimal
b1	Module 3 - Channel 1 - Value		Decimal
b2	Module 3 - Channel 2 - Value		Decimal
b3	Module 3 - Channel 3 - Value		Decimal
b4	Module 4 - Channel 1 - Value		Decimal
b5	Module 4 - Channel 2 - Value		Decimal
b6	Module 4 - Channel 3 - Value		Decimal
c1	Module 5 - Channel 1 - Value		Decimal
c2	Module 5 - Channel 2 - Value		Decimal
c3	Module 5 - Channel 3 - Value		Decimal
c4	Module 6 - Channel 1 - Value		Decimal
c5	Module 6 - Channel 2 - Value		Decimal
c6	Module 6 - Channel 3 - Value		Decimal
mA	Loop - Auto/Manual Mode		Decimal
o1	Std PV - Offset		Decimal
o2	Module 1 - Channel 1 - Offset		Decimal
rE	Loop - Scheduler Remote Input		Decimal
td	Real time clock - current day		Decimal
tm	Real time clock - current time		Decimal
x4	Alarm Manager - Alarm 1 State		Decimal
x5	Alarm Manager - Alarm 2 State		Decimal
x6	Alarm Manager - Alarm 3 State		Decimal
x7	Alarm Manager - Alarm 4 State		Decimal
x8	Alarm Manager - Alarm 5 State		Decimal
x9	Alarm Manager - Alarm 6 State		Decimal
xa	Alarm Manager - Alarm 7 State		Decimal
xb	Alarm Manager - Alarm 8 State		Decimal
xc	Alarm Manager - Alarm 9 State		Decimal
xd	Alarm Manager - Alarm 10 State		Decimal
xe	Alarm Manager - Alarm 11 State		Decimal
xf	Alarm Manager - Alarm 12 State		Decimal
xg	Alarm Manager - Alarm 13 State		Decimal
xh	Alarm Manager - Alarm 14 State		Decimal
xi	Alarm Manager - Alarm 15 State		Decimal
xj	Alarm Manager - Alarm 16 State		Decimal
xk	Module 1 - Sensor Break		Decimal
xl	Module 2 - Sensor Break		Decimal
xm	Module 3 - Sensor Break		Decimal
xn	Module 4 - Sensor Break		Decimal
xo	Module 5 - Sensor Break		Decimal
xp	Module 6 - Sensor Break		Decimal
xq	Std PV - Sensor Break		Decimal
xr	Analogue Alarms Summary Byte		Decimal



## 32. Appendix A Safety and EMC Information

This controller is manufactured in the UK by Eurotherm Controls Ltd.

Please read this section carefully before installing the controller

This controller is intended for industrial temperature and process control applications when it will meet the requirements of the European Directives on Safety and EMC. If the instrument is used in a manner not specified in this manual, the safety or EMC protection provided by the instrument may be impaired. The installer must ensure the safety and EMC of any particular installation.

### Safety

This controller complies with the European Low Voltage Directive 73/23/EEC, by the application of the safety standard EN 61010.

### Electromagnetic compatibility

This controller conforms with the essential protection requirements of the EMC Directive 89/336/EEC, by the application of appropriate product specific international standards. This instrument satisfies the general requirements of the commercial and industrial environments defined in EN 61326. For more information on product compliance refer to the Technical Construction File.

### 32.1 GENERAL

The information contained in this manual is subject to change without notice. While every effort has been made to ensure the accuracy of the information, your supplier shall not be held liable for errors contained herein.

### Unpacking and storage

The packaging should contain an instrument mounted in its sleeve, two mounting brackets for panel installation and an Installation & Operating guide. Certain ranges are supplied with an input adapter.

If on receipt, the packaging or the instrument are damaged, do not install the product but contact your supplier. If the instrument is to be stored before use, protect from humidity and dust in an ambient temperature range of -10°C to +70°C.

### 32.2 Service and repair

This controller has no user serviceable parts. Contact your supplier for repair.

#### Caution: Charged capacitors

Before removing an instrument from its sleeve, disconnect the supply and wait at least two minutes to allow capacitors to discharge. It may be convenient to partially withdraw the instrument from the sleeve, then pause before completing the removal. In any case, avoid touching the exposed electronics of an instrument when withdrawing it from the sleeve.

Failure to observe these precautions may cause damage to components of the instrument or some discomfort to the user.

#### Electrostatic discharge precautions

When the controller is removed from its sleeve, some of the exposed electronic components are vulnerable to damage by electrostatic discharge from someone handling the controller. To avoid this, before handling the unplugged controller discharge yourself to ground.

#### Cleaning

Do not use water or water based products to clean labels or they will become illegible. Isopropyl alcohol may be used to clean labels. A mild soap solution may be used to clean other exterior surfaces of the product.

## 32.3 Installation Safety Requirements

### Safety Symbols

Various symbols are used on the instrument, they have the following meaning:



Caution (refer to the accompanying documents)



Protective Conductor Terminal

### Personnel

Installation must only be carried out by suitably qualified personnel.

### Enclosure of live parts

To prevent hands or metal tools touching parts that may be electrically live, the controller must be installed in an enclosure.

### Caution: Live sensors

The controller is designed to operate with the temperature sensor connected directly to an electrical heating element. However you must ensure that service personnel do not touch connections to these inputs while they are live. With a live sensor, all cables, connectors and switches for connecting the sensor must be mains rated.

The logic IO is not isolated from the PV inputs.

### Wiring

It is important to connect the controller in accordance with the wiring data given in this guide. Take particular care not to connect AC supplies to the low voltage sensor input or other low level inputs and outputs. Only use copper conductors for connections (except thermocouple inputs) and ensure that the wiring of installations comply with all local wiring regulations. For example in the UK use the latest version of the IEE wiring regulations, (BS7671). In the USA use NEC Class 1 wiring methods.

### Power Isolation

The installation must include a power isolating switch or circuit breaker. The device should be mounted in close proximity to the controller, within easy reach of the operator and marked as the disconnecting device for the instrument.

### Overcurrent protection

The power supply to the system should be fused appropriately to protect the cabling to the units.

### Voltage rating

The maximum continuous voltage applied between any of the following terminals must not exceed 264Vac:

- relay output to logic, dc or sensor connections;
- any connection to ground.

The controller must not be wired to a three phase supply with an unearthed star connection. Under fault conditions such a supply could rise above 264Vac with respect to ground and the product would not be safe.

### Conductive pollution

Electrically conductive pollution must be excluded from the cabinet in which the controller is mounted. For example, carbon dust is a form of electrically conductive pollution. To secure a suitable atmosphere, install an air filter to the air intake of the cabinet. Where condensation is likely, for example at low temperatures, include a thermostatically controlled heater in the cabinet.

This product has been designed to conform to BSEN61010 installation category II, pollution degree 2. These are defined as follows:-

**Installation Category II**

The rated impulse voltage for equipment on nominal 230V supply is 2500V.

**Pollution Degree 2**

Normally only non conductive pollution occurs. Occasionally, however, a temporary conductivity caused by condensation shall be expected.

**Grounding of the temperature sensor shield**

In some installations it is common practice to replace the temperature sensor while the controller is still powered up. Under these conditions, as additional protection against electric shock, we recommend that the shield of the temperature sensor is grounded. Do not rely on grounding through the framework of the machine.

**Over-Temperature Protection**

When designing any control system it is essential to consider what will happen if any part of the system should fail. In temperature control applications the primary danger is that the heating will remain constantly on. Apart from spoiling the product, this could damage any process machinery being controlled, or even cause a fire.

Reasons why the heating might remain constantly on include:

- the temperature sensor becoming detached from the process
- thermocouple wiring becoming short circuit;
- the controller failing with its heating output constantly on
- an external valve or contactor sticking in the heating condition
- the controller setpoint set too high.

Where damage or injury is possible, we recommend fitting a separate over-temperature protection unit, with an independent temperature sensor, which will isolate the heating circuit.

Please note that the alarm relays within the controller will not give protection under all failure conditions.

**32.4 Installation requirements for EMC**

To ensure compliance with the European EMC directive certain installation precautions are necessary as follows:

- For general guidance refer to EMC Installation Guide, HA025464.
- When using relay outputs it may be necessary to fit a filter suitable for suppressing the conducted emissions. The filter requirements will depend on the type of load.
- If the unit is used in table top equipment which is plugged into a standard power socket, then it is likely that compliance to the commercial and light industrial emissions standard is required. In this case to meet the conducted emissions requirement, a suitable mains filter should be installed.

**Routing of wires**

To minimise the pick-up of electrical noise, the low voltage DC connections and the sensor input wiring should be routed away from high-current power cables. Where it is impractical to do this, use shielded cables with the shield grounded at both ends. In general keep cable lengths to a minimum.

### 33. Appendix B Technical Specification

#### Environmental performance

Temperature limits	Operation: 0 to 50°C
Storage:	-10 to 70°C
Humidity limits	Operation: 5 to 95% RH non condensing Storage: 5 to 95% RH non condensing
Panel sealing	IP65, NEMA 12
Shock	EN61010
Vibration	2g peak, 10 to 150Hz
Altitude	<2000 metres
Atmospheres	Not suitable for use in explosive or corrosive atmosphere
Electromagnetic compatibility (EMC)	EN61326-1: 2006 Class B
Emissions and immunity	EN61010-1: 2001 Suitable for domestic, commercial and light industrial as well as heavy industrial. (Domestic/light (Class B) emissions. Industrial (Class A) environmental immunity emissions. With Ethernet or DeviceNet module fitted the product is only suitable for Industrial (Class A) emissions.
Electrical safety	EN61010 Installation cat. II; Pollution degree 2
INSTALLATION CATEGORY II	The rate impulse voltage for equipment on nominal 230V mains is 2500V.
POLLUTION DEGREE 2	Normally, only non-conductive pollution occurs. Occasionally, however, a temporary conductivity caused by condensation shall be expected

#### Physical

Panel mounting	3508: 1/8 DIN 3504: 1/4 DIN
Dimensions and weight	3508 48W x 96H x 150D mm, 400g 3504: 96W x 96H x 150D mm, 600g
Panel cut-out dimensions and weight	3508: 45W x 92Hmm 0.6kg 3504: 92W x 92Hmm 0.4kg

#### Operator interface

Type	STN LCD with backlight
Main PV display	3508: 4 1/2 digits. green 3504: 5 digits, green
Message display	3508: 8 character header and 3 lines of 10 characters 3504: 16 character header and 3 lines of 20 characters
Status beacons	Units, outputs, alarms, program status, program events, active setpoint, manual, remote SP
Access levels	3 operator plus config. Password protected

#### User pages

Number	8
Parameters	64 total
Functions	Text, conditional text, values, bargraph
Access level	User selectable (level 1, 2 or 3)

**Power requirements**

Supply voltage	100 to 230Vac, $\pm 15\%$ , 48 to 62 Hz, max 20W (3508 15W) 24Vac, -15%, +10%, 48 to 62 Hz 24Vdc, -15% +20% $\pm 5\%$ ripple voltage, max 20W (3508 15W)
Inrush current	High Voltage (VH): 30A duration <100 $\mu$ S Low Voltage (VL): 15A duration <100 $\mu$ S
Approvals	CE, cUL listed (file E57766), Gost

**Communications**

No of ports	2 modules can be fitted
Slot allocation	Modbus RTU or I/O expander only in J comms port

**Serial communications option**

Protocols	Modbus RTU Slave Profibus DP DeviceNet EI-Bisync (818 style mnemonics) Modbus RTU master broadcast (1 parameter) I/O Expander
-----------	--

Isolation	264Vac, double insulated
Transmission standard	EIA232, EIA485, CAN (DeviceNet), Profibus Slot H only

**Ethernet communications option**

Protocol	Modbus TCP, 10baseT
Isolation	264Vac, double insulated
Transmission standard	802.3
Features	DHCP client, 4 simultaneous masters, preferred master
<b>DeviceNet</b>	Slot H only
Maximum baud rate	500KB

**Main Process Variable Input**

Calibration accuracy	$\leq \pm 0.1\%$ of reading $\pm 1$ LSD (1)
Sample rate	9Hz (110ms)
Isolation	264Vac double insulation from the PSU and communication
Input filter	Off to 59.9s. Default 1.6s
Zero offset	User adjustable over full range
User Calibration	2-point gain & offset

**Thermocouple**

Range	Uses 40mV and 80mV ranges dependent on type K, J, N, R, S, B, L, T, C, PL2, custom download (2)
Resolution	16 bits
Linearisation accuracy	$< 0.2\%$ of reading
Cold junction compensation	$> 40:1$ rejection of ambient change External reference of 0°C, 45°C and 50°C
Cold junction accuracy	$\leq \pm 1^\circ\text{C}$ at 25°C ambient

**Resistance Thermometer**

Range	0-400 (-200°C to +850°C)
Resistance Thermometer types	3-wire Pt100 DIN 43760
Resolution (°C)	$< 0.050^\circ\text{C}$ with 1.6sec filter
Resolution	16 bits
Linearity error	$\leq \pm 0.033\%$ (best fit straight line)
Calibration error	$\leq \pm 0.310^\circ\text{C}/^\circ\text{C}$ , $\pm 0.023\%$ of measurement at 25°C Drift with temperature $\leq \pm 0.010^\circ\text{C}/^\circ\text{C}$ , $\pm 25\text{ppm}/^\circ\text{C}$ of measurement from 25°C
Common mode rejection	$< 0.000085^\circ\text{C}/\text{V}$ (maximum of 264Vrms)
Series mode rejection	$< 0.240^\circ\text{C}/\text{V}$ (maximum of 280mV pk-pk),
Lead resistance	0 to 22 matched lead resistance
Input impedance	100M $\Omega$
Bulb current	200 $\mu$ A
<b>40mV Range</b>	
Range	-40mV to +40mV
Resolution ( $\mu$ V)	$< 1.0\mu\text{V}$ with 1.6sec filter
Resolution	16 bits
Linearity error	$< 0.033\%$ (best fit straight line)
Calibration error	$\leq \pm 4.6\mu\text{V}$ , $\pm 0.053\%$ of measurement at 25°C
Drift with temperature	$\leq \pm 0.2\mu\text{V}/^\circ\text{C}$ , $\pm 28\text{ppm}/^\circ\text{C}$ of measurement from 25°C
Common mode rejection	$> 175\text{dB}$ (maximum of 264Vrms)
Series mode rejection	$> 101\text{dB}$ (maximum of 280mV pk-pk)

Input leakage current	±14nA
Input impedance	100MΩ
<b>80mV Range</b>	
Range	<3.3μV with 1.6sec filter -80mV to +80mV
Resolution (μV)	
Resolution	16 bits
Linearity error	<0.033% (best fit straight line)
Calibration error	<±7.5μV, ±0.052% of measurement at 25°C
Drift with temperature	<±0.2μV/°C, ±28ppm/C of measurement from 25°C
Common mode rejection	>175dB (maximum of 264Vrms)
Series mode rejection	>101dB (maximum of 280mV pk-pk)
Input leakage current	±14nA
Input impedance	100MΩ
<b>2V Range</b>	
Range	-1.4V to +2.0V
Resolution (mV)	<90μV with 1.6sec filter
Resolution	16 bits
Linearity error	<0.015% (best fit straight line)
Calibration error	<±420μV, ±0.044% of measurement at 25°C
Drift with temperature	<±125μV/C, ±28ppm/C of measurement from 25°C
Common mode rejection	>155dB (maximum of 264Vrms)
Series mode rejection	>101dB (maximum of 4.5V pk-pk)
Input leakage current	±14nA
Input impedance	100MΩ
<b>10V Range</b>	
Range	-3.0V to +10.0V
Resolution (mV)	<550μV with 1.6sec filter
Resolution	16 bits
Linearity error	<0.007% of reading for zero source resistance. Add 0.003% for each 10 <sup>?</sup> of source plus lead resistance
Calibration error	<±1.5mV, ±0.063% of measurement at 25°C
Drift with temperature	<±66μV/C, ±60ppm/C of measurement from 25°C
Common mode rejection	>145dB (maximum of 264Vrms allowed)
Series mode rejection	>92dB ((maximum of 5V pk-pk allowed)
Input impedance	62.5kΩ to 667kΩ depending on input voltage
<b>Notes</b>	
(1)	Calibration accuracy quoted over full ambient operating range and for all input linearisation types
(2)	Contact Eurotherm for details of availability of custom downloads for alternative sensors
<b>Transmitter PSU (LA and LB)</b>	
Rating	24Vdc, 20mA with LA/LB connected in parallel
Isolation	264Vac double insulation from the PSU and communication
<b>Digital IO (LA and LB)</b>	
Isolation	Not isolated from each other. 264Vac double insulation from the PSU and communication
<b>Input</b>	
Rating	Voltage level: Open 0 to 7.3Vdc Closed 10.8 to 24Vdc Contact Closure: Open >1200Ω Closed <480Ω
Functions	Includes program control, alarm acknowledge, SP2 select, manual, keylock, RSP select, standby
<b>Output</b>	
Rating	18Vdc @ 15mA (min 9mA)10
Functions	Includes control outputs, alarms, events, status
<b>AA Relay</b>	
Type	Form C (changeover)
Rating	Min 1mA @ 1Vdc, Max 2A @ 264Vac resistive1,000,000 operations with external snubber
Isolation	264Vac double insulation
Functions	Includes control outputs, alarms, events, status
<b>Input / Output Modules</b>	
IO Modules 3508	3 modules can be fitted
IO Modules 3504:	6 modules can be fitted

**Analogue Input Module**

Calibration accuracy	$\pm 0.2\%$ of reading $\pm 1\text{LSD}$
Sample rate	9Hz (110ms)
Isolation	264Vac double insulation
Input filter	Off to 59.9s. Default 1.6s
Zero offset	User adjustable over full range
User Calibration	2-point gain & offset
Functions	Includes process input, remote setpoint, power limit

**Thermocouple**

Range	-100mV to +100mV
Types	K, J, N, R, S, B, L, T, C, PL2, custom Resolution ( $\mu\text{V}$ ) $< 3.3\mu\text{V}$ @ 1.6s filter time
Effective resolution	15.9 bits
Linearisation accuracy	$< 0.2\%$ of reading
Cold junction compensation	$> 25:1$ rejection of ambient change External reference of $0^\circ\text{C}$ , $45^\circ\text{C}$ and $50^\circ\text{C}$
Cold junction accuracy	$< \pm 1^\circ\text{C}$ at $25^\circ\text{C}$ ambient

**Resistance Thermometer**

Range	0-400 ( $-200^\circ\text{C}$ to $+850^\circ\text{C}$ )
Resistance Thermometer types	3-wire Pt100 DIN 43760
Resolution ( $^\circ\text{C}$ )	$< \pm 0.08^\circ\text{C}$ with 1.6sec filter
Effective Resolution	13.7 bits
Linearity error	$< 0.033\%$ (best fit straight line)
Calibration error	$< \pm (0.4^\circ\text{C} + 0.15\%$ of reading in $^\circ\text{C})$
Drift with temperature	$< \pm (0.015^\circ\text{C} + 0.005\%$ of reading in $^\circ\text{C})$ per $^\circ\text{C}$
Common mode rejection	$< 0.000085^\circ\text{C}/\text{V}$ (maximum of 264Vrms)
Series mode rejection	$< 0.240^\circ\text{C}/\text{V}$ (maximum of 280mV pk-pk)
Lead resistance	0 To 22, matched lead resistance
Bulb current	300 $\mu\text{A}$
Input impedance	100M $\Omega$

**100mV Range**

Range	-100mV to +100mV
Resolution ( $\mu\text{V}$ )	$< 3.3\mu\text{V}$ with 1.6s filter time
Effective resolution	15.9 bits
Linearity error	$< 0.033\%$ (best fit straight line)
Calibration error	$< \pm 10\mu\text{V}$ , $\pm 0.2\%$ of measurement at $25^\circ\text{C}$
Drift with temperature	$< \pm 0.2\mu\text{V} + 0.004\%$ of reading per $^\circ\text{C}$
Common mode rejection	$> 146\text{dB}$ (maximum of 264Vrms)
Series mode rejection	$> 90\text{dB}$ (maximum of 280mV pk-pk)
Input leakage current	$< 10\text{nA}$
Input impedance	$> 100\text{M}\Omega$

**2V Range**

Range	-0.2V to +2.0V
Resolution ( $\mu\text{V}$ )	30 $\mu\text{V}$ with 1.6s filter time
Effective resolution	16.2bits
Linearity error	$< 0.033\%$ (best fit straight line)
Calibration error	$< \pm 2\text{mV} + 0.2\%$ of reading
Drift with temperature	$< \pm 0.1\text{mV} + 0.004\%$ of reading per $^\circ\text{C}$
Common mode rejection	$> 155\text{dB}$ (maximum of 264Vrms)
Series mode rejection	$> 101\text{dB}$ (maximum of 4.5V pk-pk)
Input leakage current	$< 10\text{nA}$
Input impedance	$> 100\text{M}\Omega$

**10V Range**

Range	-3.0V to +10.0V
Resolution ( $\mu\text{V}$ )	$< 300\mu\text{V}$ with 1.6sec filter
Effective resolution	15.4 bits
Linearity error	$< 0.033\%$ (best fit straight line)
Calibration error	$< \pm (0.4^\circ\text{C} + 0.15\%$ of reading in $^\circ\text{C})$
Drift with temperature	$< \pm 0.1\text{mV} + 0.02\%$ of reading per $^\circ\text{C}$
Common mode rejection	$> 145\text{dB}$ (maximum of 264Vrms)
Series mode rejection	$> 92\text{dB}$ (maximum of 5V pk-pk)
Input impedance	$> 69\text{k}\Omega$

**Potentiometer Input**

Type	Single channel
Resistance	100Ω To 15kΩ,
Excitation	0.5Vdc supplied by module
Isolation	264Vac double insulation
Functions	Includes valve position and remote setpoint

**Analogue Control Output**

Type	Single channel and dual channel (4-20mA only)
Rating	0-20mA <600Ω 0-10Vdc >500Ω
Accuracy	±2.5%
Resolution	10 bits
Isolation	264Vac double insulation

**Analogue Retransmission Output**

Type	Single channel
Rating	0-20mA <600Ω 0-10Vdc >500Ω
Accuracy	±0.5%
Resolution	11 bits
Isolation	264Vac double insulation

**Logic Input Modules**

Module types	Triple contact closure, triple logic level
Isolation	No channel isolation. 264Vac double insulation from other modules and system
Rating	Voltage Level: Open -3 to 5Vdc @ <-0.4mA Closed 10.8 to 30Vdc @ 2.5mA Contact Closure: Open >28kΩ Closed <100Ω
Functions	Includes program control, alarm acknowledge, SP2 select, manual, keylock, RSP select, standby

**Logic Output Modules**

Module types	Single channel, triple channel
Isolation	No channel isolation. 264Vac double insulation from other modules and system
Rating	Single: 12Vdc @ 24mA, source Triple: 12Vdc @ 9mA, source
Functions	Includes control outputs, alarms, events, status

**Relay Modules**

Module types	Single channel Form A, Single channel Form C, dual channel Form A
Isolation	264Vac double insulation
Rating	Min 100mA @ 12Vdc, Max 2A @ 264Vac resistive Min 400,000 (max load) operations with external snubber
Functions	Includes control outputs, alarms, events, status

**Triac Modules**

Module types	Single channel, dual channel
Isolation	264Vac double insulation
Rating	<0.75A @ 264Vac resistive
Functions	Includes control outputs, alarms, events, status

**Transmitter PSU Module**

Type	Single channel
Isolation	264Vac double insulation
Rating	24Vdc @ 20mA

**Transducer PSU Module**

Type	Single channel
Isolation	264Vac double insulation
Bridge voltage	Software selectable 5Vdc or 10Vdc
Bridge resistance	300Ω to 15kΩ
Internal shunt resistor	30.1KΩ @0.25%, used for calibration of 350Ω bridge at 80%

**I/O Expander**

Type	20 I/O: 4 Form C relays, 6 Form A relays, 10 logic inputs 40 I/O: 4 Form C relays, 16 Form A relays, 20 logic inputs
Isolation	264Vac double insulation between channels. 264Vac double insulation between channels
Ratings	Relay: Min 100mA @ 12Vdc, Max 2A @ 264Vac resistive Logic input: Open -3 to 5Vdc @ <-0.4mA Closed 10.8 to 30Vdc @ 2.5mA
Communications	Using EX comms module in comms slot J



**Software features Control**

Number of loops	2
Control types	PID, OnOff, VP, Dual VP
Cooling types	Linear, fan, oil, water
Modes	Auto, manual, forced manual, control inhibit
Overshoot inhibition	High and low cutbacks
Number of PID sets	3, selectable on PV, SP, OP, On Demand, program segment and remote input
Control options	Supply voltage compensation, feedforward, output tracking, OP power limiting, SBR safe output
Setpoint options	Remote SP with trim, SP rate limit, 2nd Setpoint, tracking modes

**Setpoint programmer**

Program function	50 programs, max 500 segments
Program names	User defined up to 16 characters
No of profile channels	2 (1 if single loop)
Operation	Full or partially synchronised
Events	8 per channel (8 when fully synchronised) 1 timed event, 1 PV event
Segment types	Rate, dwell, time, call, goback and wait
Digital inputs	Run, Hold, Reset, RunHold, RunReset, Adv Seg, Skip Seg
Servo action	Process value or setpoint
Power failure modes	Continue, ramp, reset
Other functions	Guaranteed soak, holdback, segment user values, wait inputs, PV hot start

**Process Alarms**

Number	8
Type	High, low, devhi, devlo, devband
Latching	None, auto, manual, event
Other features	Delay, inhibit, blocking, display message, 3 priority levels

**Digital Alarms**

Number	8
Type	PosEdge, negEdge, edge, high, low
Latching	None, auto, manual, event
Other features	Delay, blocking, inhibit, display message, 3 priority levels

**Zirconia**

Number	1
Functions	Carbon potential, dewpoint, %O <sub>2</sub> LogO <sub>2</sub> , probe mV
Supported probes	Barber Colman, Drayton, MMICarbon, AACC, Accucarb, SSI, MacDhui, BoschO <sub>2</sub> , BoschCarbon
Gas reference	Internal or remote analogue input
Probe diagnostics	Clean recovery time, impedance measurement
Probe burn-off	Automatic or manual
Other features	Sooting alarm with tolerance setting, PV offsets

**Humidity**

Number	1
Functions	Relative humidity, dewpoint
Measurement	Psychrometric (wet & dry) inputs
Atmosphere compensation	Internal or remote analogue input
Other features	Psychrometric constant adjust

**Recipes**

Number	8
Parameters	24 per recipe
Length of Name	8 Characters
Selection	HMI, comms, strategy

**Transducer calibration**

Number	2
Type	Shunt, load cell, comparison
Other features	Autotare

**Communication tables**

Number	250
Function	Modbus remapping (indirection)
Data formats	Integer, IEEE (full resolution)

**Application Blocks**

Soft wiring	Orderable options of 30, 60 120 or 250 User values: 16 real numbers with decimal point.
2 Input maths	24 blocks, add, subtract, multiply, divide, absolute difference, maximum, minimum, hot swap, sample and hold, power, square root, Log, Ln, exponential, switch.
2 Input logic	24 blocks, AND, OR, XOR, latch, equal, not equal, greater than, less than, greater than or equal to.
8 Input logic	2 blocks AND OR, XOR
8 Input multiplexor	4 blocks. 8 sets of 8 values selected by input parameter
8 Input multiple input	3 blocks, average, min, max sum
BCD Input	2 blocks, 2 Decades
Input monitor	2 blocks, max, min, time above threshold
16 Point linearisation	2 blocks, 16-point linearisation fit
Polynomial fit:	2 blocks, characterisation by Poly Fit table. Switchover: 1 block, smooth transition between two values
Timer blocks	4 blocks, OnPulse, OnDelay, OneShot, MinOn Time
Counter blocks	2 blocks, Up or down, directional flag
Totaliser blocks	2 blocks, alarm at threshold value
Real time clock	1 block, day & time, 2 time based alarms

## 34. Appendix C Parameter Index

Below is an alphabetical index of parameters used in the 3500 series controllers.

Parameter	Location	Section	Parameter	Location	Section
10 x	Math Operators	18.3.1.	Cal State	Cal PVInput	26.4.
A/Man Func	Access	3.2	Cal Status	Txdr	24.6.
A/Man Key	Inst Dia	6.7.	Cal Trim	Mod	10.3.
AbsDif	Math Operators	18.3.1.	Cal Type	Txdr	24.6.
aC_CO_O2	Zirconia	16.4.	Call Cycles	Prog Edit Sync Start	22.17.2.
Ack	AnAlm	12.4.	Call Cycles	Single Program Edit	22.19.1.
Active Set	Lp PID	21.5.1.	Call program	Prog Edit Sync Start	22.17.2.
Add	Math Operators	18.3.1.	Call Program	Single Program Edit	22.19.1.
Address	Comms	14.3.	CalStateHi	Mod	10.3.
Address	Mstrcomms	14.9.2.	CalStateLo	Mod	10.3.
Advance	Program Setup	22.16.	CantClean	Zirconia	16.4.
Alarm OP	Total	15.3.1.	CarbonPot	Zirconia	16.4.
Alarm Page	Inst Dis	6.5.	Casc In	MultiOp	18.5.6.
Alarm SP	Total	15.3.1.	Casc Num In	MultiOp	18.5.6.
Alarm Summary	Inst Dis	6.5.	CBH/CBH2/	Lp PID	21.5.1.
Alm Days	IPMon	17.2.	CBH3	Lp PID	21.5.1.
Alm Out	IPMon	17.2.	CBL/CBL2/	Lp PID	21.5.1.
Alm Time	IPMon	17.2.	CBL3	Lp PID	21.5.1.
Alt SP	Lp SP	21.7.1.	Ch 2 Gain	Load	20.1.
Alt SP En	Lp SP	21.7.1.	Ch1 Hldbck Type	Prog Edit Sync All	22.17.1.
AnAlm En	Inst Enb	6.3.1.	Ch1 OnOff Hyst	Lp OP	21.8.1.
AND	Logic operators	18.1.2.	Ch1 Output	Lp OP	21.8.1.
Atten	Load	20.1.	Ch1 Pot Brk	Lp OP	21.8.1.
Auto/Man Key	Access	3.2	Ch1 Pot Pos	Lp OP	21.8.1.
AutoMan	LP Main	21.3.1.	Ch1 PV Event	Prog Edit Sync All	22.17.1.
Aux1 Bar Val	Inst Dis	6.5.	Ch1 PV Thresh	Prog Edit Sync All	22.17.1.
Aux2 Bar Val	Inst Dis	6.5.	Ch1 Target SP	Prog Edit Sync All	22.17.1.
Average Out	MultiOp	18.5.6.	Ch1 TravelT	Lp OP	21.8.1.
Backlash	Lgc IO	8.2.	Ch1/2 Control	LP Setup	21.4.2.
Backlash	Mod	10.3.	Ch1/2 PV Wait	Prog Edit Sync All	22.17.1.
Ballnt	Zirconia	16.4.	Ch1/2 Wait Val	Prog Edit Sync All	22.17.1.
Bar Scale Max	Inst Dis	6.5.	Ch1HldBk Value	Prog Edit Sync All	22.17.1.
Bar Scale Min	Inst Dis	6.5.	Ch1PVStart	Prog Edit Sync All	22.17.1.
Baud Rate	Comms	14.3.	Ch2 DeadB	Lp OP	21.8.1.
Bcast Val	Comms	14.3.	Ch2 Hldbck Type	Prog Edit Sync All	22.17.1.
BCD Value	BCDIn	12.6.	Ch2 OnOff Hyst	Lp OP	21.8.1.
BCDIn En	Inst Enb	6.3.1.	Ch2 Output	Lp OP	21.8.1.
Block	AnAlm	12.4.	Ch2 Pot Brk	Lp OP	21.8.1.
Boundary 1-2	Lp PID	21.5.1.	Ch2 Pot Pos	Lp OP	21.8.1.
Boundary 2-3	Lp PID	21.5.1.	Ch2 Target SP	Prog Edit Sync All	22.17.1.
Broadcast	Comms	14.3.	Ch2 TravelT	Lp OP	21.8.1.
Cal Active	Txdr	24.6.	Ch2HldBk Value	Prog Edit Sync All	22.17.1.
Cal Band	Txdr	24.6.	Ch2PVStart	Prog Edit Sync All	22.17.1.
Cal Enable	Txdr	24.6.	Ch2Seg	Prog Edit Sync Start	22.17.2.
Cal State	PV Input	7.2.	Channel	Program Setup	22.16.
Cal State	Lgc IO	8.2.	CJC Temp	PV Input	7.2.
Cal State	Mod	10.3.			

Parameter	Location	Section
CJC Temp	Mod	10.3.
CJC Type	PV Input	7.2.
CJC Type	Mod	10.3.
CleanAbort	Zirconia	16.4.
CleanFreq	Zirconia	16.4.
CleanProb	Zirconia	16.4.
CleanStat	Zirconia	16.4.
CleanTime	Zirconia	16.4.
CleanValv	Zirconia	16.4.
Clear Cal	Txdr	24.6.
Clear Log	Inst Dia	6.7.
Clear Memory	Access	3.2
Clear O'flow	Count	15.1.1.
Clear Stats	Inst Dia	6.7.
ClnAbort	Zirconia	16.4.
ClnEnabl	Zirconia	16.4.
ClnMaxT	Zirconia	16.4.
ClnMsgRt	Zirconia	16.4.
ClnRcovT	Zirconia	16.4.
Clock	Count	15.1.1.
Cntr1 Overrun	Inst Dia	6.7.
CO_Inuse	Zirconia	16.4.
CO_Local	Zirconia	16.4.
CO_RemEn	Zirconia	16.4.
CO_Remote	Zirconia	16.4.
Comms Delay	Comms	14.3.
Comms Stack Free	Inst Dia	6.7.
Company ID	Inst Inf	6.6.
Con Ticks	Inst Dia	6.7.
Config Code	Access	3.2
Control Act	LP Setup	21.4.2.
Control1 Page	Inst Dis	6.5.
Control2 Page	Inst Dis	6.5.
Cool Type	Lp OP	21.8.1.
Count	Mstrcomms	14.9.2.
Count	Count	15.1.1.
Counter En	Inst Enb	6.3.1.
CPU % Free	Inst Dia	6.7.
CPU % Min	Inst Dia	6.7.
Ctl Stack Free	Inst Dia	6.7.
Cust1 Name No tbl	Inst Dia	6.7.
Cust2 Name No tbl	Inst Dia	6.7.
Cust3 Name No tbl	Inst Dia	6.7.
Customer ID	Access	3.2
Cycle Time	Mod	10.3.
Cycles	Prog Edit Sync All	22.17.1.
Cycles	Single Program Edit	22.19.1.
CycleTime	Lgc IO	8.2.
Day	RTClock	15.4.1.
Days Above	IPMon	17.2.

Parameter	Location	Section
Dec Value	BCDIn	12.6.
Default GW 1	Comms	14.4.
Default GW 2	Comms	14.4.
Default GW 3	Comms	14.4.
Default GW 4	Comms	14.4.
Delay	AnAlm	12.4.
DelayedStart?	Program Setup	22.16.
Deriv OP	Lp Diag	21.9.
Deriv Type	LP Setup	21.4.2.
Dest	Commstab	14.7.
Dest Addr	Comms	14.3.
DewPoint	Humidity	16.2.
DewPoint	Zirconia	16.4.
DgAlm En	Inst Enb	6.3.1.
DHCP enable	Comms	14.4.
Direction	Count	15.1.1.
Disp Hi	PV Input	7.2.
Disp Hi	Lgc IO	8.2.
Disp Hi	Mod	10.3.
Disp Hi/Lo	RlyAA	9.2.
Disp Lo	PV Input	7.2.
Disp Lo	Lgc IO	8.2.
Disp Lo	Mod	10.3.
Disp Stack Free	Inst Dia	6.7.
Div	Math Operators	18.3.1.
DryT	Humidity	16.2.
Duration	Prog Edit Sync All	22.17.1.
Duration	Single Program Edit	22.19.1.
E.CaL	DiagAlms	12.6.
E.Conf	DiagAlms	12.6.
E.Lin	DiagAlms	12.6.
E2.Er	DiagAlms	12.6.
EE.Er	DiagAlms	12.6.
Elapsed Time	Timer	15.2.6.
Emiss	PV Input	7.2.
Enable	Mstrcomms	14.9.2.
Enable	Count	15.1.1.
Enable	Lp Tune	21.6.4.
End of Seg	Program Setup	22.16.
End of Seg	Single Program Edit	22.19.1.
End Type	Prog Edit Sync All	22.17.1.
End Type	Single Program Edit	22.19.1.
Equal	Logic operators	18.1.2.
Equal to or greater than	Logic operators	18.1.2.
Equal to or less than	Logic operators	18.1.2.
ErrMode	SwOver	23.1.2.
Error	Lp Diag	21.9.

Parameter	Location	Section
Error Count	Inst Dia	6.7.
Error Count	Mstrcomms	14.9.2.
Error1	Inst Dia	6.7.
Error2	Inst Dia	6.7.
Error3	Inst Dia	6.7.
Error4	Inst Dia	6.7.
Error5	Inst Dia	6.7.
Error6	Inst Dia	6.7.
Error7	Inst Dia	6.7.
Error8	Inst Dia	6.7.
Event 1 to 8	Program Setup	22.16.
Event 1 to 8	Single Program Edit	22.19.1.
Event Outs	Prog Edit Sync All	22.17.1.
Event Outs	Single Program Edit	22.19.1.
Exception Code	Mstrcomms	14.9.2.
Exception Count	Mstrcomms	14.9.2.
Exp	Math Operators	18.3.1.
Expander Type	IOExp	11.1.1.
Factor	Mstrcomms	14.9.2.
Fall Type	packbit	14.10.1.
Fall Type	unpackbit	14.11.1.
Fall Type	Lgc2	18.1.3.
Fall Type	Lin16	19.1.2.
Fall Type	Poly	19.2.
Fall Type	SwOver	23.1.2.
Fall Value	Lin16	19.1.2.
Fall Value	Poly	19.2.
Fall Value	SwOver	23.1.2.
Fallback	PV Input	7.2.
Fallback	Mod	10.3.
Fallback	packbit	14.10.1.
Fallback	unpackbit	14.11.1.
Fallback	Math9	18.3.2.
Fallback	Mux10	18.4.1.
Fallback	MultiOp	18.5.6.
Fallback PV	PV Input	7.2.
Fallback PV	Mod	10.3.
Fallback Val	Math10	18.3.2.
Fallback Val	Mux11	18.4.1.
Fallback Val	MultiOp	18.5.6.
FF Gain	Lp OP	21.8.1.
FF Offset	Lp OP	21.8.1.
FF OP	Lp OP	21.8.1.
FF Trim Limit	Lp OP	21.8.1.
FF Type	Lp OP	21.8.1.
Filter Time	PV Input	7.2.
Filter Time	Mod	10.3.
ForcedOP	Lp OP	21.8.1.
Format	Mstrcomms	14.9.2.
Function	Mstrcomms	14.9.2.

Parameter	Location	Section
G. Soak Value	Prog Edit Sync Start	22.17.2.
Gain	Load	20.1.
Gas Ref	Zirconia	16.4.
GoBack Cycles	Prog Edit Sync All	22.17.1.
GoBack Seg	Prog Edit Sync All	22.17.1.
Goto	Access	3.2
Greater than	Logic operators	18.1.2.
GSoak Type	Prog Edit Sync Start	22.17.2.
Gsoak?	Program Setup	22.16.
H Activity	Comms	14.3.
H2_InUse	Zirconia	16.4.
H2_Local	Zirconia	16.4.
H2_RemEn	Zirconia	16.4.
H2_Remote	Zirconia	16.4.
Hi Offset	Mod	10.3.
Hi Point	Mod	10.3.
High Limit	Math8	18.3.2.
High Limit	Mux8	18.4.1.
High Limit	UsrVal	25.1.
High Output	Lp Tune	21.6.4.
Hold	Total	15.3.1.
Holdback Type	Prog Edit Sync Start	22.17.2.
Holdback Type	Single Program Edit	22.19.1.
Holdback Value	Prog Edit Sync Start	22.17.2.
Holdback Value	Single Program Edit	22.19.1.
Home Page	Inst Dis	6.5.
Home Timeout	Inst Dis	6.5.
HotSwp	Math Operators	18.3.1.
Humidity En	Inst Enb	6.3.1.
Hyst	AnAlm	12.4.
Ident	Mod	10.3.
Ident	Comms	14.3.
Idle Stack Free	Inst Dia	6.7.
ImmSP?	Inst Opt	6.4.
In	Total	15.3.1.
In 1	BCDIn	12.6.
In 1-10	IOExp	11.1.1.
In 11-20	IOExp	11.1.1.
In 2	BCDIn	12.6.
In 3	BCDIn	12.6.
In 4	BCDIn	12.6.
In 5	BCDIn	12.6.
In 6	BCDIn	12.6.
In 7	BCDIn	12.6.
In 8	BCDIn	12.6.
In High	Lin16	19.1.2.
In High	Poly	19.2.
In Low	Lin16	19.1.2.
In Low	Poly	19.2.
In Status	IPMon	17.2.

Parameter	Location	Section
In Status	MultiOp	18.5.6.
In1	MultiOp	18.5.6.
In1 to 14	Lin16	19.1.2.
In1 to In 20	IOExp	11.1.1.
In1 to In16	packbit	14.10.1.
In1 to In8	Lgc8	18.2.1.
In2	MultiOp	18.5.6.
In3	MultiOp	18.5.6.
In4	MultiOp	18.5.6.
In5	MultiOp	18.5.6.
In6	MultiOp	18.5.6.
In7	MultiOp	18.5.6.
In8	MultiOp	18.5.6.
Inertia	Lgc IO	8.2.
Inertia	Mod	10.3.
Inhibit	AnAlm	12.4.
Inhibit	LP Main	21.3.1.
InOP	Lp Diag	21.9.
Input	AnAlm	12.4.
Input	unpackbit	14.11.1.
Input	Timer	15.2.6.
Input	IPMon	17.2.
Input	Lin16	19.1.2.
Input	Poly	19.2.
Input 1	SwOver	23.1.2.
Input 2	SwOver	23.1.2.
Input Hi	SwOver	23.1.2.
Input Hi	Txdr	24.6.
Input Lin	Poly	19.2.
Input Lo	SwOver	23.1.2.
Input Lo	Txdr	24.6.
Input Value	Txdr	24.6.
Input1	Lgc2	18.1.3.
Input1 Scale	Math3	18.3.2.
Input1 to 8	Mux13	18.4.1.
Input1 Value	Math11	18.3.2.
Input2	Lgc2	18.1.3.
Input2 Scale	Math4	18.3.2.
Input2 Value	Math12	18.3.2.
Inst Type	Inst Inf	6.6.
IntHold	LP Main	21.3.1.
Inv21-30	IOExp	11.1.1.
Inv31-40	IOExp	11.1.1.
Invert	Lgc IO	8.2.
Invert	RlyAA	9.2.
Invert	Mod	10.3.
Invert	Lgc2	18.1.3.
Invert	Lgc8	18.2.1.
IO Exp En	Inst Enb	6.3.1.

Parameter	Location	Section
IO Type	PV Input	7.2.
IO Type	Lgc IO	8.2.
IO Type	RlyAA	9.2.
IO Type	Mod	10.3.
IP Address 1	Comms	14.4.
IP Address 2	Comms	14.4.
IP Address 3	Comms	14.4.
IP Address 4	Comms	14.4.
IP Mon En	Inst Enb	6.3.1.
IR Mode	Access	3.2
Keylock	Access	3.2
Language	Inst Dis	6.5.
LastCln	Zirconia	16.4.
Latch	AnAlm	12.4.
LATCH	Logic operators	18.1.2.
LBT/LBT2/LBT3	Lp PID	21.5.1.
Lead Res	PV Input	7.2.
Less than	Logic operators	18.1.2.
Level2 Code	Access	3.2
Level3 Code	Access	3.2
Lgc2 En1/En2/En3	Inst Enb	6.3.1.
Lgc8 En	Inst Enb	6.3.1.
Lin Type	PV Input	7.2.
Lin Type	Mod	10.3.
Lin16Pt En	Inst Enb	6.3.1.
Ln	Math Operators	18.3.1.
Lo Offset	Mod	10.3.
Lo Point	Mod	10.3.
Load En	Inst Enb	6.3.1.
Load Res	Mod	10.3.
Log	Math Operators	18.3.1.
Loop 1 Summary	Inst Dis	6.5.
Loop 2 Summary	Inst Dis	6.5.
Loop En	Inst Enb	6.3.1.
Loop Mode	Lp Diag	21.9.
Loop Name	LP Setup	21.4.2.
Loop Summary	Inst Dis	6.5.
LoopOP CH1	Load	20.1.
LoopOP CH2	Load	20.1.
Low Limit	Math7	18.3.2.
Low Limit	Mux9	18.4.1.
Low Limit	UsrVal	25.1.
Low Output	Lp Tune	21.6.4.
LowerKey	Access	3.2
Lp Break	Lp Diag	21.9.
Main Bar Val	Inst Dis	6.5.
Man Mode	Lp OP	21.8.1.
Man Track	Lp SP	21.7.1.
ManOP	Lp OP	21.8.1.
Manual Startup	Lp OP	21.8.1.

Parameter	Location	Section
Math2 En1/En2/En3	Inst Enb	6.3.1.
Max	IPMon	17.2.
Max Con Tick	Inst Dia	6.7.
Max Events	Program Setup	22.16.
Max Events	Single Program Edit	22.19.1.
Max Out	MultiOp	18.5.6.
Max UI Ticks	Inst Dia	6.7.
Max.Inst Segs	Inst Dia	6.7.
MaxRcvTim	Zirconia	16.4.
Meas Val	Lgc IO	8.2.
Meas Val	RlyAA	9.2.
Meas Value	PV Input	7.2.
Meas Value	Mod	10.3.
Meas Value	Mod	10.3.
Min	IPMon	17.2.
Min OnTime	Lgc IO	8.2.
Min OnTime	RlyAA	9.2.
Min OnTime	Mod	10.3.
Min Out	MultiOp	18.5.6.
MinCalcTp	Zirconia	16.4.
MinCalcTp	Zirconia	16.4.
MinRcvTim	Zirconia	16.4.
Minutes	Commstab	14.7.
Mode	Mstrcomms	14.9.2.
Mode	RTClock	15.4.1.
MR/MR2/MR3	Lp PID	21.5.1.
Mul	Math Operators	18.3.1.
MultiOper En	Inst Enb	6.3.1.
Mux8 En	Inst Enb	6.3.1.
Native	Commstab	14.7.
Network	Comms	14.3.
Network	Comms	14.4.
Node	Mstrcomms	14.9.2.
Noise	Load	20.1.
Not equal	Logic operators	18.1.2.
Nudge Lower	Lp OP	21.8.1.
Nudge Raise	Lp OP	21.8.1.
Num In	MultiOp	18.5.6.
Num Sets	Lp PID	21.5.1.
Num Valid In	MultiOp	18.5.6.
NumIn	Lgc8	18.2.1.
Off Day1	RTClock	15.4.1.
Off Day2	RTClock	15.4.1.
Off Time	Prog Edit Sync All	22.17.1.
Off Time1	RTClock	15.4.1.
Off Time2	RTClock	15.4.1.
Offset	PV Input	7.2.
Offset	Mstrcomms	14.9.2.
Offset	Load	20.1.
On Day1	RTClock	15.4.1.

Parameter	Location	Section
On Day2	RTClock	15.4.1.
On Time	Prog Edit Sync All	22.17.1.
On Time1	RTClock	15.4.1.
On Time2	RTClock	15.4.1.
OP1 Beacon	Inst Dis	6.5.
OP2 Beacon	Inst Dis	6.5.
Oper	Lgc2	18.1.3.
Oper	Lgc8	18.2.1.
Operation	Math2	18.3.2.
OPHi/2/3	Lp PID	21.5.1.
OPLo/2/3	Lp PID	21.5.1.
OR	Logic operators	18.1.2.
Out	Lgc8	18.2.1.
Out Hi Limit	MultiOp	18.5.6.
Out High	Lin16	19.1.2.
Out High	Poly	19.2.
Out Invert	Lgc8	18.2.1.
Out Lo Limit	MultiOp	18.5.6.
Out Low	Lin16	19.1.2.
Out Low	Poly	19.2.
Out Res'n	Lin16	19.1.2.
Out1	RTClock	15.4.1.
Out1 to 14	Lin16	19.1.2.
Out1 to Out 16	unpackbit	14.11.1.
Out2	RTClock	15.4.1.
Out21 to Out 40	IOExp	11.1.1.
Out21-30	IOExp	11.1.1.
Out31-40	IOExp	11.1.1.
Output	AnAlm	12.4.
Output	packbit	14.10.1.
Output	Timer	15.2.6.
Output	Lgc2	18.1.3.
Output	Mux14	18.4.1.
Output	Lin16	19.1.2.
Output	Poly	19.2.
Output Hi	Lp OP	21.8.1.
Output Lo	Lp OP	21.8.1.
Output Res'n	Math6	18.3.2.
Output Status	Txdr	24.6.
Output Units	Math5	18.3.2.
Output Value	Math13	18.3.2.
Output Value	Txdr	24.6.
Overflow	Count	15.1.1.
Oxygen	Zirconia	16.4.
OxygenExp	Zirconia	16.4.
OxygenTyp	Zirconia	16.4.
PackBitEn	Inst Enb	6.3.1.
Page Key	Access	3.2
Parity	Comms	14.3.
Passcode1	Inst Inf	6.6.

Parameter	Location	Section
Passcode2	Inst Inf	6.6.
Passcode3	Inst Inf	6.6.
PB Units	LP Setup	21.4.2.
PB/PB2/PB3	Lp PID	21.5.1.
Pff En	Lp OP	21.8.1.
PID Set	Prog Edit Sync All	22.17.1.
PID Set?	Program Setup	22.16.
Poly En	Inst Enb	6.3.1.
Port	Mstrcomms	14.9.2.
PotBrk Mode	Lp OP	21.8.1.
PotCal	Lp OP	21.8.1.
Power	Math Operators	18.3.1.
Power Fail	Program Setup	22.16.
Power Fail	Single Program Edit	22.19.1.
Power FF	Inst Dia	6.7.
PrbState	Zirconia	16.4.
Pref mstr IP 1	Comms	14.4.
Pref mstr IP 2	Comms	14.4.
Pref mstr IP 3	Comms	14.4.
Pref mstr IP 4	Comms	14.4.
Pressure	Humidity	16.2.
Prg 1 or 2	Prog Edit Sync Start	22.17.2.
PrgIn1	Program Setup	22.16.
PrgIn2	Program Setup	22.16.
Priority	AnAlm	12.4.
Probe Type	Zirconia	16.4.
ProbeFlt	Zirconia	16.4.
ProbeFlt	Zirconia	16.4.
ProbelP	Zirconia	16.4.
ProbeOffs	Zirconia	16.4.
ProbeStat	Zirconia	16.4.
ProcFact	Zirconia	16.4.
Prog Edit	Inst Dis	6.5.
Prog Hold	Program Setup	22.16.
Prog Hold	Single Program Edit	22.19.1.
Prog Key	Access	3.2
Prog Key	Inst Dia	6.7.
Prog Reset	Program Setup	22.16.
Prog Reset	Single Program Edit	22.19.1.
Prog Run	Program Setup	22.16.
Prog Run	Single Program Edit	22.19.1.
Prog RunHold	Program Setup	22.16.
Prog RunReset	Program Setup	22.16.
Prog Summary	Inst Dis	6.5.
ProgError	Program Setup	22.16.
ProgMode	Inst Opt	6.4.
Progr En	Inst Enb	6.3.1.
Program	Prog Edit Sync All	22.17.1.
Program	Prog Edit Sync Start	22.17.2.
Prop OP	Lp Diag	21.9.

Parameter	Location	Section
Protocol	Comms	14.3.
PsycK	Humidity	16.2.
PV	PV Input	7.2.
PV	Lgc IO	8.2.
PV	RlyAA	9.2.
PV	Mod	10.3.
PV	Mod	10.3.
PV	LP Main	21.3.1.
PV Event	Prog Edit Sync Start	22.17.2.
PV Input	Program Setup	22.16.
PV Input	Single Program Edit	22.19.1.
PV Out1	Load	20.1.
PV Out2	Load	20.1.
PV Start	Prog Edit Sync Start	22.17.2.
PV Threshold	Prog Edit Sync Start	22.17.2.
PV Wait	Prog Edit Sync Start	22.17.2.
PVEvent?	Program Setup	22.16.
PVEventOP	Program Setup	22.16.
PVFault	Load	20.1.
PVFrozen	Zirconia	16.4.
PVFrozen	Zirconia	16.4.
PVStart?	Inst Opt	6.4.
PVWaitIP	Program Setup	22.16.
Pwr Fail Count	Inst Dia	6.7.
Pwr In	Lp OP	21.8.1.
R2G/R2G2/	Lp PID	21.5.1.
R2G3	Lp PID	21.5.1.
RaiseKey	Access	3.2
Ramp Rate	Prog Edit Sync Start	22.17.2.
Ramp Rate	Single Program Edit	22.19.1.
Ramp Units	Prog Edit Sync Start	22.17.2.
Ramp Units	Single Program Edit	22.19.1.
Range Hi	PV Input	7.2.
Range Hi	Lgc IO	8.2.
Range Hi	Mod	10.3.
Range Hi	Lp SP	21.7.1.
Range Hi/Lo	RlyAA	9.2.
Range Lo	PV Input	7.2.
Range Lo	Lgc IO	8.2.
Range Lo	Mod	10.3.
Range Lo	Lp SP	21.7.1.
Range Max	Txdr	24.6.
Range Min	Txdr	24.6.
Rate	Lp SP	21.7.1.
Rate	Lp OP	21.8.1.
Rate Res	Program Setup	22.16.
RateDone	Lp SP	21.7.1.
ReadOnly	Commstab	14.7.
Reference	AnAlm	12.4.
RelHumid	Humidity	16.2.



Parameter	Location	Section
RemOPH	Lp OP	21.8.1.
RemOPL	Lp OP	21.8.1.
Remote Input	Lp PID	21.5.1.
Res	Poly	19.2.
Res'n	PV Input	7.2.
Res'n	Total	15.3.1.
Res'n	Humidity	16.2.
Res'n	Mux16	18.4.1.
Res'n	MultiOp	18.5.6.
Res'n	Load	20.1.
Res'n	UsrVal	25.1.
Reset	Count	15.1.1.
Reset	Total	15.3.1.
Reset	IPMon	17.2.
Res'n	Mod	10.3.
Resol'n	Zirconia	16.4.
Resolution	Comms	14.3.
Resolution	Program Setup	22.16.
Ripple Carry	Count	15.1.1.
RTClock En	Inst Enb	6.3.1.
Run	Total	15.3.1.
Run/Hold Func	Access	3.2
Run/Hold Key	Access	3.2
Run/Hold Key	Inst Dia	6.7.
Safe OP	Lp OP	21.8.1.
SBreak	Humidity	16.2.
SBrk Alarm	PV Input	7.2.
Sbrk Mode	Lp OP	21.8.1.
Sbrk OP	Lp OP	21.8.1.
SBrk Type	PV Input	7.2.
SBrk Type	Mod	10.3.
SBrk Value	PV Input	7.2.
SBrk Value	Mod	10.3.
SBrkAlarm	Mod	10.3.
SBrkOut	Mod	10.3.
SbyAct	Lgc IO	8.2.
SbyAct	RlyAA	9.2.
SbyAct	Mod	10.3.
Scale Hi	Txdr	24.6.
Scale Lo	Txdr	24.6.
Sched CBH	Lp Diag	21.9.
Sched CBL	Lp Diag	21.9.
Sched LpBrk	Lp Diag	21.9.
Sched MR	Lp Diag	21.9.
Sched OPHi	Lp Diag	21.9.
Sched OPLo	Lp Diag	21.9.
Sched PB	Lp Diag	21.9.
Sched R2G	Lp Diag	21.9.
Sched Td	Lp Diag	21.9.

Parameter	Location	Section
Sched Ti	Lp Diag	21.9.
Sched Type	Lp PID	21.5.1.
Scroll Key	Access	3.2
Segment	Prog Edit Sync All	22.17.1.
Segment	Single Program Edit	22.19.1.
Segment Type	Prog Edit Sync All	22.17.1.
Segment Type	Single Program Edit	22.19.1.
Segments Left	Inst Dia	6.7.
Segments Used	Prog Edit Sync All	22.17.1.
Segments Used	Single Program Edit	22.19.1.
Segs Per Prog	Inst Dia	6.7.
Select	Math Operators	18.3.1.
Select	Mux12	18.4.1.
Selected IP	SwOver	23.1.2.
SelMax	Math Operators	18.3.1.
SelMin	Math Operators	18.3.1.
SensorB	Lp Diag	21.9.
Serial Num	Inst Inf	6.6.
Servo	Program Setup	22.16.
Servo	Single Program Edit	22.19.1.
ServoToPV	Lp SP	21.7.1.
Show MAC	Comms	14.4.
Shunt	Mod	10.3.
Shunt State	Txdr	24.6.
SkipSeg	Program Setup	22.16.
SivData1 to SivData16	Mstrcomms	14.9.2.
SmpHld	Math Operators	18.3.1.
SootAlm	Zirconia	16.4.
Source	Commstab	14.7.
SP HighLim	Lp SP	21.7.1.
SP Input	Program Setup	22.16.
SP Input	Single Program Edit	22.19.1.
SP LowLim	Lp SP	21.7.1.
SP Select	Lp SP	21.7.1.
SP Track	Lp SP	21.7.1.
SP Trim	Lp SP	21.7.1.
SP Trim Hi	Lp SP	21.7.1.
SP Trim Lo	Lp SP	21.7.1.
SP1	Lp SP	21.7.1.
SP2	Lp SP	21.7.1.
SPRate Disable	Lp SP	21.7.1.
Sqrt	Math Operators	18.3.1.
Stage	Lp Tune	21.6.4.
Stage Time	Lp Tune	21.6.4.
Standby	Access	3.2
Start Cal	Txdr	24.6.
Start Hi Cal	Txdr	24.6.
Start Tare	Txdr	24.6.
State	Lp Tune	21.6.4.

Parameter	Location	Section
Status	PV Input	7.2.
Status	Mod	10.3.
Status	IOExp	11.1.1.
Status	packbit	14.10.1.
Status	unpackbit	14.11.1.
Status	Lgc2	18.1.3.
Status	Math14	18.3.2.
Status	Mux15	18.4.1.
Status	Lin16	19.1.2.
Status	Poly	19.2.
Status	SwOver	23.1.2.
Status	UsrVal	25.1.
String Count	Inst Dia	6.7.
String Space	Inst Dia	6.7.
Sub	Math Operators	18.3.1.
Subnet mask 1	Comms	14.4.
Subnet mask 2	Comms	14.4.
Subnet mask 3	Comms	14.4.
Subnet mask 4	Comms	14.4.
Success Count	Mstrcomms	14.9.2.
Sum Out	MultiOp	18.5.6.
Susp Retry	Mstrcomms	14.9.2.
Suspend Count	Mstrcomms	14.9.2.
Suspend Exceed	Mstrcomms	14.9.2.
Switch	Inst Enb	6.3.1.
Switch Hi	SwOver	23.1.2.
Switch Lo	SwOver	23.1.2.
Switch PV	SwOver	23.1.2.
SwOver En	Inst Enb	6.3.1.
Sync Input	Program Setup	22.16.
Sync Input	Single Program Edit	22.19.1.
Sync1	Program Setup	22.16.
SyncMode	Single Program Edit	22.19.1.
Tare Value	Txdr	24.6.
Target	Count	15.1.1.
Target OP	Lp Diag	21.9.
Target SP	LP Main	21.3.1.
Target SP	Prog Edit Sync Start	22.17.2.
Target SP	Single Program Edit	22.19.1.
TC1	Load	20.1.
TC2	Load	20.1.
Td/Td2/Td3	Lp PID	21.5.1.
TempInput	Zirconia	16.4.
TempOffs	Zirconia	16.4.
Tens	BCDIn	12.6.
Threshold	AnAlm	12.4.
Threshold	IPMon	17.2.
Ti/Ti2/Ti3	Lp PID	21.5.1.
Time	Timer	15.2.6.

Parameter	Location	Section
Time	RTClock	15.4.1.
Time Above	IPMon	17.2.
Time Event	Prog Edit Sync All	22.17.1.
Time2CIn	Zirconia	16.4.
TimeEvent?	Program Setup	22.16.
Timeout	Comms	14.9.2.
Timer En	Inst Enb	6.3.1.
Tolerance	Zirconia	16.4.
Total	Total	15.3.1.
Totalise En	Inst Enb	6.3.1.
Track En	Lp OP	21.8.1.
Track OP	Lp OP	21.8.1.
Track PV	Lp SP	21.7.1.
Track SP	Lp SP	21.7.1.
Transact Count	Mstrcomms	14.9.2.
Triggered	Timer	15.2.6.
TrScale En	Inst Enb	6.3.1.
Txdr1 Page	Inst Dis	6.5.
Txdr2 Page	Inst Dis	6.5.
Type	AnAlm	12.4.
Type	Timer	15.2.6.
Type	Load	20.1.
UI Stack Free	Inst Dia	6.7.
UI Ticks	Inst Dia	6.7.
Unit Ident	Comms	14.4.
Units	Inst Opt	6.4.
Units	PV Input	7.2.
Units	Mod	10.3.
Units	BCDIn	12.6.
Units	Total	15.3.1.
Units	MultiOp	18.5.6.
Units	Lin16	19.1.2.
Units	Poly	19.2.
Units	Load	20.1.
Units	Program Setup	22.16.
Units	UsrVal	25.1.
UnpackBitEn	Inst Enb	6.3.1.
UserVal?	Program Setup	22.16.
UserValOP	Program Setup	22.16.
UsrVal	Prog Edit Sync All	22.17.1.
UsrVal En1	Inst Enb	6.3.1.
UsrVal En2	Inst Enb	6.3.1.
Value	UsrVal	25.1.
Version Num	Inst Inf	6.6.
Voltage	Mod	10.3.
Wait For	Prog Edit Sync All	22.17.1.
WaitVal	Prog Edit Sync Start	22.17.2.
Wdog Action	Comms	14.3.
Wdog Flag	Comms	14.3.

---

<b>Parameter</b>	<b>Location</b>	<b>Section</b>
Wdog Timeout	Comms	14.3.
WdogRecy	Comms	14.3.
WetOfs	Humidity	16.2.
WetT	Humidity	16.2.
Work OP	LP Main	21.3.1.
Wrk OPHi	Lp Diag	21.9.
Wrk OPLo	Lp Diag	21.9.
Wrk Gas	Zirconia	16.4.
WSP	LP Main	21.3.1.
XOR	Logic operators	18.1.2.
ZirconiaEn	Inst Enb	6.3.1.



This page is intentionally blank

**Contact Information**

**Eurotherm Head Office**

Faraday Close,  
Durrington,  
Worthing, West Sussex,  
BN13 3PL

**Sales Enquiries**

T +44 (01903) 695888  
F 0845 130 9936

**General Enquiries**

T +44 (01903) 268500  
F 0845 265982

**Worldwide Offices**

[www.eurotherm.com/global](http://www.eurotherm.com/global)



Scan for local contacts

*Represented by:*

© Copyright Eurotherm Limited 2015

Eurotherm by Schneider Electric, the Eurotherm logo, Chessell, EurothermSuite, Mini8, Eycon, Eyriss, EPower, EPack, nanodac, piccolo, versadac, optivis, Foxboro and Wonderware are trademarks of Schneider Electric, its subsidiaries and affiliates. All other brands may be trademarks of their respective owners. All rights are strictly reserved. No part of this document may be reproduced, modified, or transmitted in any form by any means, nor may it be stored in a retrieval system other than for the purpose to act as an aid in operating the equipment to which the document relates, without the prior written permission of Eurotherm Limited. Eurotherm Limited pursues a policy of continuous development and product improvement. The specifications in this document may therefore be changed without notice. The information in this document is given in good faith, but is intended for guidance only. Eurotherm Limited will accept no responsibility for any losses arising from errors in this document.