

# **CURRENT SENSORS**

**WITH MAGNETIC FIELD PROBE**  
**INDUSTRIAL APPLICATIONS**

ADVANCED MATERIALS – THE KEY TO PROGRESS

**VAC**  
VACUUMSCHMELZE

# CURRENT SENSORS WITH MAGNETIC FIELD PROBE INDUSTRIAL APPLICATIONS

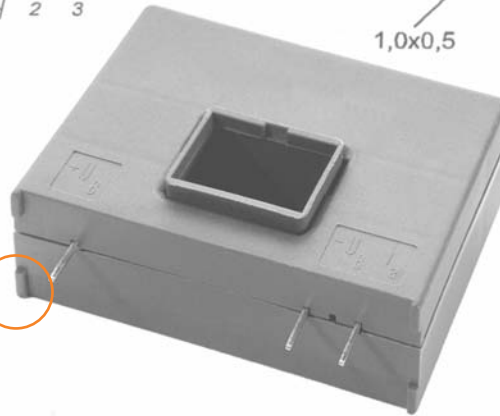
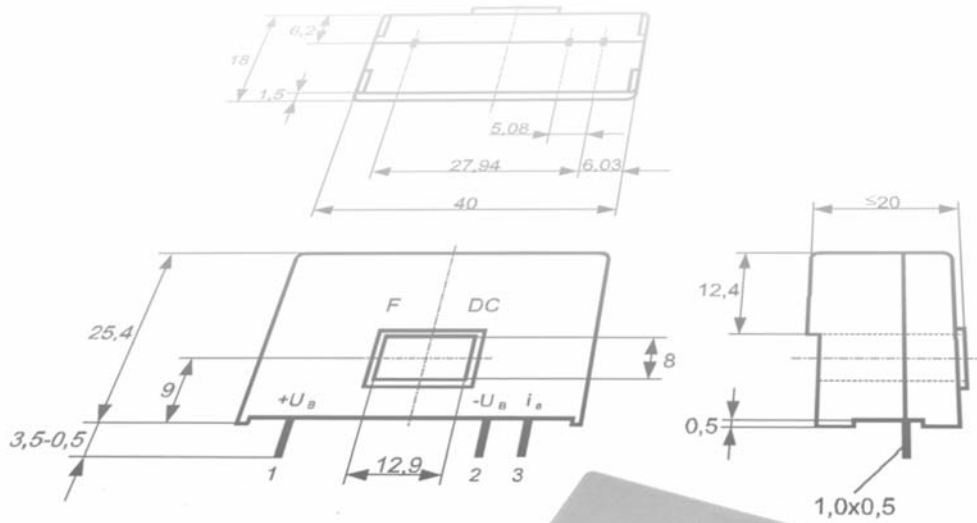

## 1. PREFACE

This brochure covers the standard current sensor range of VACUUMSCHMELZE GmbH & Co. KG (VAC) for the floating measurement of currents. Customized solutions are available on request.

VAC customers benefit from our comprehensive knowledge along the entire process chain. It starts with the material properties and goes over the dimensioning, the production technology and organization up to the world-wide procurement of purchased parts. VAC has decades of experience in the development, manufacturing and application of current sensors.

VAC current sensors apply in lowest up to high performance classes both in industry and in automotive applications:

- three phases drives, servo drives, generators
- power converters for DC drives
- battery operated applications
- uninterruptible power supplies
- switched mode power supplies
- welding inverters
- battery energy management

Our sensors are developed according to strictest international standards. Some types are UL approved. We also possess worldwide ISO 9001:2000 qualification.

## 2. TECHNOLOGIES

For current measurement, the market offers different technologies, like open- and closed loop hall effect sensors with galvanic separation, or shunts without galvanic separation.

As the only manufacturer worldwide, VAC offers current sensors, which use a soft-magnetic probe in place of the hall generator as the magnetic field detector. In relation to conventional hall effect compensation sensors, our products offer some advantages:

- very low offset current with negligible long-term drift
- practically no temperature dependence of the offset current
- very small hysteresis of the offset current
- high usable temperature range (e.g. up to 110 °C in an IGBT module)
- the magnetic module can be separated from the electronics
- no electronics adjustment necessary
- attractively priced

### 3. FUNCTIONAL PRINCIPLE OF VAC CURRENT SENSORS

Two major advantages of the compensation current sensors are their principle-related high linearity and their excellent dynamic properties. The current  $I_p$  to be measured is magnetically coupled to the compensation current through a soft magnetic core. The magnetic flux of this core is measured by a magnetic field detector and controlled to zero by the electronics, generating a compensation current  $I_s$  in the compensation winding. This current is proportional to the primary current  $I_p$ .

When using a Hall generator as the magnetic field detector, which is the common method, an offset voltage and the associated drift occurs. For this reason VAC has developed a sensor using a low-drift soft magnetic metallic field detector. This has made it possible to reduce the offset current and its drift considerably. A smoother run of inverter-controlled motors even at low torque operation is the result. This preserves the bearings, prolongs the service life and leads to higher accuracy, especially in machine tools.

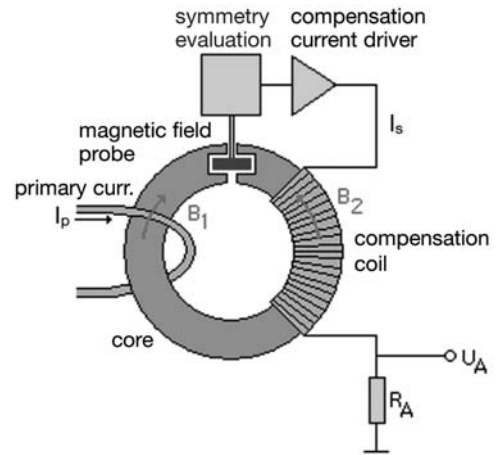

The type range of the VAC sensors offers a suitable solution for every current range and performance class.





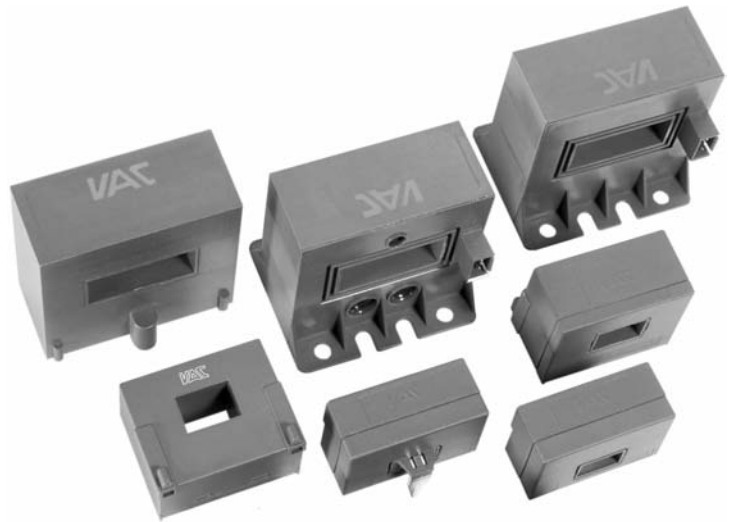



The current sensors presented here are designed for the use in appliances and systems in stationary operation. In the case of traction – or automotive – applications please contact us.

Class	Power [kW]	$I_{N, rms}$ [A]	$I_{Npl}$ [A]
Micro	$\leq 4$	$\leq 12$	$\leq 30$ $\leq 42$
Low-End	$> 4 \dots \leq 40$	$> 12 \dots \leq 105$	$> 30 \dots \leq 260$ $> 42 \dots \leq 370$
Midrange	$> 40 \dots \leq 200$	$> 105 \dots \leq 430$	$> 260 \dots \leq 1.075$ $> 370 \dots \leq 1.505$
High End	$> 200 \dots \leq 600$	$> 430 \dots \leq 1.080$	$> 1.075 \dots \leq 2.700$ $> 1.505 \dots \leq 3.780$
Mega	$> 600$	$> 1.080 \dots \leq 1.600$	$> 2.700 \dots \leq 4.000$ $> 3.780 \dots \leq 5.600$















## 4. TYPE RANGE

### 4.1 ACTIVE SCURRENT SENSORS (with integrated electronics)

Partnumber Type T60404-N ...	$I_{PN, rms}$ [A]	$I_{P, max}$ [A]	$T_A$ [°C]	$V_C$ [V]	$K_N$	f [kHz]	X @ $I_{PN}$ , $T_A=25^\circ\text{C}$ [%]	Primary connection		Secondary connection		Integrated electronics	Potted	Incapaculated	Screw-on mounting	Drawing
								Pins	Centre hole for cable or bus bar	Pins	Connector					
	4644-X300	1-5-8-12-25	10-17-25-50	-40 ... +85	$\pm 15\text{ V}$	(1...5):1000	DC...200	0,5	•	•	•	•				7
		1-5-8-12-30	10-17-25-64	-40 ... +70												
		1-5-8-12-50	10-17-25-64	-40 ... +50												
	4644-X400	7,5-15-30	23-46-92	-40 ... +85	$\pm 15\text{ V}$	(1...4):2000	DC...100	0,5	•	•	•	•				8
		7,5-15-40	23-46-92	-40 ... +70												
		7,5-15-54	23-46-92	-40 ... +50												
	4644-X101	50	150	-40 ... +85	$\pm 15\text{ V}$	1 : 2000	DC...100	0,5	•	•	•	•				3
		100	150	-40 ... +70												
		120	150	-40 ... +55												
	4644-X100	50	70	-40 ... +85	$\pm 15\text{ V}$	1 : 1000	DC...100	0,5	•	•	•	•				3
		50	92	-40 ... +70												
	4644-X111	50	150	-40 ... +85	$\pm 15\text{ V}$	1 : 2000	DC...100	0,5	•	•	•	•				4
		100	150	-40 ... +70												
		120	150	-40 ... +55												
	4644-X112	50	70	-40 ... +85	$\pm 15\text{ V}$	1 : 1000	DC...100	0,5	•	•	•	•				4
		50	92	-40 ... +70												
	4644-X201	125	350	-40 ... +85	$\pm 15\text{ V}$	1 : 2000	DC...100	0,5	•	•	•	•				5
		200	300	-40 ... +85												
		200	350	-40 ... +70												
		250	350	-40 ... +55												
	4644-X200	125	200	-40 ... +70	$\pm 15\text{ V}$	1 : 1000	DC...100	0,5	•	•	•	•				5
		125	175	-40 ... +85												
	4644-X202	125	200	-40 ... +70	$\pm 15\text{ V}$	1 : 1000	DC...100	0,5	•	•	•	•				5
		125	175	-40 ... +85												

 = preferred type





Partnumber Type T60404-N ...	$I_{PN, rms}$ [A]	$I_{P, max}$ [A]	$T_A$ [°C]	$V_C$ [V]	$K_N$	f [kHz]	X @ $I_{PN}$ , $T_A=25^\circ\text{C}$ [%]	Primary connection		Secondary connection		Integrated electronics	Potted	Incapsulated	Screw-on mounting	Drawing
								Pins	Centre hole for cable or bus bar	Pins	Connector					
 4644-X271	125 200 200 250	350 300 350 350	-40 ... +85 -40 ... +85 -40 ... +70 -40 ... +55	±15 V	1 : 2000	DC...100	0,5		•	•		•		•		6
 4644-X052	250 400 500 200 320 400	700 700 700 560 560 560	-40 ... +105 -40 ... +85 -40 ... +70 -40 ... +105 -40 ... +85 -40 ... +70	±15 V   ±12 V	1 : 2000	DC...50	0,5		•		•		•	•		2
 4644-X053	250 400 500 200 320 400	700 700 700 560 560 560	-40 ... +105 -40 ... +85 -40 ... +70 -40 ... +105 -40 ... +85 -40 ... +70	±15 V   ±12 V	1 : 2000	DC...50	0,5		•		•		•	•		2
 4644-X020	200	400	-40 ... +70	±15 V	1 : 2000	DC...50	0,5		•	•		•		•		1
 4644-X021	200	300	-40 ... +85	±15 V	1 : 4000	DC...30	0,5		•	•		•		•		1
 4644-X031	200	300	-40 ... +85	±15 V	1 : 4000	DC...30	0,5		•		•		•	•		2
 4644-X030	200	400	-40 ... +70	±15 V	1 : 2000	DC...50	0,5		•		•		•	•		2
 4644-X050	400 320	425 340	-40 ... +85 -40 ... +85	±15 V ±12 V	1 : 5000	DC...50	0,5		•		•		•	•		2
 4644-X040	400 320	625 500	-40 ... +85 -40 ... +85	±15 V ±12 V	1 : 5000	DC...50	0,5		•		•		•	•		2
 4644-X060	400 320	625 500	-40 ... +85 -40 ... +85	±15 V ±12 V	1 : 5000	DC...50	0,5		•		•		•	•		2
 4644-X055	250 400 500 200 320 400	700 700 700 560 560 560	-40 ... +105 -40 ... +85 -40 ... +70 -40 ... +105 -40 ... +85 -40 ... +70	+15 V   +12 V	1 : 2000	DC...50	0,5		•		•		•	•		2
 4644-X056	500	1000	-40 ... +75	± 24 V	1 : 3000	DC...50	0,5		•		•		•	•		2
 4644-X054	250 400 700 200 320 400	1250 1250 1250 1000 1000 1000	-40 ... +105 -40 ... +85 -40 ... +70 -40 ... +105 -40 ... +85 -40 ... +70	±15 V   ±12 V	1 : 3000	DC...50	0,5		•		•		•	•		2

 EMERGENCY

## 4.2 PASSIVE CURRENT SENSORS

(with separated electronics)







Partnumber Type T60404-M ...	$I_{PN, rms}$	$I_{Pmax}$	$T_A$	$V_C$	$K_N$	$f$	$X$ @ $I_{PN}$ $T_A=25^\circ C$	Primary connection		Secondary connection		Electronics			Potted	Incapsulated	Screw-on mounting	Crawling		
								Pins	Centre hole for cable or bus bar	Pins	Connector	Integrated	Separated	Number						
														One phase					Two phases	Three phases
	4645-X010	3-6-10-20 6-12-20-40	27 60	-40 ... +85	+5 V $\pm 15$ V	(1...6):1000	DC...100	0,5	•	•	•	1,4	2	3	•	•	9			
	4645-X011	6-12-20-40	55	-40 ... +85	$\pm 15$ V	(1...6):3000	DC...100	0,5	•	•	•	1	2	3	•	•	9			
	4645-X012	6-12-20-40	60	-40 ... +85	$\pm 15$ V	(1...6):1000	DC...100	0,5	•	•	•	1	2	3	•	•	9			
	4645-X211	10-16-25-50	90	-40 ... +85	+5 V	(1...5):1000	DC...100	0,5	•	•	•	4			•	•	11			
	4645-X050	100	160	-40 ... +85	$\pm 15$ V	1 : 1000	DC...100	0,5	•	•	•	1	2	3	•	•	10			
	4645-X051	100	142	-40 ... +85	$\pm 15$ V	1 : 2000	DC...100	0,5	•	•	•	1	2	3	•	•	10			
	4645-X070	200	400	-40 ... +85	$\pm 15$ V	1 : 2000	DC...50	0,5	•	•	•	1	2	3	•	•	1			
	4645-X072	200	400	-40 ... +85	$\pm 15$ V	1 : 3000	DC...30	0,5	•	•	•	1	2	3	•	•	1			

 = preferred type

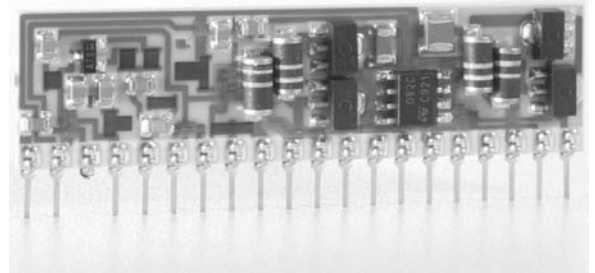
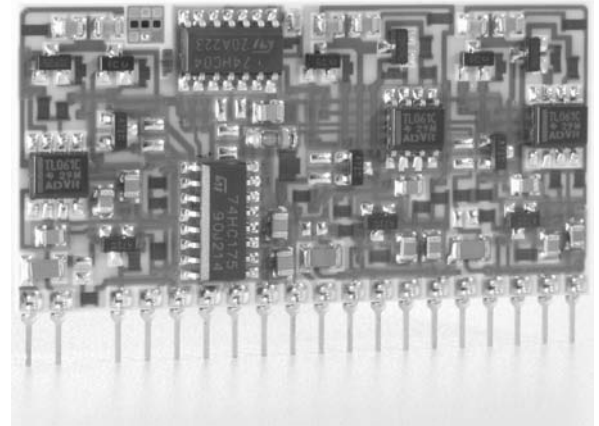
### 4.3 ELECTRONICS

(for passive current sensors)

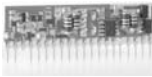

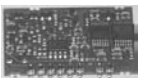
Partnumber Type T60404-Q ...		connectable magnetic modules	$I_c$ [mA]	$V_c$ [V]	$P_{VE0}$ [mW]	$P_{VE, max}$ [W]	Number
	5790-X013	1	14	$\pm 15\text{ V} \pm 5\%$	420	1	1
	5790-X023	2	19	$\pm 15\text{ V} \pm 5\%$	570	1	2
	5790-X101	3	50	$\pm 15\text{ V} \pm 5\%$	750	2	3
	5790-X052	1	35	$+5\text{ V} \pm 5\%$	175		4



## 4.4 DIMENSIONAL DIAGRAMS OF SENSORS

Drawing No. 1

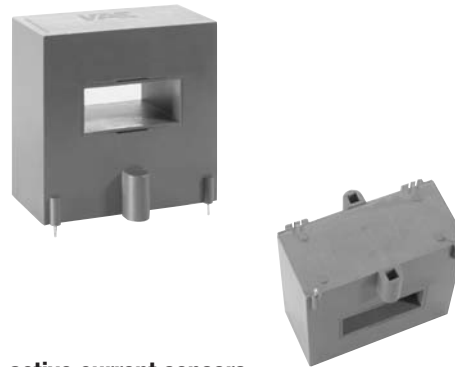
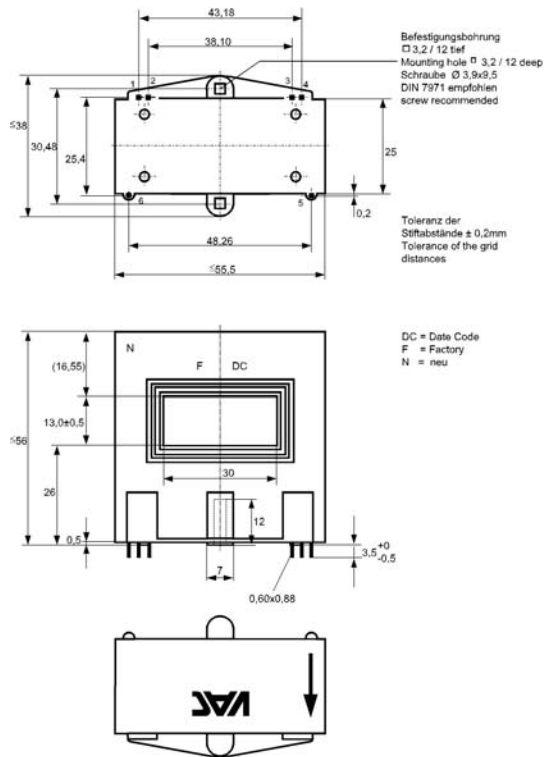

**active current sensors:**

- T60404-N4644-X020
- T60404-N4644-X021

**passive current sensors:**

- T60404-M4645-X070
- T60404-M4645-X072

Drawing No. 2

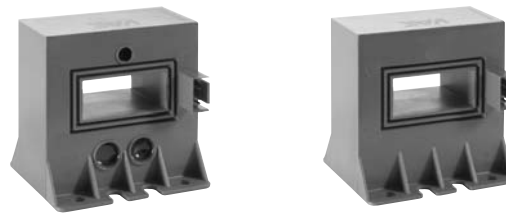
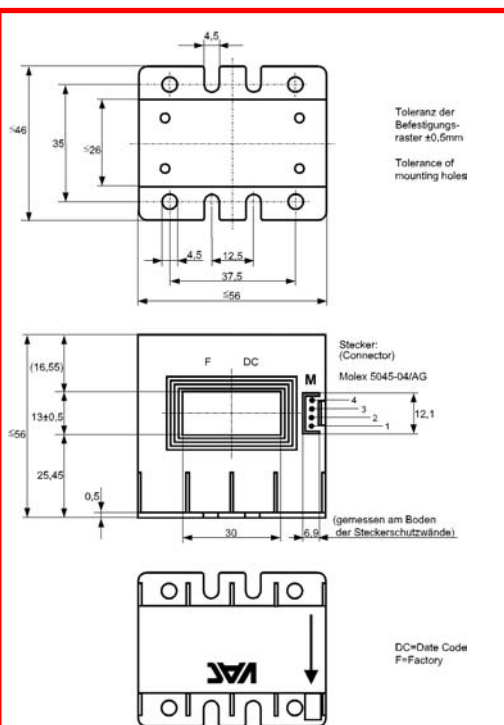

potted version

encapsulated version

**active current sensors:**

- T60404-N4644-X053
- T60404-N4644-X054
- T60404-N4644-X055
- T60404-N4644-X056

**active current sensors:**

- T60404-N4644-X052
- T60404-N4644-X030
- T60404-N4644-X031
- T60404-N4644-X040
- T60404-N4644-X050
- T60404-N4644-X051
- T60404-N4644-X060

**passive current sensors:**

not available in this casing

#### 4.4 DIMENSIONAL DIAGRAMS OF SENSORS

Drawing No. 3

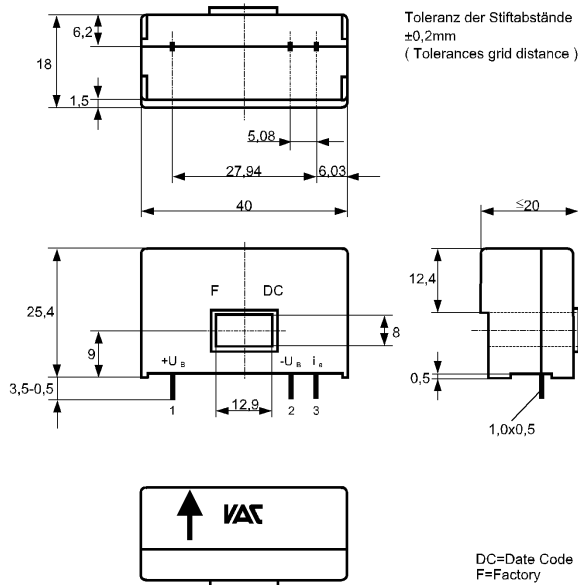

**active current sensors:**  
T60404-N4644-X101  
T60404-N4644-X100

**passive current sensors:**  
not available in this casing

Drawing No. 4

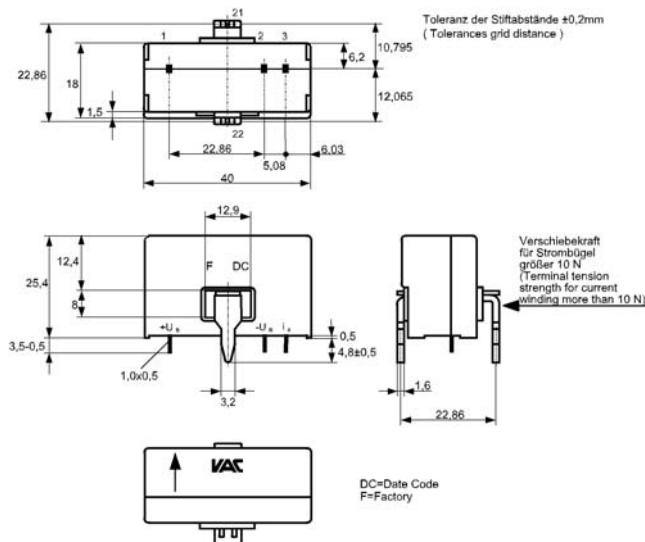

**active current sensors:**  
T60404-N4644-X111  
T60404-N4644-X112

**passive current sensors:**  
not available in this casing

## Drawing No. 5

Anschluß Nr.1,2,3 = 1,0x0,5  
 Anschluß Nr.4,5 = 0,88x0,6  
 ( Connector )  
 Toleranz der Stiftabstände ±0,2mm  
 ( Tolerances grid distance )  
 Befestigungsbohrung  
 □ 3,2 / 13 tief  
 Mounting hole □ 3,2 / 13 deep  
 Schraube Ø 3,9x9,5  
 DIN 7971 empfohlen  
 screw Ø3,9x9,5 recommended

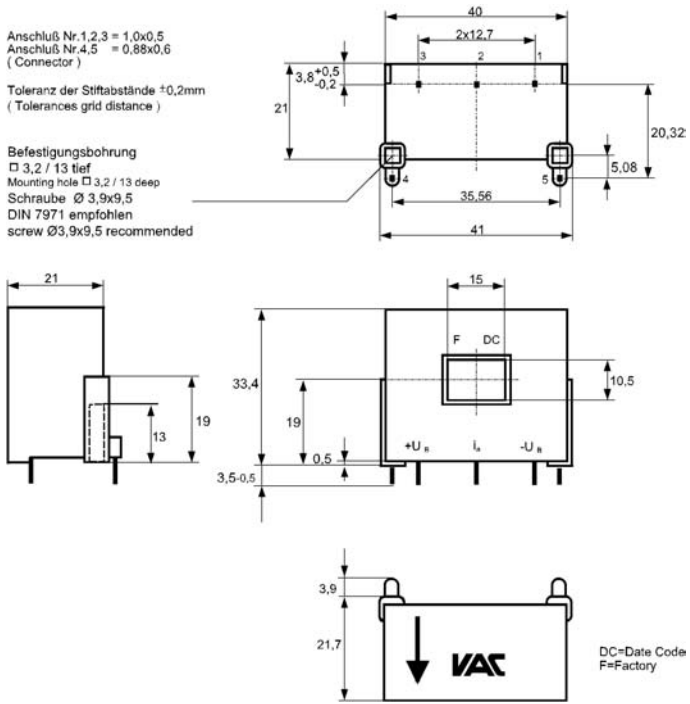

### active current sensors:

T60404-N4644-X200  
 T60404-N4644-X201  
 T60404-N4644-X202

### passive current sensors:

not available in this casing

## Drawing No. 6

DC=Date Code  
 F=Factory

\*=vorläufig  
 (preliminary)

Toleranz der Stiftabstände ±0,3mm  
 ( Tolerances grid distance )

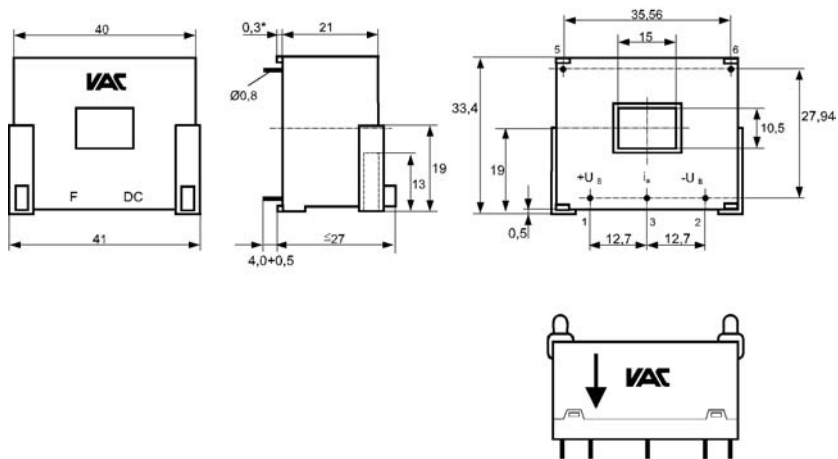

### active current sensors:

T60404-N4644-X271

### passive current sensors:

not available in this casing

## 4.4 DIMENSIONAL DIAGRAMS OF SENSORS

### Drawing No. 7

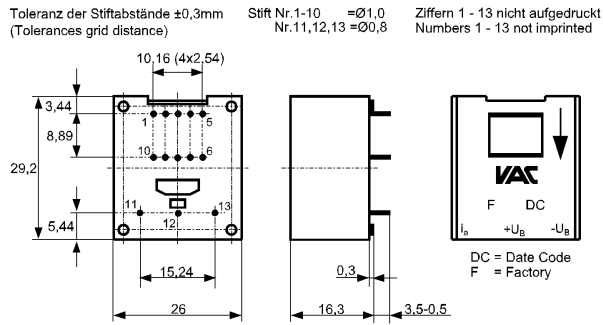

**active current sensors:**  
T60404-N4644-X300

**passive current sensors:**  
not available in this casing

### Drawing No. 8

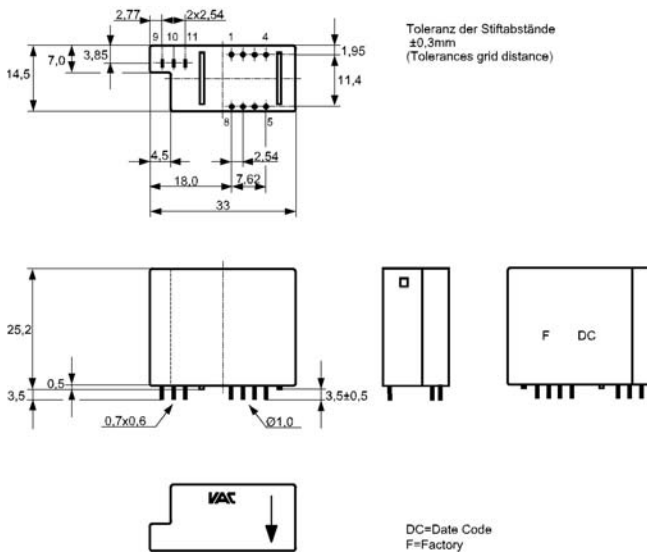

**active current sensors:**  
T60404-N4644-X400

**passive current sensors:**  
not available in this casing

## Drawing No. 9

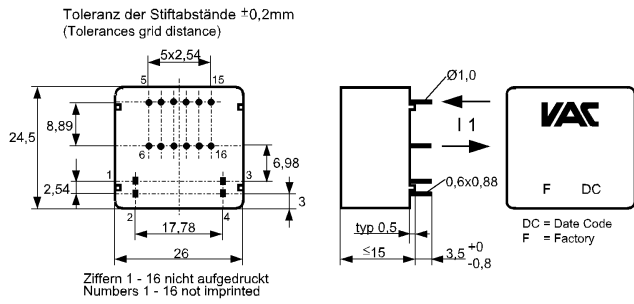

**active current sensors:**  
not available in this casing

**passive current sensors:**  
T60404-N4645-X010  
T60404-N4645-X011  
T60404-N4645-X012

## Drawing No. 10

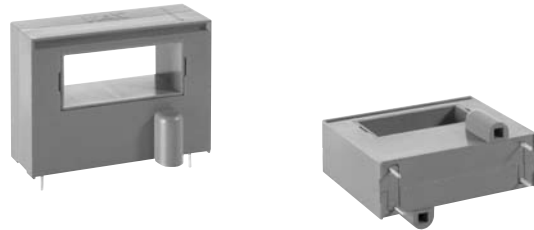
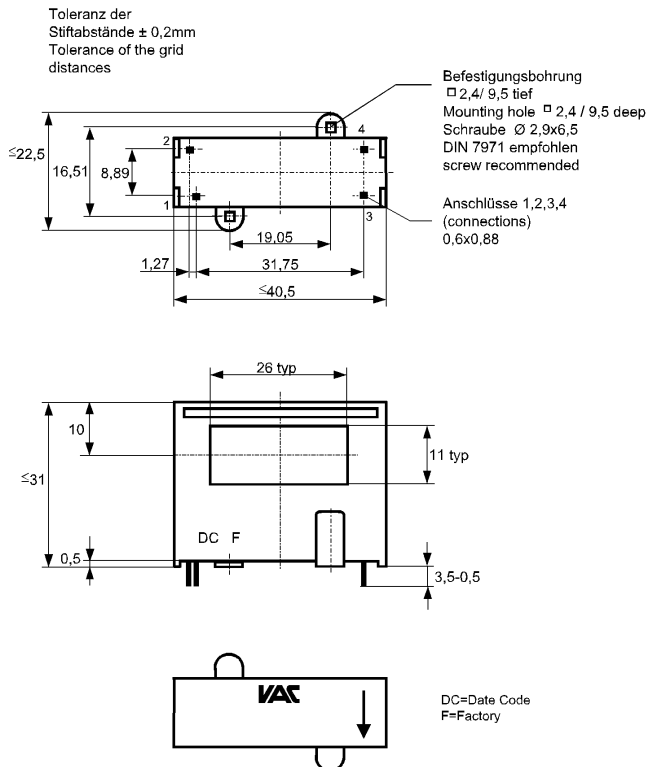

**active current sensors:**  
not available in this casing

**passive current sensors:**  
T60404-N4645-X050  
T60404-N4645-X051

#### 4.4 DIMENSIONAL DIAGRAMS OF SENSORS

Drawing No. 11

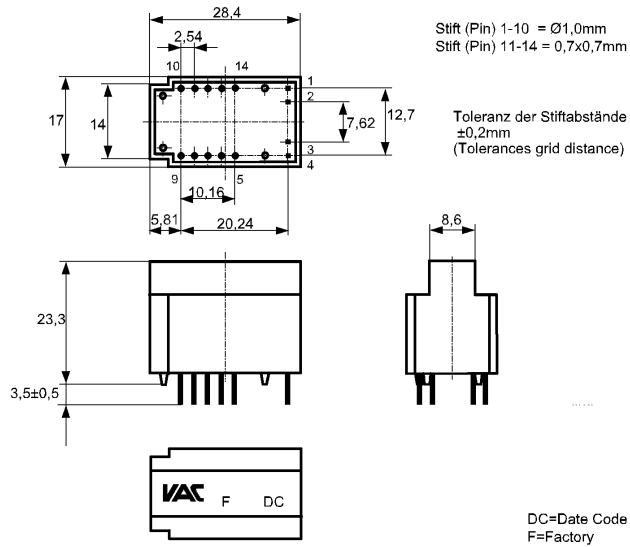

**active current sensors:**  
not available in this casing

**passive current sensors:**  
T60404-N4645-X211

## 5. ABBREVIATIONS AND TERMINOLOGY

Unit	Description
$C_k$	pF Maximum possible coupling capacity (primary - secondary)
$\Delta I_0/\Delta V_C$	mA/V Supply voltage rejection ratio
$\Delta t (I_{p,max})$	$\mu s$ Delay time at $di/dt = 100$ A/ms
$\Delta V_0/\Delta T_A$	$\mu V/^\circ C$ Offset voltage drift @ $T_A=-40\dots+85^\circ C$
$\Delta V_{out}/\Delta T_A$	V/ $\mu s$ Slew rate output voltage
$\Delta \Phi(S1-S2)$	nVs Magnetic flux sensor
$\epsilon_L$	% Linearity
f	kHz Frequency range
$I_0$	mA Offset current @ $I_p=0, T_A=25^\circ C$
$I_{0ges}$	A Offset current (including $I_0, I_{0t}, I_{0T}$ )
$I_{0H}$	mA Hysteresis current @ $I_p=0$ caused by primary current $3 \times I_{PN}$
$I_{0t}$	mA Offset current drift
$I_{0T}$	mA Offset current temperature drift @ $T_A=-40\dots+85^\circ C$
$I_C$	mA Supply current
$I_{comp}$	mA Compensation current
$i_{oss}$	mA Offset ripple
$I_{p,max}$	A maximum measuring range @ $R_M = 100 \Omega$
$I_{PN}$	A Primary rated current, RMS
$I_{S,max}$	mA Maximum output current
$I_{SN}$	A Output rated current, RMS
$K_N$	Transformation ratio
m	g Mass
$P_{VE0}$	mW No load power losses
$P_{VE,max}$	W Maximum permissible power loss @ $T_A=70^\circ C$
$R(S1-S2)$	$\Omega$ Winding resistance magnetic probe coil
$R_M$	$\Omega$ Load resistance
$R_P$	$\Omega$ Primary coil resistance per turn @ $T_A=25^\circ C$
$R_S$	$\Omega$ Secondary coil resistance @ $T_A=85^\circ C$
$R_S(K1-K2)$	$\Omega$ Winding resistance compensation winding

Unit	Description
$T_A$	$^\circ C$ Ambiente temperature
$t_r$	$\mu s$ Response time
$T_S$	$^\circ C$ Storage temperature range
$V_0$	V Offset voltage vs. reference voltage
$V_b$	V Working voltage
$V_c$	V Supply voltage
$V_{Ctot}$	V Maximum supply voltage (without function)
$V_d$	kV Test voltage, RMS, 1s
$V_e$	kV Partial discharge voltage
$V_{K1}$	V Voltage at K1
$V_{out}$	V Output voltage
$V_{Ref}$	V Reference voltage
X	% Measuring accuracy @ $I_{PN}, T_A = 25^\circ C$
$X_{Ti}$	% Temperatur drift of X @ $T_A=-40 \dots +85^\circ C$



**VACUUMSCHMELZE GMBH & CO. KG**

GRÜNER WEG 37  
D-63450 HANAU / GERMANY  
PHONE +49 6181 38 0  
FAX +49 6181 38 2645  
INFO@VACUUMSCHMELZE.COM  
WWW.VACUUMSCHMELZE.COM

**VAC SALES USA LLC**

2935 DOLPHIN DRIVE  
SUITE 102  
42701 ELIZABETHTOWN KY / USA  
PHONE +1270 769-1333  
FAX +1270 765 3118  
INFO-USA@VACUUMSCHMELZE.COM

**VACUUMSCHMELZE  
SALES OFFICE SINGAPORE**

300 BEACH ROAD  
#31-03 THE CONCOURSE  
SINGAPORE 199555  
PHONE +65 6391 2600  
FAX +65 6391 2601  
VAC.SINGAPORE@VACUUMSCHMELZE.COM

**KB - CURRENT SENSORS - EDITION 2007**

Published by VACUUMSCHMELZE GmbH & Co. KG, Hanau  
© VACUUMSCHMELZE 2007. All rights reserved.

As far as patents or other rights of third parties are concerned, liability is only assumed for products per se, not for applications, processes and circuits implemented within these products. The information describes the type of product and shall not be considered as assured characteristics. Terms of delivery and rights to change design reserved.