

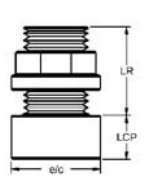



## IMN RP PVC

### MAGNETIC LEVEL SWITCH



General	Operating principle	The IMN level magnetic sensors are based on the action of a reed switch located inside the tube, which is activated by a magnet housed inside the float and moves due to the thrust of the liquid.				
	Application	<ul style="list-style-type: none"> <li>· For the detection of one or more points in liquid level.</li> <li>· Used in maneuvers for filling, emptying, overflow alarm, etc.</li> </ul>				
	Manufacturing	Are customized to suit the installation conditions.				
Housing	Electrical connection	Electrical hose through 1 meter. Other lengths on request				
	Cable material	<b>PVC</b>				
	Temperature (T <sub>a</sub> )	70				
	Nr. maximum cables	7				
	Cable gland	PG7				
Ø Cable hose (mm)	3..6,5 mm					
Body	Guide tube and stops	100..1000 mm. Ø12 mm (PVC) <b>FCPP04M14</b> (PP) 1000..3500 mm. Ø16 mm (PVC) <b>FCPP05M18</b> (PP)				
	Temperature	-10..+60 °C				
	Mounting position	Vertical, ±15°				
Process connection	Thread	1/8"	3/8"	1/2"	3/4"	
	Material	PVC				
	LR (mm)	14	24	25	27	
	LCP (mm)	8	15		11	
	e/c (mm)	16,5	30	12	14	
Floats	Model	<b>FCPP04M14</b>		<b>FCPP05M18</b>		
	Material	PP				
	Dimension (mm)	Ø 29x50		Ø 38x60		
	Pressure (kg/cm <sup>2</sup> )	3				
	Density (g/cm <sup>3</sup> )	e > 0,6		e > 0,5		
	FS / FH (mm)	20 / 30		30 / 30		
		 				
Contacts	Nr. of contacts	1..3 (guided tube Ø12 mm) 1..5 (guided tube Ø16 mm)				
	Class	NO: 120 WVA / 250 VAC-3A NC-NO/NC: 60 WVA / 230 VAC-1A				
	Distance between them	> 40 mm				
Protection	Standard	Normal execution without inner filling. Applicable to most applications.				
	Protected	Anti-condensation effect. In installations where there are large temperature differentials.				
	Insulated	Filled with epoxy resin. Establishing a higher degree of tightness.				

**How to determine the sensor settings**

Determine the total length according to the characteristics of the shell and the liquid level to be controlled.

According to the maneuver you wish to perform, determine the amount, location and type of contacts. Use the table below to define these characteristics.

**Contacts:** To set the type of contact (NO, NC, NONC) should be without the presence of the float. For example, if you want the lower end of the sensor contact opens when the tank runs out of fluid, seek an NC contact for the position.

**Direction of action** (↑ ↓): Set the direction of action of the float (the filling or emptying) allows more precise adjustment of the position of the contacts to the point of desired performance.

**Electrical connection:** If not otherwise specified explicitly, provide a common connection to all the contacts and an active connection for each of them, according to the diagram below.

**Additional floats:** The sensor comes equipped by default with a single float, the lower stop and if required, the upper stop. Can request as many additional floats as many contacts as necessary.

**Conditions of work:** Check that the conditions of pressure, temperature and density of your system match those offered by the model chosen. If you have questions regarding the behavior of materials in contact with the liquid you want to control, see chemical resistance chart on our website.

Apart from the possibilities listed here, there are others such as other floats, various electrical connections, etc. For any of these combinations refer to our document, "Connections and schema IMN" section in our website.

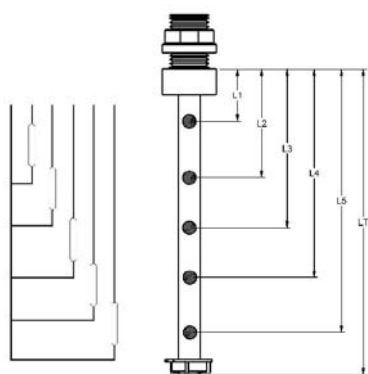

	mm	NO	NC	NONC	↑	↓	Stop
L1							
L2							
L3							
L4							
L5							
LT							

Use this document to define the data of sensor and attach it at the time of ordering. Specify in mm. total length of the sensor.

Specify in mm. the position of each of the contacts used in your application. Place an "X" the type and direction of action of each contact.

In the case of using additional floats, mark an "X" between what contacts should be placed caps separators.

In the composition table references check boxes next to the selected features.

Basic electrical connection

REFERENCE	VERSION	PROCESS	FLOAT	TOTAL LENGTH	Nr. CONTACTS	Nr. FLOATS
IMN RP PVC	<input type="checkbox"/> V1 Standard	<input type="checkbox"/> P01 1/8" G	<input type="checkbox"/> F51 FCPP04M14 <input type="checkbox"/> F52 FCPP05M18	L 100..3500 mm	<input type="checkbox"/> C1 1 contact	<input type="checkbox"/> N1 1 float <input type="checkbox"/> N2 2 floats <input type="checkbox"/> N3 3 floats
	<input type="checkbox"/> V2 Protected	<input type="checkbox"/> P03 3/8" G			<input type="checkbox"/> C2 2 contacts	
	<input type="checkbox"/> V3 Insulated	<input type="checkbox"/> P04 1/2" G			<input type="checkbox"/> C3 3 contacts	
		<input type="checkbox"/> P05 3/4" G			<input type="checkbox"/> C4 4 contacts	
					<input type="checkbox"/> C5 5 contacts	

To compose a reference, select an option from each of the columns. Example: IMN RP PVC V1 P03 F51 L500 C1 N1

Installations advise	Installation in areas with turbulence
<p>If the tank is metal walls, the probe will separate from them at least 100 mm.</p> <p>The maximum slope should be ±15°</p>	<p>Place the sensor as far as possible from areas of turbulence.</p> <p>Still pipe. Protects the race of the float of the turbulence.</p> <p>Separating wall or discouragement.</p> <p>PSIA, DSIA relay: Differential control of max. and min. by timing.</p>

ELECTRICAL CONNECTION EXAMPLES

1 CONTACT



CNX1



CNX2



CNX3

5 CONTACTS

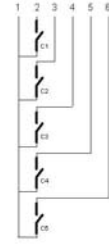

CNX86

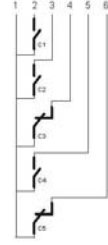

CNX87

2 CONTACTS



CNX4

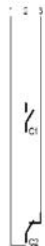

CNX5

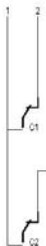

CNX6

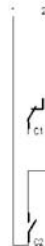

CNX7

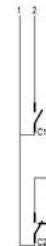

CNX8

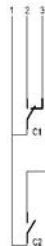

CNX9

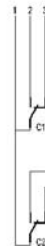

CNX10



CNX11

3 CONTACTS



CNX12



CNX13



CNX14



CNX15



CNX16



CNX17



CNX18



CNX19



CNX20



CNX21



CNX22



CNX23

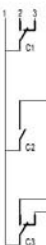

CNX24



CNX25



CNX26

4 CONTACTS



CNX27

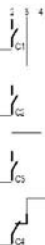

CNX28

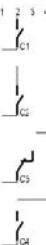

CNX29



CNX30



CNX31

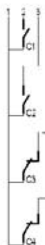

CNX32

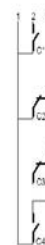

CNX33



CNX34

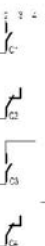

CNX35



CNX36



CNX37

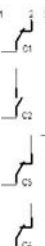

CNX38

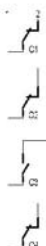

CNX39

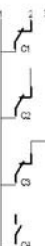

CNX40

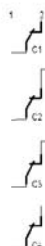

CNX41



CNX42

More information regarding, in "Utilities / Tables" on our website ([www.disibeint.com](http://www.disibeint.com))

APPLICATION EXAMPLES

1 CONTACT

CONTROL TO ONE MAXIMUM OR MINIMUM LEVEL

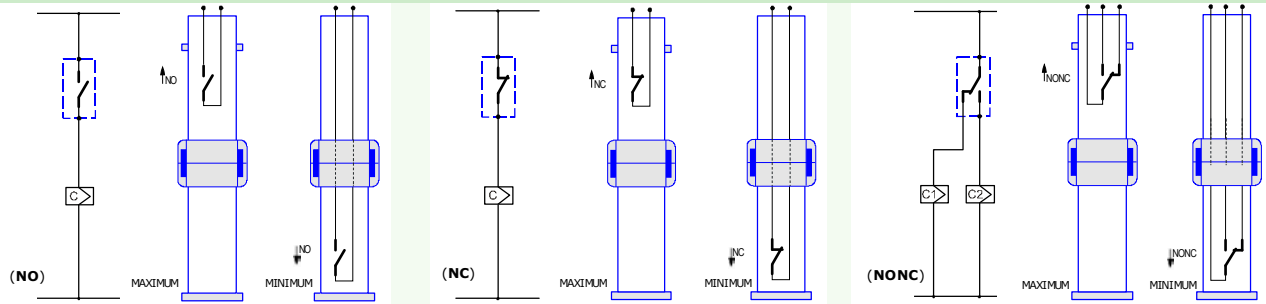

2 CONTACTS

START-STOP WITH INTERLOCK

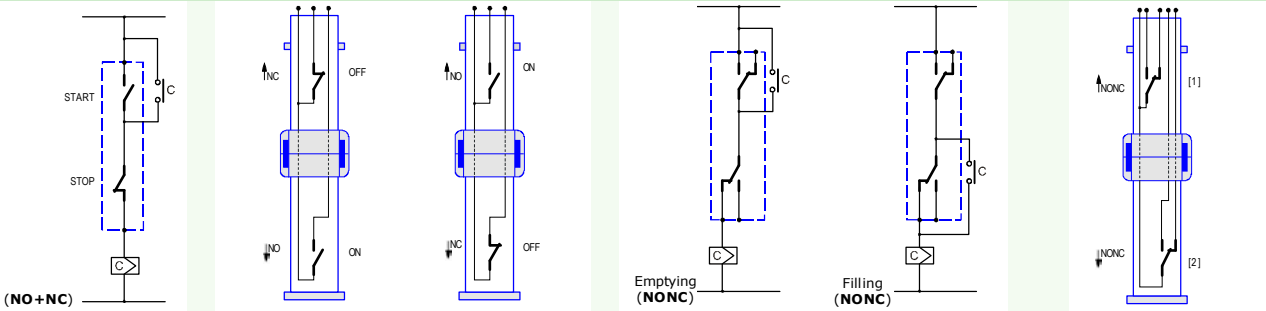

3 CONTACTS

START-STOP EMPTYING + LEVEL MINIMUM ALARM

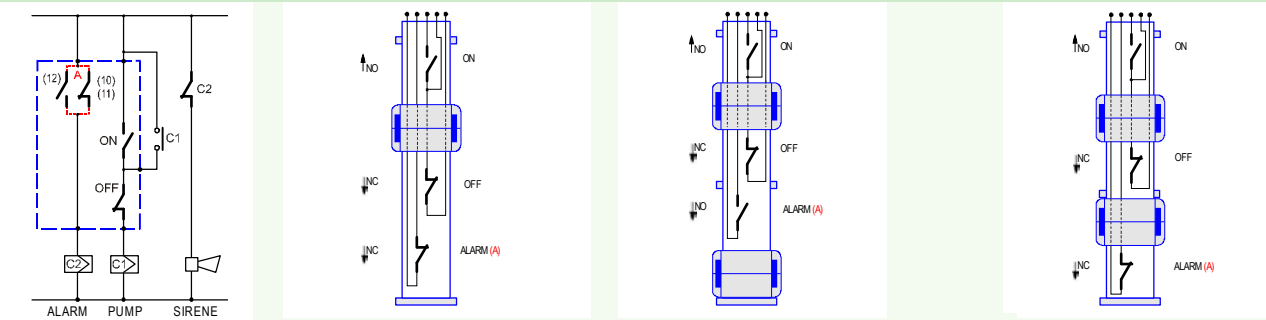

4 CONTACTS

START-STOP FILLING + OVERFLOW ALARM

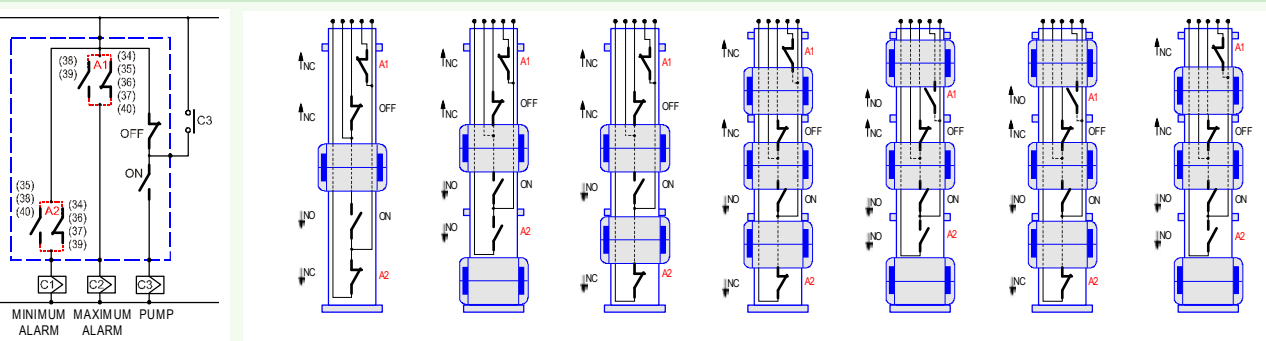

5 CONTACTS

INDICATION or CONNECTION to PLC

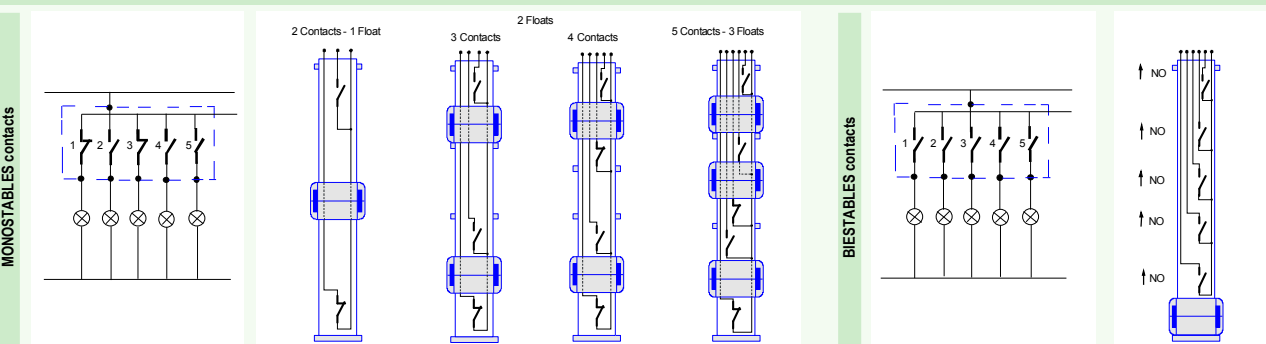

More related information in "Utilities / Tables" on our website ([www.disibeint.com](http://www.disibeint.com))